



2018'

CUTTING TOOLS

- TURNING
- BORING
- THREADING
- GROOVING
- MILLING
- DRILLING



**ZHUZHOU CEMENTED CARBIDE
CUTTING TOOLS CO., LTD.**

Brief introduction

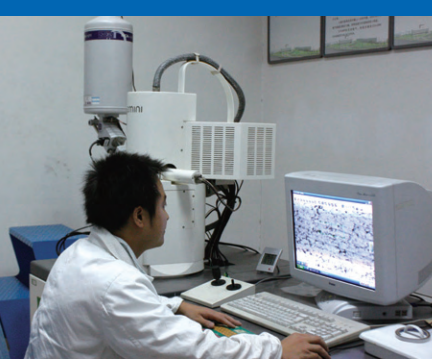

Zhuzhou Cemented Carbide Cutting Tools Co.,Ltd. (**ZCC·CT**) is a subsidiary company of Zhuzhou Cemented Carbide Group Corp.Ltd.(zcc), located in Hunan province, China.

With 60 years experience in the manufacture of cemented carbide products, a team of enthusiastic design engineers, and the world's most advanced technology and equipment, **ZCC·CT** has created the perfect combination required to lead China in the production and distribution of highly productive, superior quality carbide cutting tools long into the future.

History of **ZCC·CT**

- 1954 - Zhuzhou Cemented Carbide Works founded cemented carbide production in China.
- 1988 - Introduced advanced technology and equipment to produce high precision indexable cemented carbide inserts for metal cutting.
- 1992 - Solid carbide cutting tools and end mill production line were started with the introduction of international technology and equipment.
- 2002 - Zhuzhou Cemented Carbide Cutting Tools Co Ltd.was founded. Cemented carbide indexable insert production line, and solid carbide cutting tool production line were transformed by the introduction of advanced technology and processing equipment sourced from respected international suppliers. The research and development section was enhanced through the introduction of an ever-growing team of highly skilled engineers working full time to improve and expand the range of solid carbide cutting tools, indexable inserts, and toolholding systems.
- 2005 - Further introduction of advanced technology and equipment for the production of ceramic inserts adds another dimension to **ZCC·CT**

Research and Development

A highly trained R & D staff work hard continuously in the field of cutting tool substrate material development, coating material technology, and insert chipbreaker design.

They also conduct testing and evaluations of newly designed tools prior to market introduction.

ZCC·CT 's research & development center is the most advanced and modern scientific research base in China for promoting the development of cemented carbide cutting tools.



Contents

GENERAL TURNING TOOLS

P1-117

PARTING, GROOVING TOOLS

P118-143

THREADING TOOLS

P144-183

MILLING TOOLS

P184-284

SOLID CARBIDE CUTTING TOOLS

P285-329

BORING TOOLS

P330-393

- This catalog shows basic types of standard series inserts and cutting tools. If you have any questions or feedback, please feel free to contact our Sales Department. We will try our best to satisfy you.
- All information in this catalog relates to current products. We will improve our products as our technology develops.
- All technical data in this catalog is prescribed for given working conditions. Please use it as a reference for your own working conditions.

A

B

C

D

E

F

Turning Tools

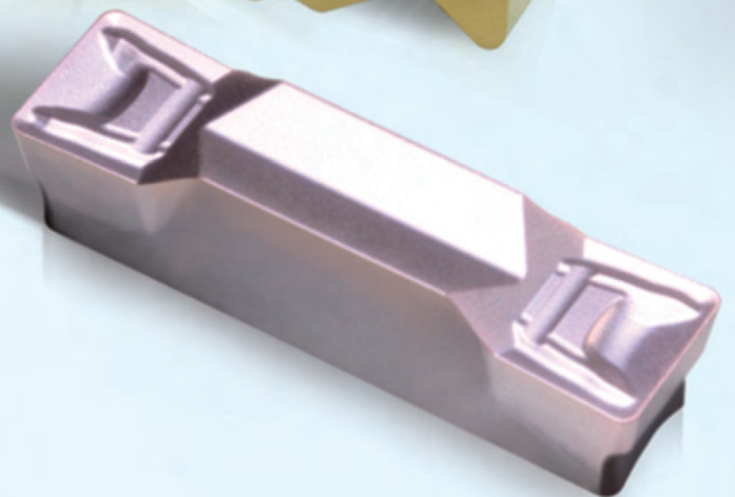
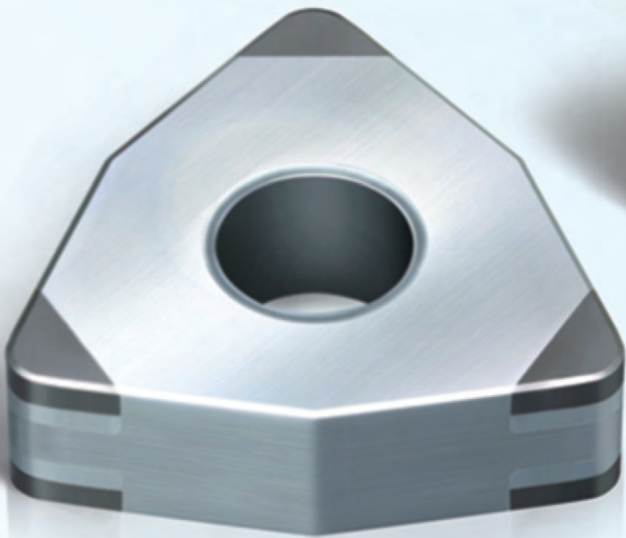
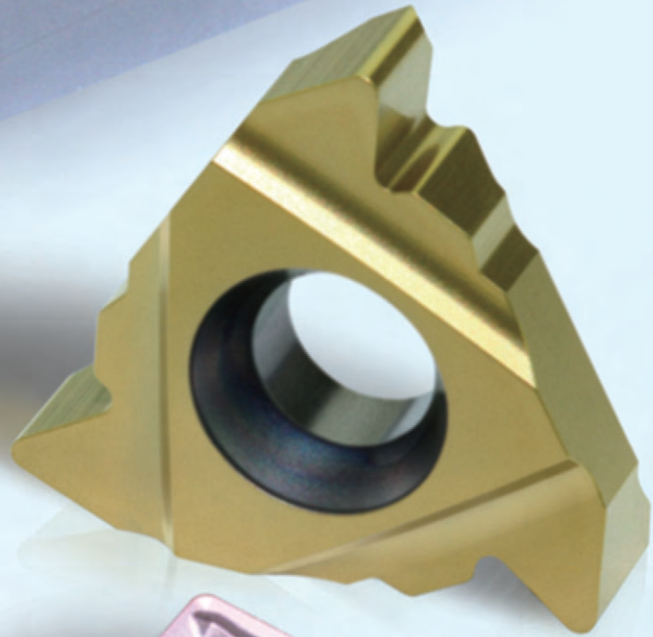

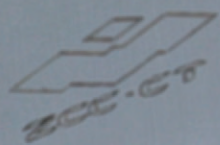

DV JNR2525M16
40529344

V16BM CM5*22C SM5*8.65XA1 SPR6 C6RA



DC
40



Turning

GENERAL TURNING TOOLS

Overview of turning inserts/tools	P2-7
Table of recommended grades for turning	P8
Introduction of chip-breakers in turning operations	P9-13
Main grades and applications	P14-27
Turning insert code key	P28-29
Negative turning inserts	P30-57
Positive turning inserts	P58-72
PCBN&PCD inserts	P73-93
Turning Toolholders Code Key	P94-95
Turning Toolholders	P96-106
Boring Bars Code Key	P108
Boring Bars	P109-117

Product overview

Turning inserts

For finishing

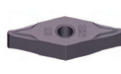

DNEG-NGF

VNEG-NGF

CNMG-DF

CNMG-SF

CNMG-EF

CNEG-NF

DNMG-DF

Page

P36

P52

P30

P30

P30

P30

P35

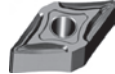
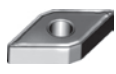

DNMG-SF

DNMG-EF

DNEG-NF

SNMG-DF

SNMG-EF

SNMG-SF

TNMG-DF

TNMG-SF

Page

P35

P36

P36

P41

P41

P41

P47

P47

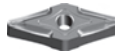

TNMG-EF

VNMG-DF

VNMG-EF

VNEG-NF

VNMG-SF

WNMG-DF

WNMG-SF

WNMG-EF

Page

P47

P52

P52

P52

P52

P54

P54

P55



Wiper



WNEG-NF

CNMG-WGF

DNMX-WGF

TNMX-WGF

WNMG-WGF

CNMG-WGM

Page

P55

P30

P35

P47

P54

P32

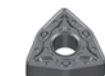
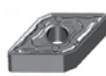

DNMX-WGM

TNMX-WGM

WNMG-WGM

Page

P37

P48

P55

For semi-finishing

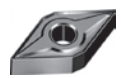

CNMG-PM

CNMG-DM

CNMG-EM

CNMG-NM

DNMG-PM

DNMG-DM

DNMG-EM

Page

P31

P31

P32

P32

P37

P38

P38

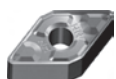

DNMG-NM

SNMG-PM

SNMG-DM

SNMG-EM

SNMG-NM

TNMG-PM

TNMG-DM

TNMG-EM

Page

P39

P41

P42

P42

P42

P48

P48

P49



VNMG-PM

VNMG-DM

VNMG-EM

VNMG-NM

WNMG-PM

WNMG-DM

WNMG-EM

WNMG-NM

Page

P53

P53

P53

P53

P56

P55

P56

P56

Negative inserts



Negative inserts

For roughing

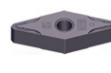
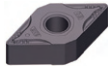

CNMG-SNR

DNMG-SNR

SNMG-SNR

TNMG-SNR

VNMG-SNR

WNMG-SNR

Page

P33

P40

P44

P50

P53

P57

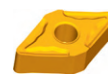

CNMG-DR

CNMM-DR

CNMG-ER

CNMM-ER

DNMG-DR

DNMM-DR

DNMG-ER

DNMM-ER

Page

P32

P33

P33

P33

P39

P39

P39

P40



SNMG-DR

SNMM-DR

SNMG-ER

SNMM-ER

TNMG-DR

TNMM-DR

TNMG-ER

WNMG-DR

Page

P43

P43

P44

P44

P49

P49

P49

P57

Conventional chipbreaker

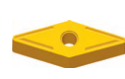

CNMG

DNMG

SNMG

SNMM

TNMG

TNMM

VNMG

Page

P34

P40

P45

P45

P50

P51

P53

Without chipbreaker (flat top)



CNMA

DNMA

SNMA

SNGN/SNUN

TNMA

WNMA

Page

P34

P40

P45

P46

P51

P57

Positive inserts

For fine finishing

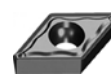
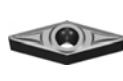
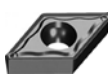

CCGT-SF

DCGT-SF

VCGT-SF

CPGT-SF

DPGT-SF

TPGT-SF

TPGH-L

Page

P58

P60

P67

P70

P71

P72

P72

For finishing

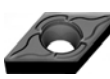
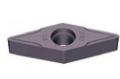
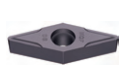

VCGT-NGF

VBET-NGF

CCMT-HF

CCMT-EF

DCMT-HF

DCMT-EF

SCMT-HF

Page

P67

P69

P58

P58

P60

P60

P62

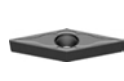

SCMT-EF

TCMT-HF

TCMT-EF

VCGT-HF

VBMT-HF

VBMT-EF

Page

P62

P64

P64

P67

P69

P69

For semi-finishing

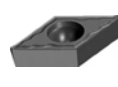

CCMT-HM

CCMT-EM

DCMT-HM

DCMT-EM

SCMT-HM

SCMT-EM

TCMT-HM

Page

P58

P59

P60

P60

P62

P62

P65

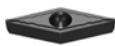

TCMT-EM

VBMT-HM

VBMT-EM

Page

P64

P69

P69

For roughing



VBMT-SNR

CCMT-HR

DCMT-HR

SCMT-HR

TCMT-HR

VBMT-HR

Page

P69

P59

P61

P62

P65

P69

For Al machining

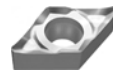

CCGX-LC

CCGX-LH

DCGX-LC

DCGX-LH

SCGX-LC

SCGX-LH

TCGX-LC

Page

P59

P59

P61

P61

P63

P63

P65



TCGX-LH

VCGX-LC

VCGX-LH

Page

P66

P68

P68

Conventional chipbreaker



SCMT

TCMT





Page

P63





P66

PCBN&PCD inserts









Negative inserts

				
CNGA	DNGA	TNGA	VNGA	WNGA
Page P78	P80	P83	P84	P85

PCBN inserts turning case

			
CNGN	DNGN	SNGN	RNGN
Page P79	P81	P82	P86

Positive inserts







							
CCGW	CCMX	DCGW	DCMX	TCGW	TCMX	VBGW	VBMX
Page P87	P88	P89	P89	P90	P91	P92	P92







	
VCGW	VCMX
Page P93	P93

A

Parting and grooving inserts

Little squirrel series

					
ZP□D-MG	ZP□S-MG	ZT□D-MG	ZT□S-MG	ZT□D-MM	ZT□D-EG
P127	P127	P128	P128	P128	P129

					
ZT□D-EG	ZIMF-SM	ZR□D-MG	ZR□D-NM	ZR□D-EG	ZIGQ-NF
P129	P129	P130	P130	P131	P131

Threading inserts

Right hand type	ISO metric thread		General pitch thread		Whitworth thread	
						
	External thread	Internal thread	External thread	Internal thread	External thread	Internal thread
Page	P154	P155	P156	P156	P157	P157

Right hand type	Unified thread		British standard taper pipe threads		NPT American standard taper pipe threads	
						
	External thread	Internal thread	External thread	Internal thread	External thread	Internal thread
Page	P158	P158	P159	P159	P160	P160

Right hand type	American standard aerospace and aviation threads		American ACME		American STUB-ACME (Short tooth threads)	
						
	External thread		External thread	Internal thread	External thread	Internal thread
Page	P161		P162	P162	P163	P163

Right hand type	API 60°		API Round		API Buttress Casing	
						
	External thread	Internal thread	External thread	Internal thread	External thread	Internal thread
Page	P164	P164	P165	P165	P166	P166

Right hand type	ISO metric thread Full Form(Thin type)		General pitch thread Without end(Thin type)		Whitworth thread(Thin type)	
Thin type						
	External thread	Internal thread	External thread	Internal thread	External thread	Internal thread
Page	P167	P168	P169	P169	P170	P170

Right hand type	Unified thread(Thin type)		British standard taper pipe threads (Thin type)		American standard taper pipe threads (Thin type)	
						
	External thread	Internal thread	External thread	Internal thread	External thread	Internal thread
Page	P171	P171	P172	P172	P173	P173

Turning toolholders

External turning toolholders

D-Multi clamp

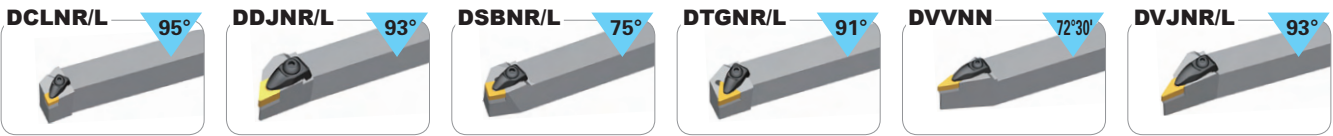

Page P96 P97 P97 P98 P98 P99

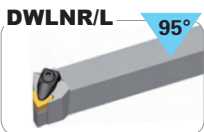

Page P99

M-Multi clamp

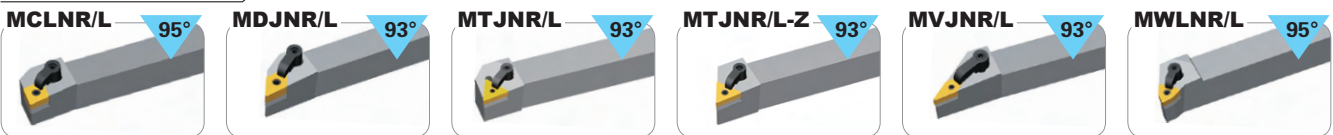

Page P100 P100 P101 P101 P102 P102

S-Screw clamp

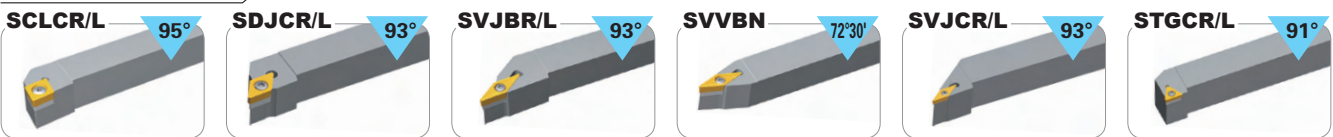

Page P103 P103 P104 P104 P105 P106

Boring Bars

P-Lever clamp



P109 P109 P110 P110 P111

S-Screw clamp

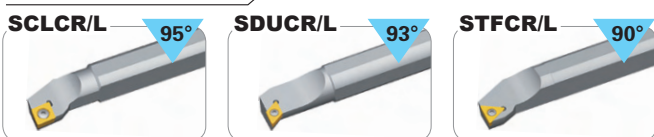

P112 P113 P114

Threading tools



P176 P177 P178 P178













A

Table of recommended grades for turning inserts

ISO	General turning							Threading	Parting and grooving			
	Code	Coated grade		Cermet	Coated cermet	Cemented carbide	PCBN		PCD	Coating		Cemented carbide
		CVD	PVD							PVD	CVD	
P Steel	01											
	10	YBC151										
	20	YBC251	YBC152									
	30		YBC252									
	40		YBC351	YBC352								
M Stainless steel	01											
	10	YBM151										
	20	YBM251										
	30	YBM253										
	40											
K Cast iron	01											
	10	YBD052	YBD102									
	20		YBD152									
	30		YBD252									
	40											
N non-ferrite materials	01											
	10											
	20											
	30											
	40											
S Heat-resistant steel	01											
	10		YBG102									
	20		YBG105									
	30		YBG212	YBG202								
	40											
H Hardened material	01											
	10											
	20											
	30											
	40											

Introduction of chip-breakers























Negative inserts with a hole

Application	Chipbreaker	Precision	Recommended cutting parameters	Feature/Shape of insert
For finishing	SF 	M	$a_p=0.002\sim0.039(\text{inch})$ $f_n=0.002\sim0.014(\text{inch/r})$	Recommended chipbreaker for fine-finishing P-kind soft steel Double-side chipbreaker with M-class tolerance has outstanding performance on machining P kind soft steel and medium-carbon steel to ensure high surface quality. 
	DF 	M	$a_p=0.012\sim0.079(\text{inch})$ $f_n=0.002\sim0.014(\text{inch/r})$	Recommended chipbreaker for finishing P-kind materials Double-side chipbreaker with M-class tolerance for finish machining carbon and alloy steels. 
	EF 	M	$a_p=0.002\sim0.039(\text{inch})$ $f_n=0.002\sim0.012(\text{inch/r})$	Recommended chipbreaker for finishing M-kind materials Double-side chipbreaker with M-class tolerance with sharp edge for machining stainless steel to reduce built-up edge and work-hardening, while improving surface finish. 
	NF 	E	$a_p=0.004\sim0.039(\text{inch})$ $f_n=0.002\sim0.012(\text{inch/r})$	Recommended chipbreaker for finishing S-kind materials Double-side chipbreaker with E-class precision, for holding close tolerance when indexing. Wear resistance and work hardening resistance combine to achieve high machining precision. 
	NG F 	E	$a_p=0.004\sim0.039(\text{inch})$ $f_n=0.002\sim0.012(\text{inch/r})$	Recommended chipbreaker for general finishing of S- materials E-class double side chip breaker with excellent sharp edge. High positioning accuracy, light cutting force. -NGF is recommended chip breaker for S series material general finishing. 
	Wiper	WG F 	M	$a_p=0.012\sim0.079(\text{inch})$ $f_n=0.004\sim0.016(\text{inch/r})$
For semi-finishing		DM 	M	$a_p=0.059\sim0.197(\text{inch})$ $f_n=0.006\sim0.020(\text{inch/r})$
	PM 	M	$a_p=0.059\sim0.197(\text{inch})$ $f_n=0.006\sim0.020(\text{inch/r})$	Recommended chipbreaker for semi-finishing P-kind materials Double-side chipbreaker with M-class tolerance has higher toughness on cutting edge than DM chipbreaker. It's suitable for semi-finishing under unfavorable conditions. Also good for machining cast iron with low cutting force. 









Introduction of chip-breakers

Negative inserts with a hole

Application	Chipbreaker	Precision	Recommended cutting parameters	Feature/Shape of insert
For semi-finishing			$a_p=0.004\sim0.059(\text{inch})$ $f_n=0.002\sim0.012(\text{inch/r})$	Recommended chipbreaker for semi-finishing S-kind materials Double-side chipbreaker with M-class tolerance with good capability to prevent wear and work-hardening when machining low-machinability rated metals. Possesses higher feed and depth of cut capability than NF chipbreaker. 
			$a_p=0.012\sim0.079(\text{inch})$ $f_n=0.004\sim0.016(\text{inch/r})$	Wiper chipbreaker for semi-finishing Double-sided chipbreaker with M-level tolerance, semi-finishing chipbreaker with wiper designed, perfect combination of good wiper result and sturdy cutting edge structure, which perfectly meet the requirement of high efficiency and good surface quality. 
			$a_p=0.020\sim0.059(\text{inch})$ $f_n=0.004\sim0.012(\text{inch/r})$	Recommended chipbreaker for semi-finishing M-kind materials Double-side chipbreaker with M-class tolerance serves to reduce cutting force and workpiece adhesion when machining stainless steel. Possesses higher feed and depth of cut capability than EF chipbreaker. 
			$a_p=0.059\sim0.197(\text{inch})$ $f_n=0.008\sim0.020(\text{inch/r})$	For machining P-kind, M-kind, K-kind materials from semifinishing to roughing Double-side chipbreaker with M-class tolerance has good cutting edge toughness with wide application area. Unfavorable chip control compared to dedicated chipbreakers. 
Light-load roughing			$a_p=0.118\sim0.472(\text{inch})$ $f_n=0.012\sim0.031(\text{inch/r})$	Recommended chipbreaker for light-load roughing of P-kind and K-kind materials Double-side chipbreaker with M-class tolerance for light roughing, higher metal removal rate, and greater cutting edge security. 
			$a_p=0.118\sim0.591(\text{inch})$ $f_n=0.012\sim0.031(\text{inch/r})$	Recommended chipbreaker for roughing P-kind materials Single-side chipbreaker with M-class tolerance has high security on cutting edge for higher removal rates and low cutting force at large cutting depth and high feed rates. 
For roughing			Double sided $a_p=0.098\sim0.315(\text{inch})$ $f_n=0.008\sim0.024(\text{inch/r})$ Single sided $a_p=0.098\sim0.787(\text{inch})$ $f_n=0.008\sim0.047(\text{inch/r})$	Recommended chipbreaker for roughing M-kind materials Single/Double side chipbreaker with M-class tolerance has good impact-resistance. The chipbreaker's cutting edge is designed to balance security and sharpness. High performance is achieved by reducing edge build-up and reducing heat when roughing stainless steel. 
			$a_p=0.020\sim0.118(\text{inch})$ $f_n=0.002\sim0.012(\text{inch/r})$	Recommended chipbreaker for S-material high efficiency roughing M-level double-sided chipbreaker perfectly combines sharpness and strength of the cutting edge, with small cutting resistance and high edge strength can effectively reduce groove wear. SNR is recommended chipbreaker for high depth roughing of S- materials. 

Introduction of chip-breakers









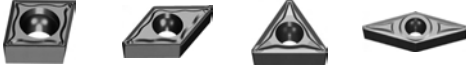

Negative inserts with a hole

Application	Chipbreaker	Precision	Recommended cutting parameters	Feature/Shape of insert
Heavy-load machining		M	$a_p=0.197\sim0.591(\text{inch})$ $f_n=0.012\sim0.039(\text{inch/r})$	<p>Recommended chipbreaker for heavy-load machining P-kind materials Single-side chipbreaker with M-class tolerance has high strength and security on cutting edge, with strong capability to prevent plastic-deformation under high metal removing rate.</p> 
Cast iron machining		M	$a_p=0.012\sim0.472(\text{inch})$ $f_n=0.002\sim0.024(\text{inch/r})$	<p>For machining cast iron Double-side with M-class tolerance has high cutting edge strength to effectively machine through workpiece imperfections, such as sand pockets in cast iron.</p> 
Super hard inserts		G	$a_p=0.002\sim0.020(\text{inch})$ $f_n=0.002\sim0.012(\text{inch/r})$	<p>For machining non-ferrous metal and high-hardness material G-class tolerance is the best choice for machining nonferrous metals with high-hardness materials by soldering PCBN and PCD onto cemented carbide substrate.</p> 

















Introduction of chip-breakers

Positive inserts with a hole

Application	Chipbreaker	Precision	Recommended cutting parameters	Feature/Shape of insert
For extra finishing	SF 	G	$a_p=0.002\sim0.039(\text{inch})$ $f_n=0.002\sim0.012(\text{inch/r})$	First choice for finish machining G-class tolerance is recommended for precision finishing. 
	HF 	M	$a_p=0.004\sim0.079(\text{inch})$ $f_n=0.002\sim0.012(\text{inch/r})$	Chipbreaker for finishing with wide application With M-class tolerance suitable for internal and external finishing machining for various materials such as steel and cast iron etc. 
For finishing	EF 	M	$a_p=0.004\sim0.079(\text{inch})$ $f_n=0.002\sim0.012(\text{inch/r})$	Recommended chipbreaker for finishing M-kind materials M-class tolerance; sharp cutting edge suitable for finishing materials as stainless steel and soft steel, etc. where edge build-up is problem. 
	NGF 	E G	$a_p=0.004\sim0.039(\text{inch})$ $f_n=0.002\sim0.012(\text{inch/r})$	Recommended chipbreaker for S-material general finishing E, G grade accuracy, for inner hole finishing of S materials. 
For semi-finishing	HM 	M	$a_p=0.039\sim0.157(\text{inch})$ $f_n=0.008\sim0.020(\text{inch/r})$	Chipbreaker for semi-finishing with wide application M-class tolerance; suitable for boring and o.d. semi-finishing materials, like steel and cast iron etc. 
	EM 	M	$a_p=0.039\sim0.157(\text{inch})$ $f_n=0.008\sim0.020(\text{inch/r})$	Recommended chipbreaker for semi-finishing M-kind materials M-class tolerance; higher toughness on cutting edge than EF chipbreaker for higher feed and depth of cut. 

Introduction of chip-breakers

Positive inserts with a hole

Application	Chipbreaker	Precision	Recommended cutting parameters	Feature/Shape of insert
For roughing			$a_p=0.118\sim0.276(\text{inch})$ $f_n=0.012\sim0.028(\text{inch/r})$	General chipbreaker for roughing M-class tolerance; suitable for both boring and o.d. roughing materials as steel, stainless steel and cast iron etc. 
			$a_p=0.02\sim0.118(\text{inch})$ $f_n=0.002\sim0.012(\text{inch/r})$	Recommended chipbreaker for S-material high-efficiency roughing M-level accuracy, for inner hole roughing of S materials. 
For Al machining			$a_p=0.02\sim0.189(\text{inch})$ $f_n=0.002\sim0.020(\text{inch/r})$	Chipbreaker for machining Al G-class tolerance, large rake angle and large clearance angle combine for positive cutting action, with good chip control. 
			$a_p=0.004\sim0.315(\text{inch})$ $f_n=0.002\sim0.016(\text{inch/r})$	Unique chipbreaker for machining AL alloy G-class tolerance, big rake angle and surface polishing, prevents built-up edge, allowing for high surface workpiece quality and long tool life. 
Super hard inserts			$a_p=0.002\sim0.020(\text{inch})$ $f_n=0.002\sim0.012(\text{inch/r})$	For nonferrous metals and materials with high hardness G-class tolerance; for machining nonferrous metals and materials with high hardness by soldering PCBN and PCD material to cemented carbide substrate. 



Main chip breaking range reference for general turning inserts

Negative inserts

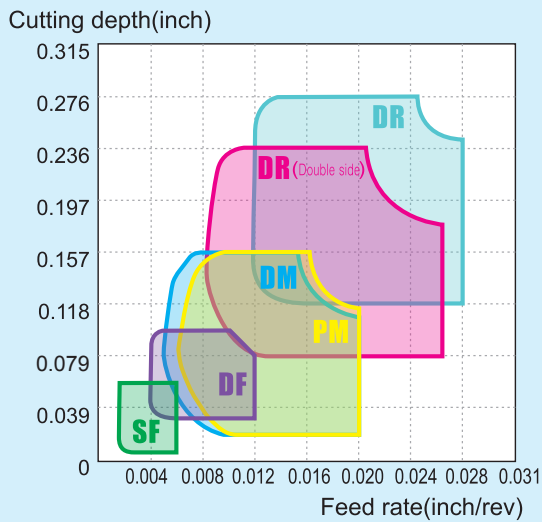

▶ Workpiece material: 45# steel

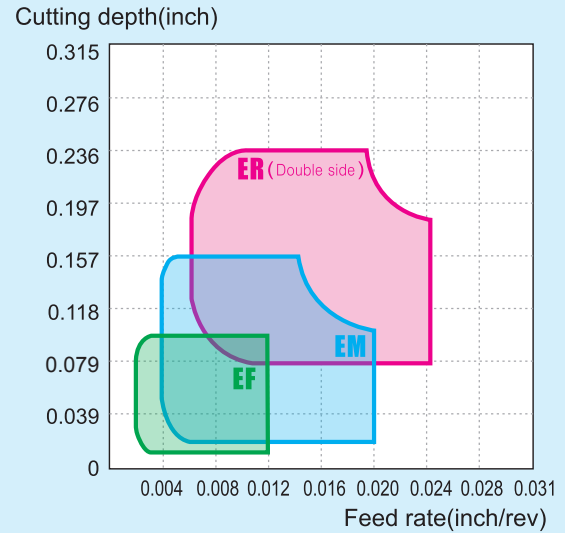

▶ Workpiece material: stainless steel (Austenitic 321)

Positive inserts

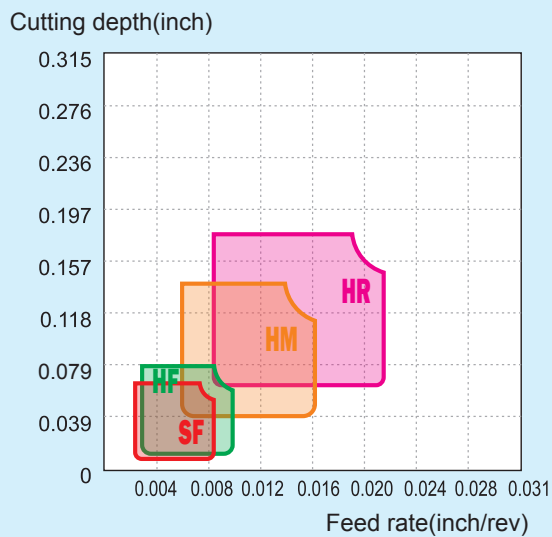

▶ Workpiece material: 45# steel

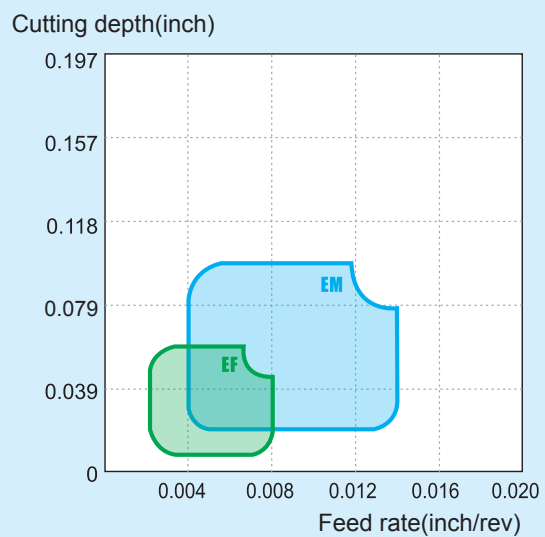

▶ Workpiece material: stainless steel (Austenitic 321)

-EF -EM -ER

Specially designed for machining intensively adhesive and high-plasticity materials such as stainless steel, etc

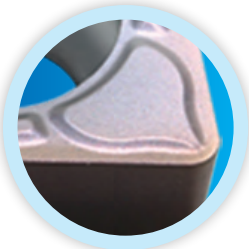

-EF

Rake angle and inclined angle are specially designed for intensively adhesive stainless steel and high-plasticity materials which are hard to be machined. Sharp cutting edge enables it to cut lightly and easily and achieve good surface quality by well controlling chip breaking. It is especially suitable for finishing these kinds of materials.

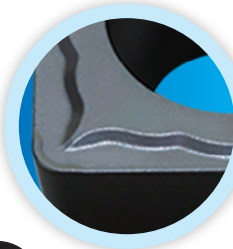

-EM

Inserts meet the requirements of machining intensively adhesive materials. Impact resistance of cutting edge is improved in addition to sharpness, which makes it suitable for semi-finishing and intermittent machining of adhesive materials such as austenitic stainless steel, etc.

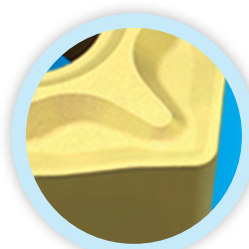
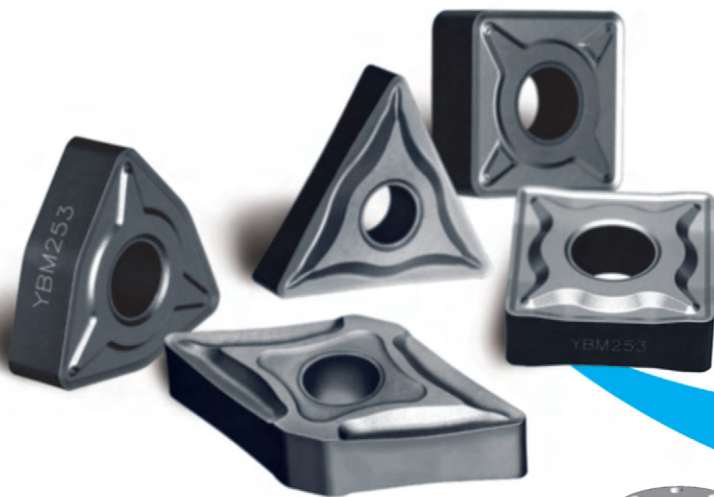

-ER

Specially designed double rake angle with wide land achieves balance between edge security and sharpness, and effectively reduces cutting resistance and wear on groove.

Number of machined parts / Cutting edge

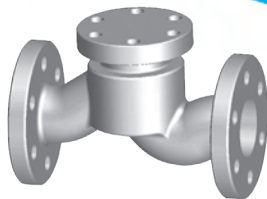
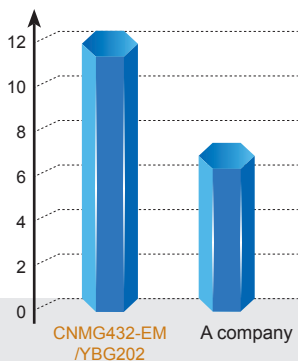

Machining external of valve

Machining end surface of valve (intermittent machining)
Workpiece diameter: 5.3in
Rotating speed: 350 rpm
Feed rate: 0.01in/r
Cutting depth: 0.059in

Number of machined parts / Cutting edge

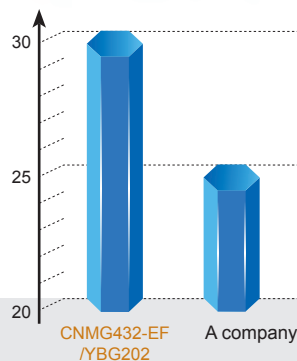

Machining external of valve
Workpiece diameter: 3.5in
Rotating speed: 635rpm
Feed rate: 0.006in/r
Cutting depth: 0.039in

At the Cutting Edge of Grade and Coating Technology

For parting, grooving and the machining of difficult to machine materials.

Nano structure nc-TiAlN coating grade

- ✔ Smooth coating surface results in less friction and easier chip flow.
- ✔ Special Nano structure coating ensures higher toughness, hardness, and bonding to substrate.
- ✔ Thermal and chemical stability of coating allow cutting edges to remain reliable throughout cut.

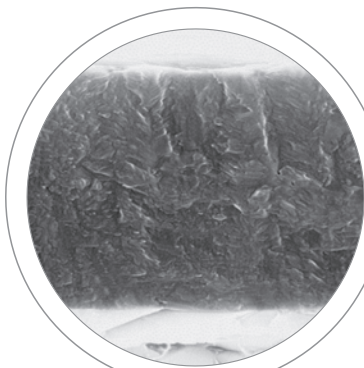
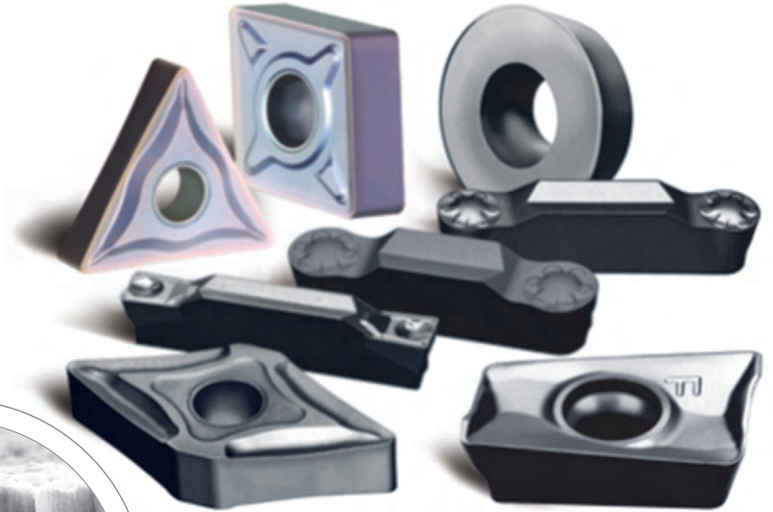

nc-TiAlN coating



Common TiAlN coating

YBG102 YBG202 YBG205 YBG302
YBG105 YBG212

Second generation of **YBC**

BLACK DIAMOND INSERTS

Achieving both higher cutting speed and longer tool life

Perfect unification of toughness and anti-plastic deformation. Specially designed cutting edge with "skeleton" realizes perfect unification of toughness and anti-plastic deformation.

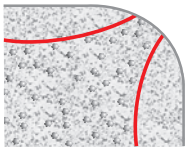

Roughness of insert surface is improved after special treatment on surface, which effectively reduces cutting forces, prevents workpiece adhering to surface of inserts and improves operation stability of inserts.

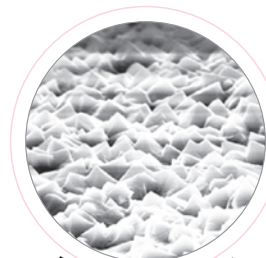

Before surface treatment



After surface treatment

The perfect combination of fibrous TiCN and fine grain Al_2O_3 obviously improves abrasion resistance and anti-breakage of inserts.

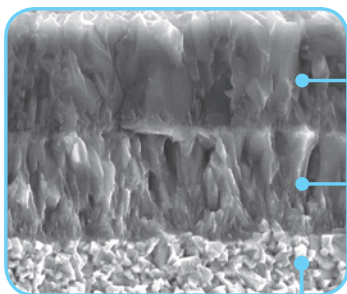

Al_2O_3

TiCN

Cemented carbide substrate

YBC152

Thick TiCN and thick Al_2O_3 coatings improve the impact toughness and abrasion resistance, which makes it suitable for finishing and semi-finishing of steel at high speed. Cutting speed can increase by more than 25%, while the tool life can increase by more than 30% at the same cutting speed.

YBC252

Comprising of thick TiCN and thick Al_2O_3 coatings, the grade has high capability against plastic deformation and good hardness of cutting edge. It is preferred grade for machining of steel from finishing to roughing. Under the same cutting conditions, the cutting speed can be increased by more than 25%, while the tool life can be 30% longer under the same cutting speed.

YBC352

Thickness TiCN and Al_2O_3 coating, with strongest toughness and plastic deformation resistance, the ideal grade for high efficient steel rough machining under the bad condition.

Test comparison of inserts abrasion

Workpiece material : 45#steel

Inserts: CNMG432-DM

Cutting parameters: $V_c=1300$ SFPM

$a_p=0.04$ (inch) $f_n=0.008$ (inch/r)

Grade from other company

YBC152

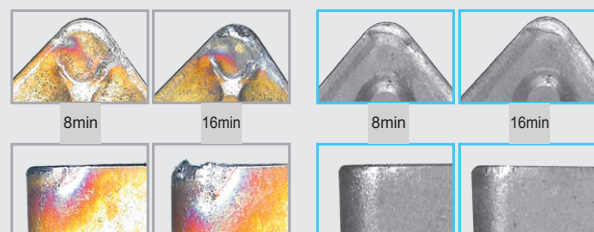

Coated Cemented Carbide CVD

BLACK DIAMOND INSERTS **YBD**

First choice for high-efficiency and highspeed machining of cast iron

- The combination of thick coating and substrate with good hardness and impact resistance gives the inserts excellent impact resistance and stability under high temperature, and improves wear resistance of inserts. Inserts also satisfy the requirements of high speed and high feed rate when machining cast iron.
- The appearance of shining full black is easily identified.

Significant results

- Working efficiency has been improved. Both the coating and the substrate are suitable for machining cast iron at high speed and high feed rate. Cutting speed can be increased by 30% to 40%.
- Cost is reduced as tool life is increased by 40%-50%.
- High machining stability.

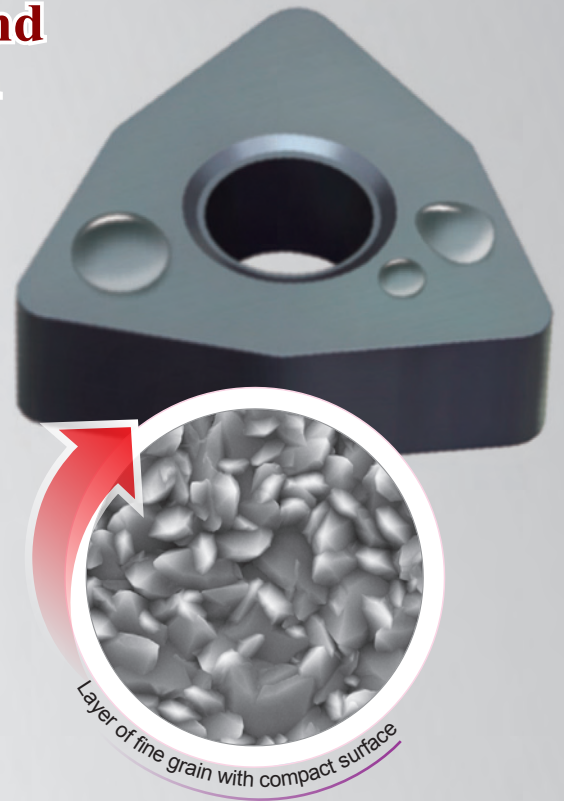

YBD052

CVD coated grade, which is characterized by super fine grain and smooth surface, is the combination of hard substrate and coating (extra thick Al_2O_3 + thick TiCN). The grade is optimized for best wear resistance when machining gray cast iron at high speed under dry condition.

YBD102

CVD coated grade, which is the combination of hard substrate and coating (thick Al_2O_3 + thick TiCN), shows excellent wear resistance and impact resistance when machining nodular cast iron at high speed.

YBD152

CVD coated grade, which is the combination of hard substrate and coating (medium thick Al_2O_3 + thick TiCN), has good flaking resistance. It is suitable for turning of cast iron at high speed, and light intermittent cutting can be supported even at moderate speed. It is also suitable for milling of cast iron.

YBD252

CVD coated grade, which is the combination of hard substrate and coating (medium thick Al_2O_3 + thick TiCN), achieves the balance between wear resistance and toughness. It is suitable for wet milling of cast iron, which requires toughness (such as nodular cast iron) at moderate or low speed. It is also suitable for intermittent turning.

YBC151

Substrate with special structure, in combination with Ti(CN), thick layer Al₂O₃, and TiN coating. High resistance to diffusion of rake face and resistance to plastic deformation it is good for finishing and semi-finishing (turning as well as boring) of stainless steel.

YBC251

Coated carbide grade with special strength and toughness, in an optimal combination with MT-Ti(CN), thick layer Al₂O₃, and TiN coating. Suitable grade for wide application. It is recommended for the finishing, semi-finishing and light roughing of steel, cast steel and stainless steel.

YBC351

Substrate with high strength and resistance against plastic deformation, in combination with MT-Ti(CN), thick layer Al₂O₃, TiN coating. It is suitable for light roughing and roughing steel, cast steel and stainless steel.

YBM151

Substrate with special matrix, in combination with Ti(CN), thick layer Al₂O₃, and TiN coating. With the resistance to rake face diffusion and plastic deformation, it is good for finishing and semi-finishing (turning as well as boring) of stainless steel.



YBM251

Substrate with good toughness and strength, in combination with Ti(CN), thin layer Al₂O₃, TiN coating, It is a premium grade for semi-finishing to light roughing (turning and boring) of stainless steel at continuous and intermittent machining conditions.

YBM253

Ideal grade for turning of stainless steel with high cutting depth and high feed rate under bad working condition.

- Ultra-fine grain coating technology provides better wear resistance and toughness;
- Improved remain internal stress design ensures good toughness and anti-cracking performance;
- Polishing treatment on coating surface makes it suitable for cutting adhesive materials.

Main grades and applications

YNG151

TiCN based cermets, of which the grains are refined with a special process with more even grain size. The combination of cemented carbide hard phase and the binder phase is even more strengthened, further improving the wear resistance and lifetime of the inserts. They are suitable for the finishing and super finishing of steel, stainless steel and cast iron.

YNG151C

TiCN based cermets+Nano PVD coating, of which the surface is specially pre-treated with an even and smooth surface. The friction coefficient of the workpiece in relation to the insert is reduced, causing good chip flow, increased wear resistance, and prolonged lifetime of insert. They are suitable for the finishing and fine finishing of steel materials, stainless steel and cast iron.

-LC *New-generation chipbreaker for AI machining*

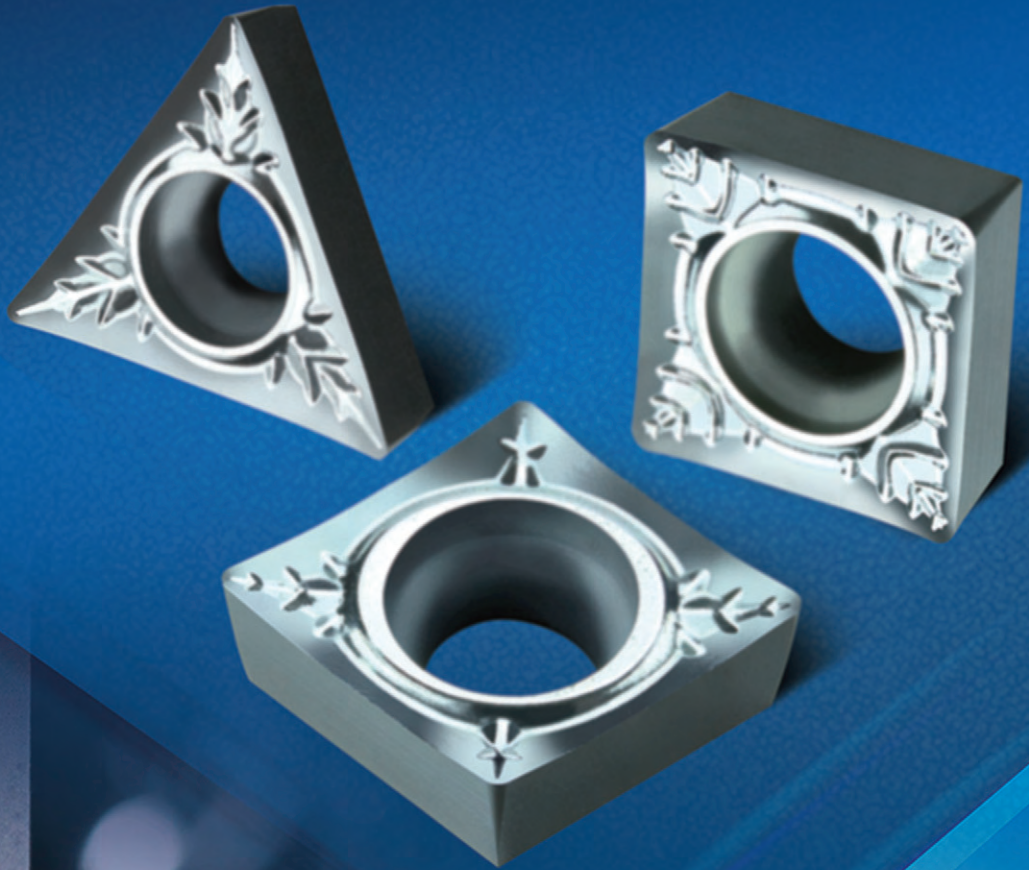

-LC New-generation chipbreaker for aluminum

- LC inserts are designed with a special chipbreaker. Large rake angle and clearance angle allow for sharper cutting edge, ensuring smoother cutting, while controlling chips.
- A polished rake face reduces friction and adhesion to cutting tool. Chips are allowed to flow freely across rake face and improve the quality of the workpiece finish.
- G-class precision tolerance of insert permits higher accuracy of surface finish and better repeatability when insert is indexed. Machining vibration is reduced also.

Angular cutting edge improves chip flow and control.

Cutting edge segues from nose to main edge without interruption.

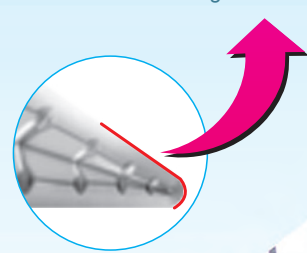
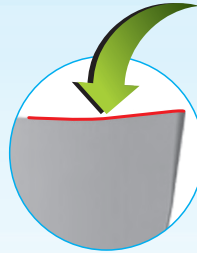

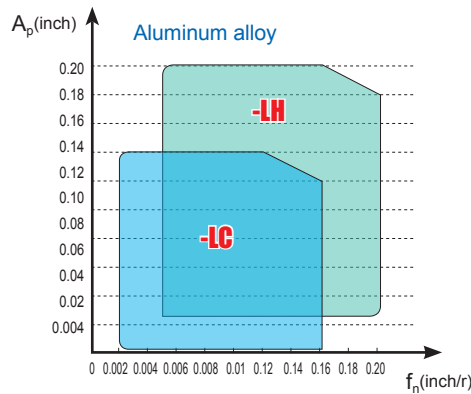
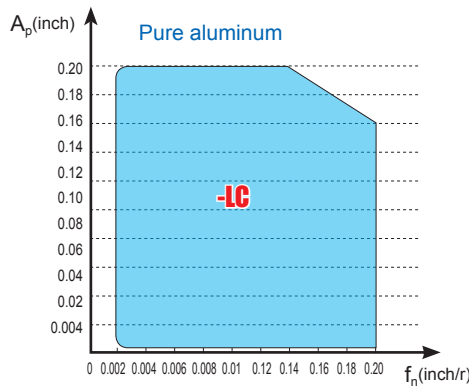

-LC and -LH chipbreaker characteristics and machining range

-LC chipbreaker can be used in machining of pure Al, while -LH chipbreaker can not.
-LC chipbreaker expand the chip breaking range of Al alloy machining.

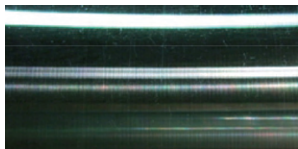
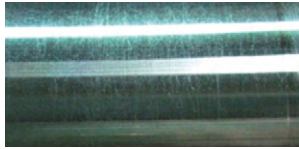

Workpiece material: Pure aluminum

Cutting parameters	V=1148SFPM Ap=0.008inch F=0.008inch/r	
Chips		
Surface quality		
	-LC chipbreaker	Competitor's tool
	<ul style="list-style-type: none"> -LH chipbreaker is more suitable for machining aluminum alloy with larger cutting depth and higher feed rate. -LC chipbreaker is more suitable for machining aluminum alloy with smaller cutting depth and lower feed rate. 	

S- Ni-based Superalloy Machining

Difficulties Overcame

Features of Ni-based superalloy machining

- High cutting resistance (containing a large amount of alloying elements, severe hardening, great plastic deformation ;
- High cutting temperature;
- Severe wear of inserts.

Chipbreaker for machining of Ni-based superalloy should have tough and sharp insert nose, smooth rake face and proper inclination angle.

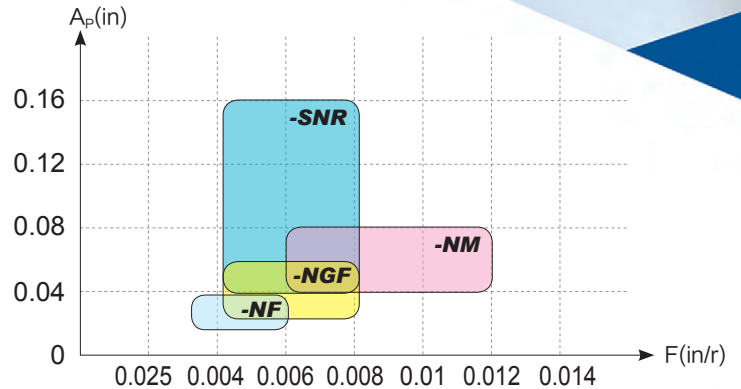

-NM for semi-finishing -SNR for high efficiency roughing
 -NF for finishing -NGF for general finishing

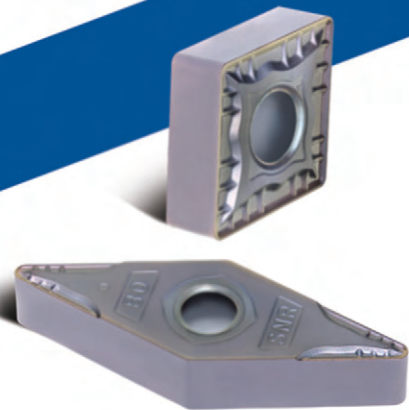

-SNR Chipbreaker for roughing with large depth of cut

- Positive rake angle design, sharp cutting edge, low cutting resistance, effectively reducing groove wear;
- Cutting edge with variable rake angles increase cutting edge strength at large depths of cut. Edge strength increases as the depth of cut increases;
- Large slot width combined with unique edge rib design not only provides excellent chip breaking performance but also can effectively improve edge strength.



-NGF Chipbreaker for General Finishing

- Proper inclination angle design, sharp cutting edge, small cutting resistance;
- E-level tolerance of insert, high clamping accuracy, proper chipbreaker width, good chip breaking performance, excellent surface quality;
- Special edge treatment, high wear resistance.

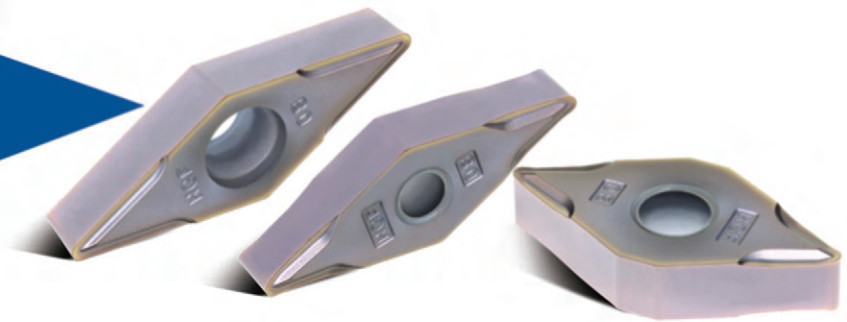

-NFINM Chipbreaker for General Finishing

- -NF chipbreaker has sharp cutting edge, while -NM chipbreaker high cutting edge strength.
- Smooth surface of chipbreaker ensures unobstructed chip flow.
- High wear resistance of cutting edge after special treatment.



D series chip-breaker

can be used for machining steel from finishing to roughing.

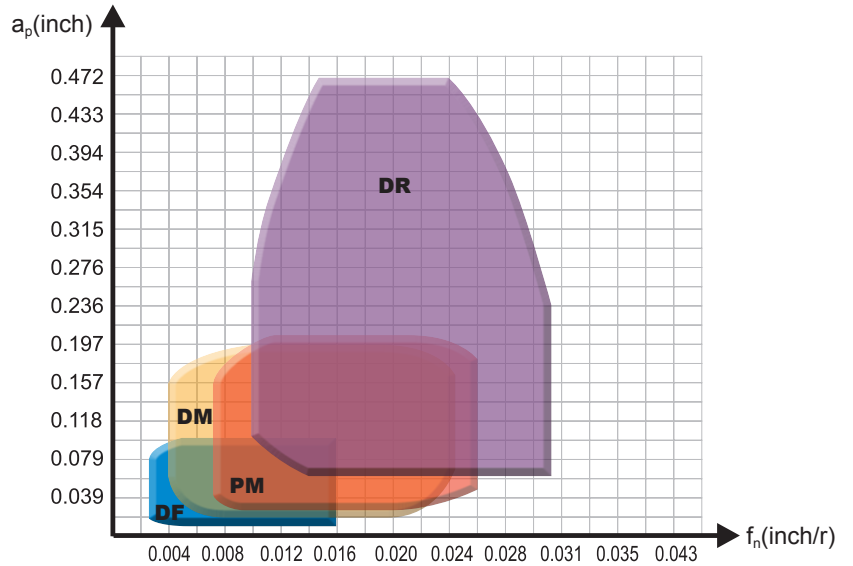
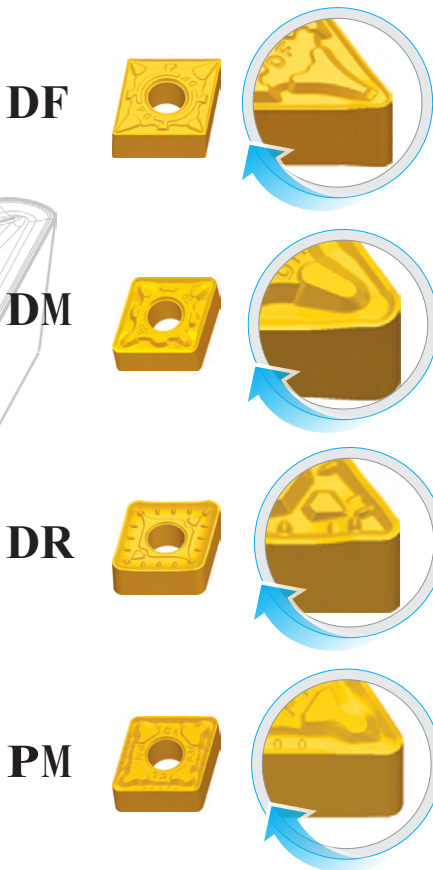

H series chip-breaker

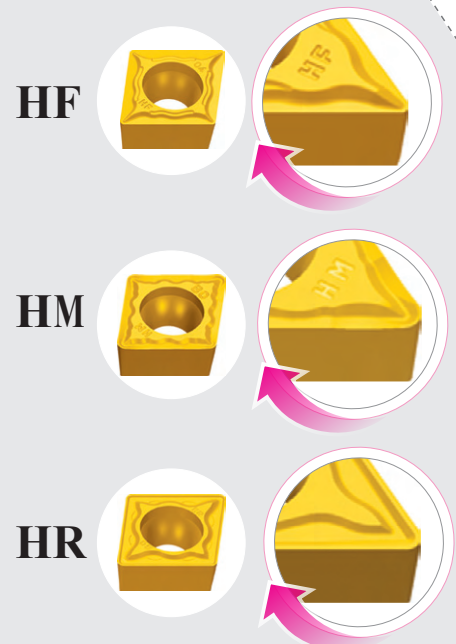
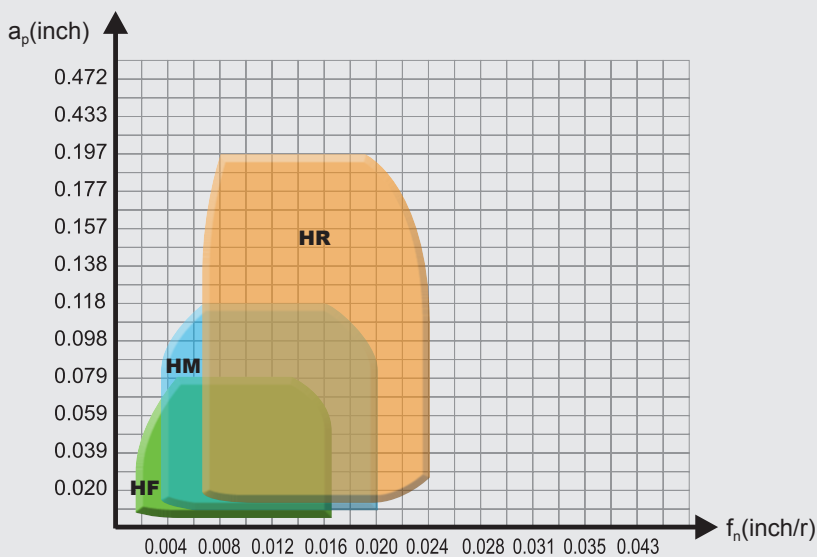

-WGM



*New product for
turning*

Wiper

-WGF

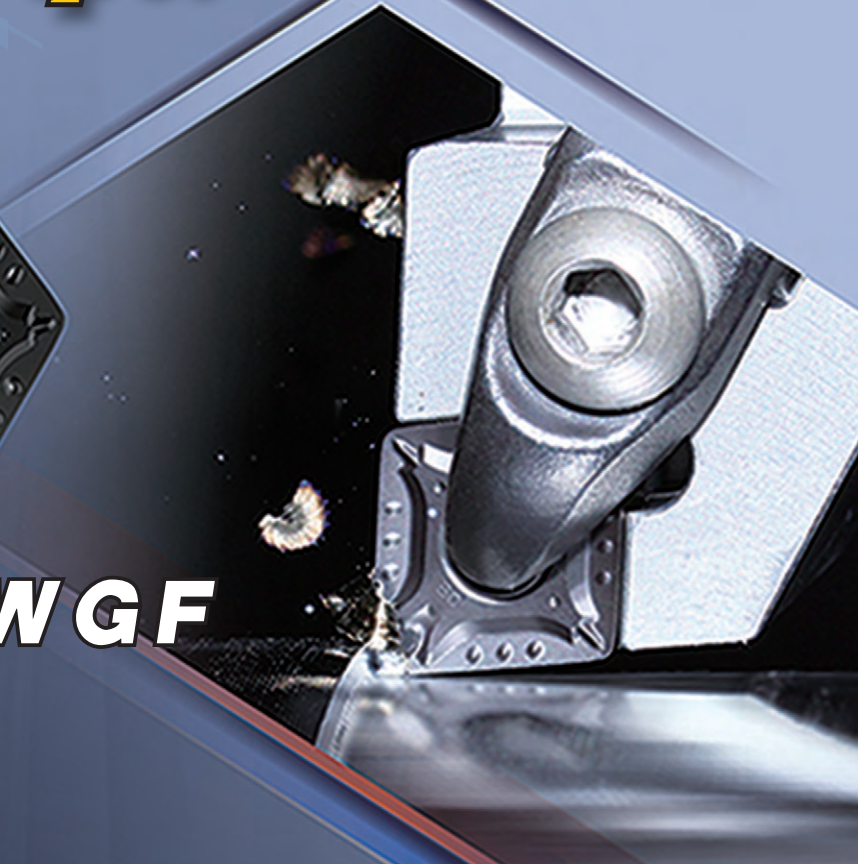

-WGF/WGM

chipbreaker series Turning inserts with wiper

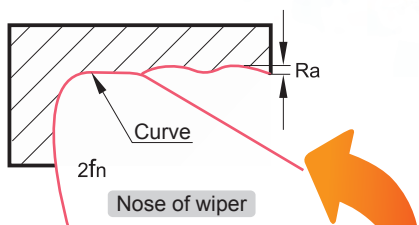

High efficiency

Roughness remains the same when feed rate is doubled.



Wiper is assembled by three curves to form a circular arc edge. The nose of wiper provides less profile height on the surface that is formed by the cutting edge, resulting in a smooth turning surface.

Inserts with wiper has high efficiency when used for finish and semi-finish turning. The surface quality remains the same even at double feed rate.

Wiper technique =
high machining efficiency + high surface quality

High quality

Roughness value is reduced to half when feed rate remains the same.

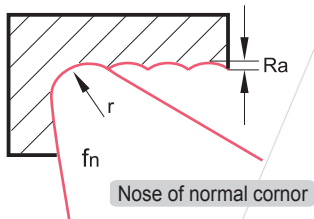
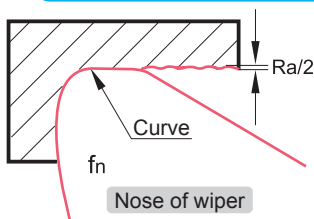

When used for finishing, it can improve roughness of workpiece surface and achieve turning instead of grinding.

When used for semi-finishing, efficiency could be improved by doubling the feed rate, the roughness of workpiece surface remaining the same.

Guide to use

● Select reasonable approach angle of the tools

Minor angle being close to 0 degree is the reason that inserts with wiper can reduce roughness of the surface, which is determined by the shape of insert and approach angle of the tool holder. Therefore, acceptable roughness of surface is the result of reasonable approach (minor) angle. The finishing function of wiper would be reduced or invalid if unreasonable approach (minor) angle is chosen. For example, the approach angle should be 95° for CNMG / WNMG inserts, while 93° is the best for DNMX / TNMX inserts.

● Be careful with DNMX / TNMX inserts

DNMX / TNMX inserts with wiper don't have wide application. It cannot achieve a wiper result when minor angle is not 0 degree, like chamfer and profile surface, and will even cause over-cutting or no-cutting on workpiece, affecting the shape and size precision of workpiece. Please contact technical service regarding these problems.



-SF

chipbreaker for finishing

- Unique nose design and sharp cutting edge lead to small cutting resistance and effectively reduce vibration of the tool holder.
- With high re-positioning precision, the insert is compatible with specially developed cemented carbide tool holders, which can increase the capability of vibration resistance and improve machining quality.
- Special treatment on insert's surface can reduce the possibility of chips adhering to the rake face of insert. Good performance of chip breaking and chip flowing ensures improved surface quality of workpiece.
- By adopting excellent grade, it is suitable for extra finishing of various materials.

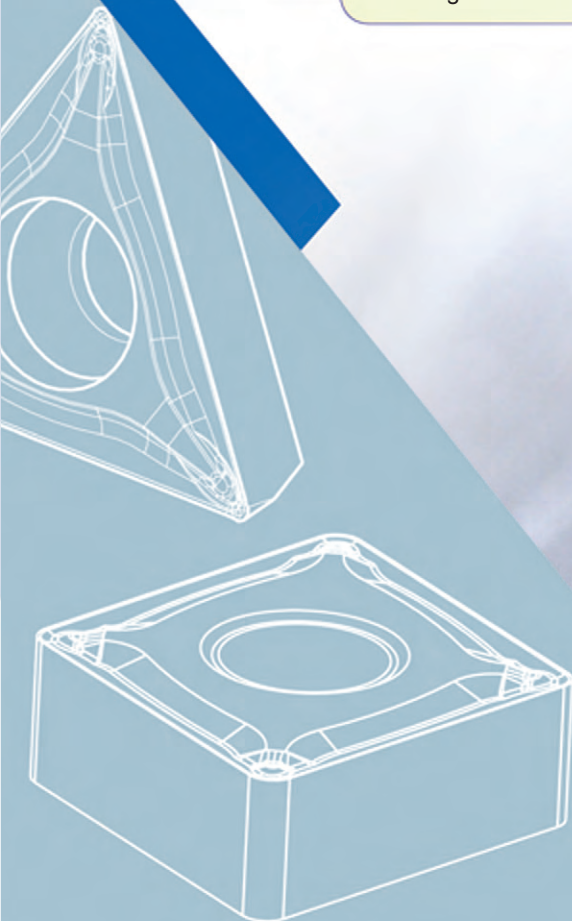
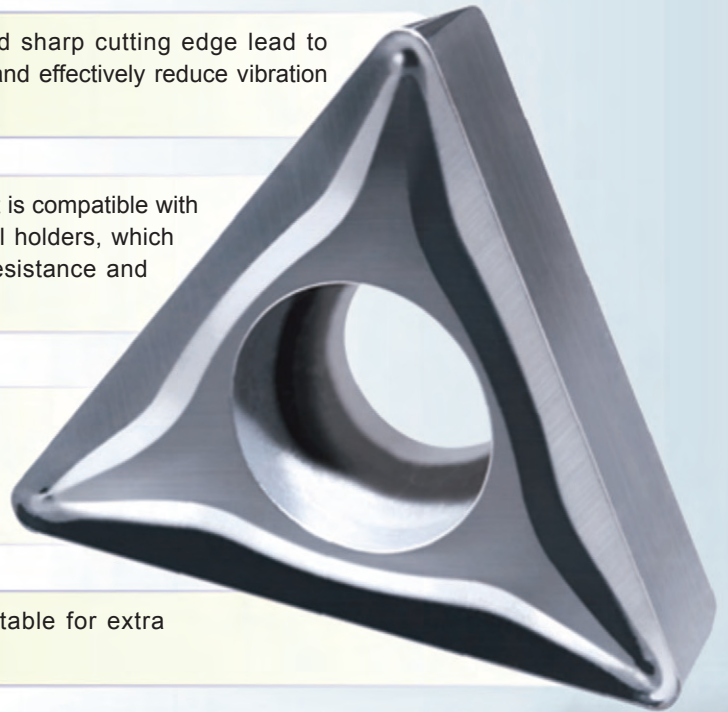

Insert shape

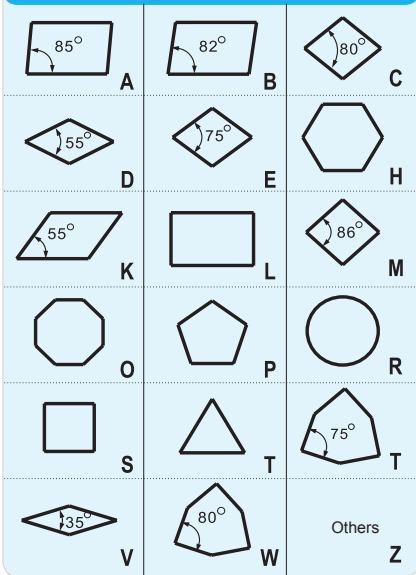

Major cutting edge Clearance angle

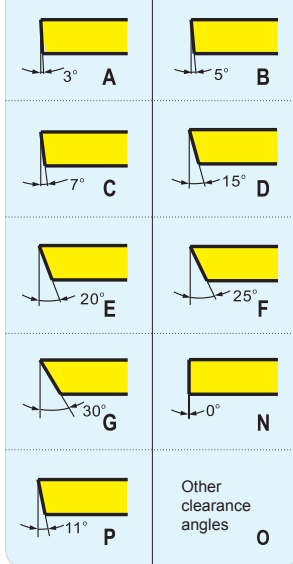

Chip-breaker and/or fixing type

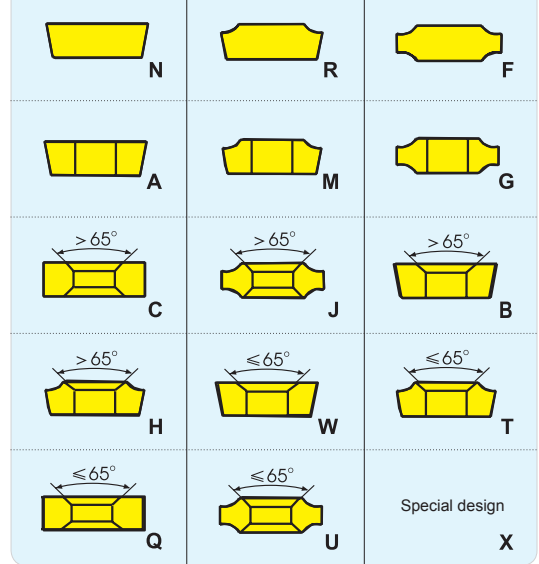

T N M G

Tolerances, inch

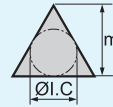
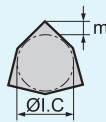

Letter Symbol	Tolerances in inches			Inscribed circle diameter	Tolerances for M		Tolerances for d																			
	m	s	d		Class M	Class U	Class M.J.K.L	Class U																		
A	±0.0002	±0.001	±0.0010	0.250	±0.003	±0.005	±0.002	±0.003																		
F	±0.0002	±0.001	±0.0005	0.375	±0.003	±0.005	±0.002	±0.003																		
C	±0.0005	±0.001	±0.0010	0.500	±0.005	±0.008	±0.003	±0.005																		
H	±0.0005	±0.001	±0.0005	0.625	±0.006	±0.011	±0.004	±0.007																		
E	±0.0010	±0.001	±0.0010	0.750	±0.006	±0.011	±0.004	±0.007																		
G	±0.0010	±0.005	±0.0010	1.000	±0.007	±0.015	±0.005	±0.010																		
J	±0.0002	±0.01	±0.002	Insert shape D <table border="1"> <thead> <tr> <th>Inscribed circle diameter</th> <th>Tolerances for M</th> <th>Tolerances for M</th> </tr> </thead> <tbody> <tr> <td>±0.250</td> <td>±0.004</td> <td>±0.002</td> </tr> <tr> <td>±0.375</td> <td>±0.004</td> <td>±0.002</td> </tr> <tr> <td>±0.500</td> <td>±0.006</td> <td>±0.003</td> </tr> <tr> <td>±0.625</td> <td>±0.007</td> <td>±0.004</td> </tr> <tr> <td>±0.750</td> <td>±0.007</td> <td>±0.004</td> </tr> </tbody> </table>					Inscribed circle diameter	Tolerances for M	Tolerances for M	±0.250	±0.004	±0.002	±0.375	±0.004	±0.002	±0.500	±0.006	±0.003	±0.625	±0.007	±0.004	±0.750	±0.007	±0.004
Inscribed circle diameter	Tolerances for M	Tolerances for M																								
±0.250	±0.004	±0.002																								
±0.375	±0.004	±0.002																								
±0.500	±0.006	±0.003																								
±0.625	±0.007	±0.004																								
±0.750	±0.007	±0.004																								
K	±0.0005	±0.01	±0.02	Insert shape D <table border="1"> <thead> <tr> <th>Inscribed circle diameter</th> <th>Tolerances for M</th> <th>Tolerances for M</th> </tr> </thead> <tbody> <tr> <td>±0.250</td> <td>±0.006</td> <td>±0.002</td> </tr> <tr> <td>±0.375</td> <td>±0.006</td> <td>±0.002</td> </tr> <tr> <td>±0.500</td> <td>±0.008</td> <td>±0.003</td> </tr> <tr> <td>±0.625</td> <td>±0.011</td> <td>±0.004</td> </tr> <tr> <td>±0.750</td> <td>±0.011</td> <td>±0.004</td> </tr> </tbody> </table>					Inscribed circle diameter	Tolerances for M	Tolerances for M	±0.250	±0.006	±0.002	±0.375	±0.006	±0.002	±0.500	±0.008	±0.003	±0.625	±0.011	±0.004	±0.750	±0.011	±0.004
Inscribed circle diameter	Tolerances for M	Tolerances for M																								
±0.250	±0.006	±0.002																								
±0.375	±0.006	±0.002																								
±0.500	±0.008	±0.003																								
±0.625	±0.011	±0.004																								
±0.750	±0.011	±0.004																								
L	±0.0010	±0.001	±0.002	Insert shape D <table border="1"> <thead> <tr> <th>Inscribed circle diameter</th> <th>Tolerances for M</th> <th>Tolerances for M</th> </tr> </thead> <tbody> <tr> <td>±0.250</td> <td>±0.006</td> <td>±0.002</td> </tr> <tr> <td>±0.375</td> <td>±0.006</td> <td>±0.002</td> </tr> <tr> <td>±0.500</td> <td>±0.008</td> <td>±0.003</td> </tr> <tr> <td>±0.625</td> <td>±0.011</td> <td>±0.004</td> </tr> <tr> <td>±0.750</td> <td>±0.011</td> <td>±0.004</td> </tr> </tbody> </table>					Inscribed circle diameter	Tolerances for M	Tolerances for M	±0.250	±0.006	±0.002	±0.375	±0.006	±0.002	±0.500	±0.008	±0.003	±0.625	±0.011	±0.004	±0.750	±0.011	±0.004
Inscribed circle diameter	Tolerances for M	Tolerances for M																								
±0.250	±0.006	±0.002																								
±0.375	±0.006	±0.002																								
±0.500	±0.008	±0.003																								
±0.625	±0.011	±0.004																								
±0.750	±0.011	±0.004																								
M	±0.003	±0.005	±0.002	Insert shape D <table border="1"> <thead> <tr> <th>Inscribed circle diameter</th> <th>Tolerances for M</th> <th>Tolerances for M</th> </tr> </thead> <tbody> <tr> <td>±0.250</td> <td>±0.006</td> <td>±0.002</td> </tr> <tr> <td>±0.375</td> <td>±0.006</td> <td>±0.002</td> </tr> <tr> <td>±0.500</td> <td>±0.008</td> <td>±0.003</td> </tr> <tr> <td>±0.625</td> <td>±0.011</td> <td>±0.004</td> </tr> <tr> <td>±0.750</td> <td>±0.011</td> <td>±0.004</td> </tr> </tbody> </table>					Inscribed circle diameter	Tolerances for M	Tolerances for M	±0.250	±0.006	±0.002	±0.375	±0.006	±0.002	±0.500	±0.008	±0.003	±0.625	±0.011	±0.004	±0.750	±0.011	±0.004
Inscribed circle diameter	Tolerances for M	Tolerances for M																								
±0.250	±0.006	±0.002																								
±0.375	±0.006	±0.002																								
±0.500	±0.008	±0.003																								
±0.625	±0.011	±0.004																								
±0.750	±0.011	±0.004																								
N	±0.003	±0.001	±0.002	Insert shape D <table border="1"> <thead> <tr> <th>Inscribed circle diameter</th> <th>Tolerances for M</th> <th>Tolerances for M</th> </tr> </thead> <tbody> <tr> <td>±0.250</td> <td>±0.006</td> <td>±0.002</td> </tr> <tr> <td>±0.375</td> <td>±0.006</td> <td>±0.002</td> </tr> <tr> <td>±0.500</td> <td>±0.008</td> <td>±0.003</td> </tr> <tr> <td>±0.625</td> <td>±0.011</td> <td>±0.004</td> </tr> <tr> <td>±0.750</td> <td>±0.011</td> <td>±0.004</td> </tr> </tbody> </table>					Inscribed circle diameter	Tolerances for M	Tolerances for M	±0.250	±0.006	±0.002	±0.375	±0.006	±0.002	±0.500	±0.008	±0.003	±0.625	±0.011	±0.004	±0.750	±0.011	±0.004
Inscribed circle diameter	Tolerances for M	Tolerances for M																								
±0.250	±0.006	±0.002																								
±0.375	±0.006	±0.002																								
±0.500	±0.008	±0.003																								
±0.625	±0.011	±0.004																								
±0.750	±0.011	±0.004																								
U	±0.005	±0.005	±0.003	Insert shape D <table border="1"> <thead> <tr> <th>Inscribed circle diameter</th> <th>Tolerances for M</th> <th>Tolerances for M</th> </tr> </thead> <tbody> <tr> <td>±0.250</td> <td>±0.006</td> <td>±0.002</td> </tr> <tr> <td>±0.375</td> <td>±0.006</td> <td>±0.002</td> </tr> <tr> <td>±0.500</td> <td>±0.008</td> <td>±0.003</td> </tr> <tr> <td>±0.625</td> <td>±0.011</td> <td>±0.004</td> </tr> <tr> <td>±0.750</td> <td>±0.011</td> <td>±0.004</td> </tr> </tbody> </table>					Inscribed circle diameter	Tolerances for M	Tolerances for M	±0.250	±0.006	±0.002	±0.375	±0.006	±0.002	±0.500	±0.008	±0.003	±0.625	±0.011	±0.004	±0.750	±0.011	±0.004
Inscribed circle diameter	Tolerances for M	Tolerances for M																								
±0.250	±0.006	±0.002																								
±0.375	±0.006	±0.002																								
±0.500	±0.008	±0.003																								
±0.625	±0.011	±0.004																								
±0.750	±0.011	±0.004																								
	±0.015		±0.010	Insert shape D <table border="1"> <thead> <tr> <th>Inscribed circle diameter</th> <th>Tolerances for M</th> <th>Tolerances for M</th> </tr> </thead> <tbody> <tr> <td>±0.250</td> <td>±0.006</td> <td>±0.002</td> </tr> <tr> <td>±0.375</td> <td>±0.006</td> <td>±0.002</td> </tr> <tr> <td>±0.500</td> <td>±0.008</td> <td>±0.003</td> </tr> <tr> <td>±0.625</td> <td>±0.011</td> <td>±0.004</td> </tr> <tr> <td>±0.750</td> <td>±0.011</td> <td>±0.004</td> </tr> </tbody> </table>					Inscribed circle diameter	Tolerances for M	Tolerances for M	±0.250	±0.006	±0.002	±0.375	±0.006	±0.002	±0.500	±0.008	±0.003	±0.625	±0.011	±0.004	±0.750	±0.011	±0.004
Inscribed circle diameter	Tolerances for M	Tolerances for M																								
±0.250	±0.006	±0.002																								
±0.375	±0.006	±0.002																								
±0.500	±0.008	±0.003																								
±0.625	±0.011	±0.004																								
±0.750	±0.011	±0.004																								

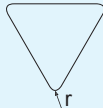

Inscribed circle diameter						
Code(inch)	2	3	4	5	6	8
Inscribed circle diameter(inch)	0.250	0.375	0.500	0.625	0.750	1.000

Nose radius								
	Code(inch)	0	1	2	3	4	5	6
	Nose acircle (inch)		0.008	0.016	0.031	0.047	0.063	0.079

4 3 2 - DM

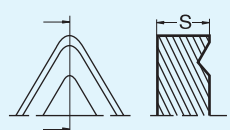
Insert thickness						
	Code(inch)	2	3	4	5	6
	Inscribed radius diameter(inch)		0.125	0.187	0.250	0.313

Chip-breakers code

Position 10 indicates the cutting properties & chip-breakers of inserts

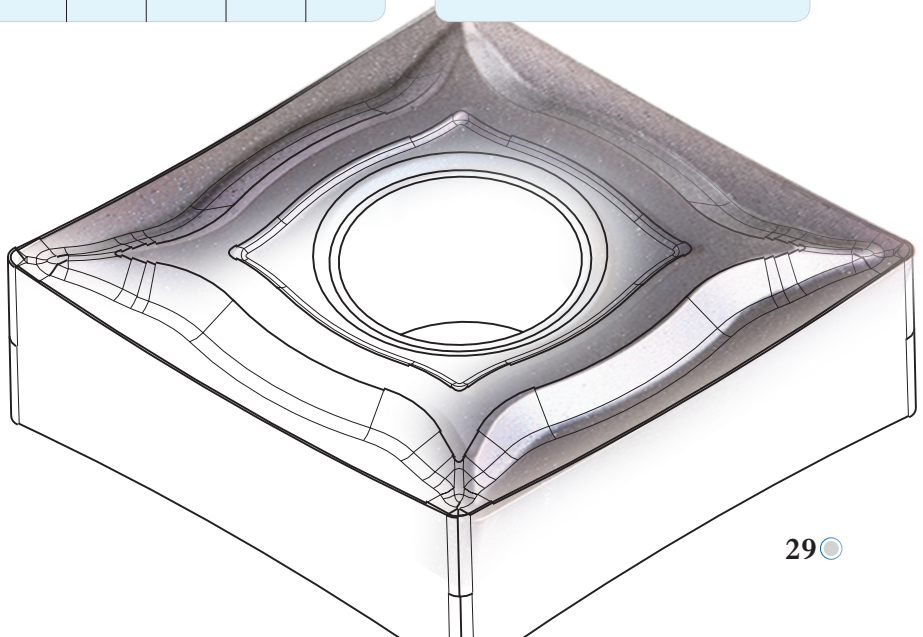



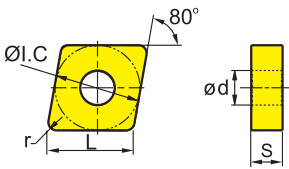

CN (Negative inserts)



😊 Good working conditions 😐 General working conditions 😞 Adverse working conditions

Workpiece material	P Steel	M Stainless steel	K Cast iron	N Ferrite materials	S Heat-resistant steel
P Steel	😊😊😊😊😊😊😊😊😊😊	😊😊😊😊😊😊😊😊😊😊	😊😊😊😊😊😊😊😊😊😊	😊😊😊😊😊😊😊😊😊😊	😊😊😊😊😊😊😊😊😊😊
M Stainless steel	😊😊😊😊😊😊😊😊😊😊	😊😊😊😊😊😊😊😊😊😊	😊😊😊😊😊😊😊😊😊😊	😊😊😊😊😊😊😊😊😊😊	😊😊😊😊😊😊😊😊😊😊
K Cast iron	😊😊😊😊😊😊😊😊😊😊	😊😊😊😊😊😊😊😊😊😊	😊😊😊😊😊😊😊😊😊😊	😊😊😊😊😊😊😊😊😊😊	😊😊😊😊😊😊😊😊😊😊
N Ferrite materials	😊😊😊😊😊😊😊😊😊😊	😊😊😊😊😊😊😊😊😊😊	😊😊😊😊😊😊😊😊😊😊	😊😊😊😊😊😊😊😊😊😊	😊😊😊😊😊😊😊😊😊😊
S Heat-resistant steel	😊😊😊😊😊😊😊😊😊😊	😊😊😊😊😊😊😊😊😊😊	😊😊😊😊😊😊😊😊😊😊	😊😊😊😊😊😊😊😊😊😊	😊😊😊😊😊😊😊😊😊😊

Inserts shape	Type	Dimensions (inch)						Coated cemented carbide														Cemented carbide																	
		L	ØI.C	S	ød	r	YBC151	YBC152	YBC251	YBC252	YBC351	YBC352	YBG102	YBG105	YBG202	YBG205	YBG212	YBM151	YBM251	YBM253	YBD052		YBD102	YBD151	YBD152	YBD252	Cermet Coated cermet	YC10	YC40	YD051	YD101	YD201							
 Finishing	CNMG321-DF	0.382	0.375	0.125	0.150	0.016		○							○																								
	CNMG322-DF	0.382	0.375	0.125	0.150	0.031		○	○	○																													
	CNMG431-DF	0.508	0.500	0.187	0.203	0.016		●	●	●						○																							
	CNMG432-DF	0.508	0.500	0.187	0.203	0.031		●	●	●	○					○																							
	CNMG433-DF	0.508	0.500	0.187	0.203	0.047		●	○	○																													
 Finishing	CNMG431-WGF	0.508	0.500	0.187	0.203	0.016		●																															
	CNMG432-WGF	0.508	0.500	0.187	0.203	0.031		●																															
 Finishing	CNMG321-SF	0.382	0.375	0.125	0.150	0.016																																	
	CNMG322-SF	0.382	0.375	0.125	0.150	0.031																																	
	CNMG431-SF	0.508	0.500	0.187	0.203	0.016																																	
	CNMG432-SF	0.508	0.500	0.187	0.203	0.031																																	
	CNMG433-SF	0.508	0.500	0.187	0.203	0.047																																	
 Finishing	CNMG321-EF	0.382	0.375	0.125	0.150	0.016																																	
	CNMG322-EF	0.382	0.375	0.125	0.150	0.031																																	
	CNMG431-EF	0.508	0.500	0.187	0.203	0.016																																	
	CNMG432-EF	0.508	0.500	0.187	0.203	0.031																																	
	CNMG433-EF	0.508	0.500	0.187	0.203	0.047																																	
 Finishing	CNEG321-NF	0.382	0.375	0.125	0.150	0.016																																	
	CNEG322-NF	0.382	0.375	0.125	0.150	0.031																																	
	CNEG431-NF	0.508	0.500	0.187	0.203	0.016																																	
	CNEG432-NF	0.508	0.500	0.187	0.203	0.031																																	
	CNEG433-NF	0.508	0.500	0.187	0.203	0.047																																	

● Always stock available ○ Produce according to order

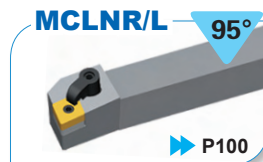
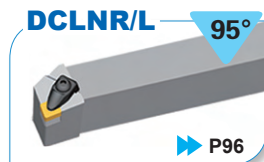

Applicable tool

DN (Negative inserts)

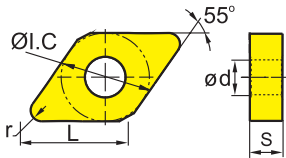

😊 Good working conditions 😐 General working conditions ☹️ Adverse working conditions

Workpiece material	P Steel	M Stainless steel	K Cast iron	N Ferrite materials	S Heat-resistant steel
P Steel	😊😊😊😊😊😊😊😊😊😊	😊😊😊😊😊😊😊😊😊😊	😊😊😊😊😊😊😊😊😊😊	😊😊😊😊😊😊😊😊😊😊	😊😊😊😊😊😊😊😊😊😊
M Stainless steel	😊😊😊😊😊😊😊😊😊😊	😊😊😊😊😊😊😊😊😊😊	😊😊😊😊😊😊😊😊😊😊	😊😊😊😊😊😊😊😊😊😊	😊😊😊😊😊😊😊😊😊😊
K Cast iron	😊😊😊😊😊😊😊😊😊😊	😊😊😊😊😊😊😊😊😊😊	😊😊😊😊😊😊😊😊😊😊	😊😊😊😊😊😊😊😊😊😊	😊😊😊😊😊😊😊😊😊😊
N Ferrite materials	😊😊😊😊😊😊😊😊😊😊	😊😊😊😊😊😊😊😊😊😊	😊😊😊😊😊😊😊😊😊😊	😊😊😊😊😊😊😊😊😊😊	😊😊😊😊😊😊😊😊😊😊
S Heat-resistant steel	😊😊😊😊😊😊😊😊😊😊	😊😊😊😊😊😊😊😊😊😊	😊😊😊😊😊😊😊😊😊😊	😊😊😊😊😊😊😊😊😊😊	😊😊😊😊😊😊😊😊😊😊

Inserts shape	Type	Dimensions (inch)					Coated cemented carbide												Cermet Coated cermet	Cemented carbide															
		L	ØI.C	S	ød	r	YBC151	YBC152	YBC251	YBC252	YBC351	YBC352	YBG102	YBG105	YBG202	YBG205	YBG212	YBM151		YBM251	YBM253	YBD052	YBD102	YBD151	YBD152	YBD252	YNG151	YNG151C	YC10	YC40	YD051	YD101	YD201		
ER Roughing	DNMM442-ER	0.610	0.500	0.250	0.203	0.031														●															
	DNMM443-ER	0.610	0.500	0.250	0.203	0.047														●															
SNR Roughing	DNMG442-SNR	0.610	0.500	0.250	0.203	0.031						○	●			○																			
	DNMG443-SNR	0.610	0.500	0.250	0.203	0.047						○	●			○																			
Conventional chipbreaker	DNMG441	0.610	0.500	0.250	0.203	0.016																													
	DNMG442	0.610	0.500	0.250	0.203	0.031																													
	DNMG443	0.610	0.500	0.250	0.203	0.047																													
	DNMG444	0.610	0.500	0.250	0.203	0.063																													
	DNMG542	0.760	0.625	0.250	0.203	0.031																													
	DNMG543	0.760	0.625	0.250	0.203	0.047																													
Without chipbreaker (flat top)	DNMA431	0.610	0.500	0.187	0.203	0.016																													
	DNMA432	0.610	0.500	0.187	0.203	0.031																													
	DNMA441	0.610	0.500	0.250	0.203	0.016																													
	DNMA442	0.610	0.500	0.250	0.203	0.031																													
	DNMA443	0.610	0.500	0.250	0.203	0.047																													
	DNMA444	0.610	0.500	0.250	0.203	0.063																													

● Always stock available ○ Produce according to order

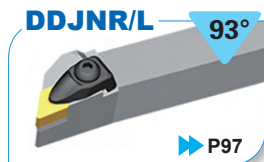
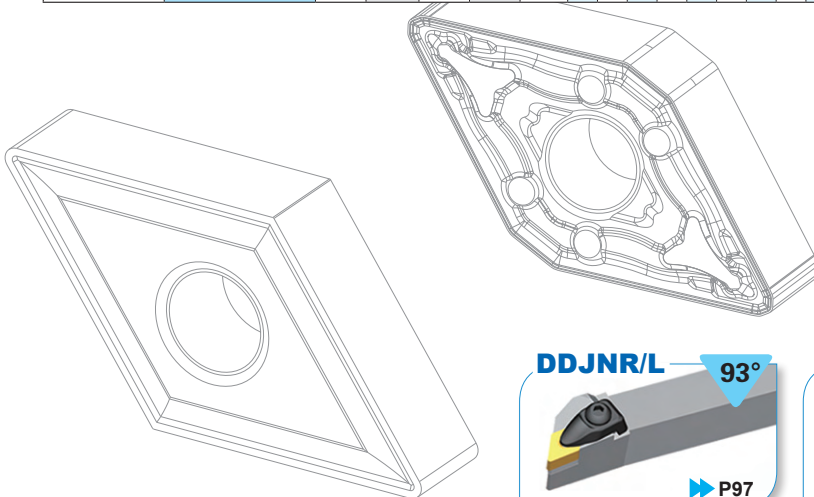

Applicable tool

TN

(Negative inserts)

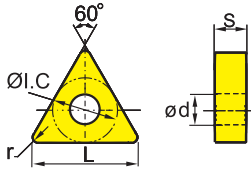

😊 Good working conditions 😐 General working conditions ☹️ Adverse working conditions

Workpiece material	Steel	Stainless steel	Cast iron	Ferrite materials	Heat-resistant steel
P	😊😊😊😊😊😊😊😊😊😊	😊😊😊😊😊😊😊😊😊😊	😊😊😊😊😊😊😊😊😊😊	😊😊😊😊😊😊😊😊😊😊	😊😊😊😊😊😊😊😊😊😊
M	😊😊😊😊😊😊😊😊😊😊	😊😊😊😊😊😊😊😊😊😊	😊😊😊😊😊😊😊😊😊😊	😊😊😊😊😊😊😊😊😊😊	😊😊😊😊😊😊😊😊😊😊
K	😊😊😊😊😊😊😊😊😊😊	😊😊😊😊😊😊😊😊😊😊	😊😊😊😊😊😊😊😊😊😊	😊😊😊😊😊😊😊😊😊😊	😊😊😊😊😊😊😊😊😊😊
N	😊😊😊😊😊😊😊😊😊😊	😊😊😊😊😊😊😊😊😊😊	😊😊😊😊😊😊😊😊😊😊	😊😊😊😊😊😊😊😊😊😊	😊😊😊😊😊😊😊😊😊😊
S	😊😊😊😊😊😊😊😊😊😊	😊😊😊😊😊😊😊😊😊😊	😊😊😊😊😊😊😊😊😊😊	😊😊😊😊😊😊😊😊😊😊	😊😊😊😊😊😊😊😊😊😊

Inserts shape	Type	Dimensions (inch)					Coated cemented carbide													Cermet	Coated cermet	Cemented carbide																			
		L	ØI.C	S	ød	r	YBC151	YBC152	YBC251	YBC252	YBC351	YBC352	YBG102	YBG105	YBG202	YBG205	YBG212	YBM151	YBM251			YBM253	YBD052	YBD102	YBD151	YBD152	YBD252	YNG151	YNG151C	YC10	YC40	YD051	YD101	YD201							
WGM 	TNMX332-WGM	0.650	0.375	0.187	0.150	0.031				●						●																									
	TNMX333-WGM	0.650	0.375	0.187	0.150	0.047				●						●																									
PM 	TNMG221-PM	0.433	0.250	0.125	0.089	0.016		●	●	○																															
	TNMG222-PM	0.433	0.250	0.125	0.089	0.031		●	○	○																															
	TNMG331-PM	0.650	0.375	0.187	0.150	0.016		●	●	●																															
	TNMG332-PM	0.650	0.375	0.187	0.150	0.031		●	●	●	●																														
	TNMG333-PM	0.650	0.375	0.187	0.150	0.047		●	●	○	○																														
	TNMG432-PM	0.866	0.500	0.187	0.203	0.031		●	●	○	●																														
	TNMG433-PM	0.866	0.500	0.187	0.203	0.047		●	●	●	○	○																													
	TNMG434-PM	0.866	0.500	0.187	0.203	0.063				○	○																														
DM 	TNMG222-DM	0.433	0.250	0.125	0.089	0.031		○		○																															
	TNMG331-DM	0.650	0.375	0.187	0.150	0.016		●	●	●	○					○																									
	TNMG332-DM	0.650	0.375	0.187	0.150	0.031		●	●	●	●					●																									
	TNMG333-DM	0.650	0.375	0.187	0.150	0.047		○	○	●	○																														
	TNMG431-DM	0.866	0.500	0.187	0.203	0.016		●	●	●	○																														
	TNMG432-DM	0.866	0.500	0.187	0.203	0.031		●	●	●	●																														
	TNMG433-DM	0.866	0.500	0.187	0.203	0.047		○	○	○	○																														
	TNMG434-DM	0.866	0.500	0.187	0.203	0.063		○	○	○	○																														

● Always stock available ○ Produce according to order

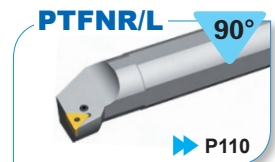
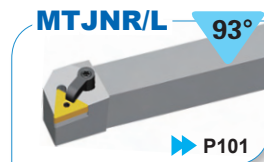
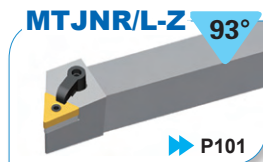

Applicable tool

External turning toolholders code key

A

Insert mounting method	Insert shape		Insert clearance angle	Cutting direction
D-Double clamping	80°	55°	5° B	L-Left hand
P-Lever Clamp	55°	R	7° C	R-Right hand
M-multi Clamp	90°	60°	15° D	N-neutral
S-Screw Clamp	35°	80°	20° E	
C-Top Clamp			0° N	
			11° P	

M C L N R

Tool holder style							
A	B	C	D	E	F	G	H
90°	75°	90°	45°	60°	90°	90°	107°30'
J	K	L	M	N	O	P	Q
93°	75°	95°	50°	63°	117°30'	62°30'	107°30'
R	S	T	U	V	W	X	
75°	45°	60°	93°	72°30'	60°	120°	

Tool holder height and width

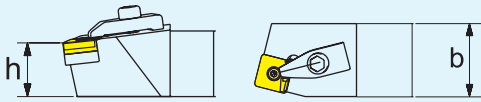

NO.	b	h	NO.	b	h
05	0.3125	0.3125	24	1.50	1.50
06	0.375	0.375	32	2.00	2.00
08	0.50	0.50	64	0.75	1.00
10	0.625	0.625	66	0.75	1.50
12	0.75	0.75	85	1.00	1.25
16	1.00	1.00	86	1.00	1.50
20	1.25	1.25	91	1.25	1.50

Insert I.C size

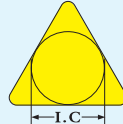

Number of 1/8" of inscribed circle

- 2 = 0.250"
- 3 = 0.375"
- 4 = 0.500"
- 5 = 0.625"
- 6 = 0.750"
- 7 = 0.875"
- 8 = 1.000"

Tool Length

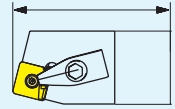

- J = 3-1/2"
- A = 4"
- B = 4-1/2"
- C = 5"
- D = 6"
- E = 7"
- F = 8"

A

16 - 4 D









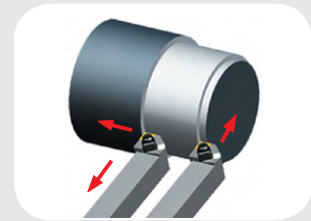
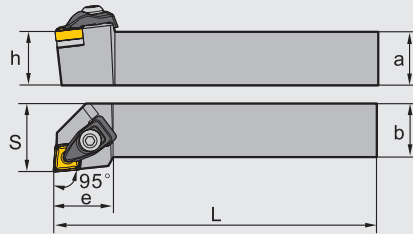

Applicable toolholders to CN□□□

D-type clamping

DCLNR/L

95°







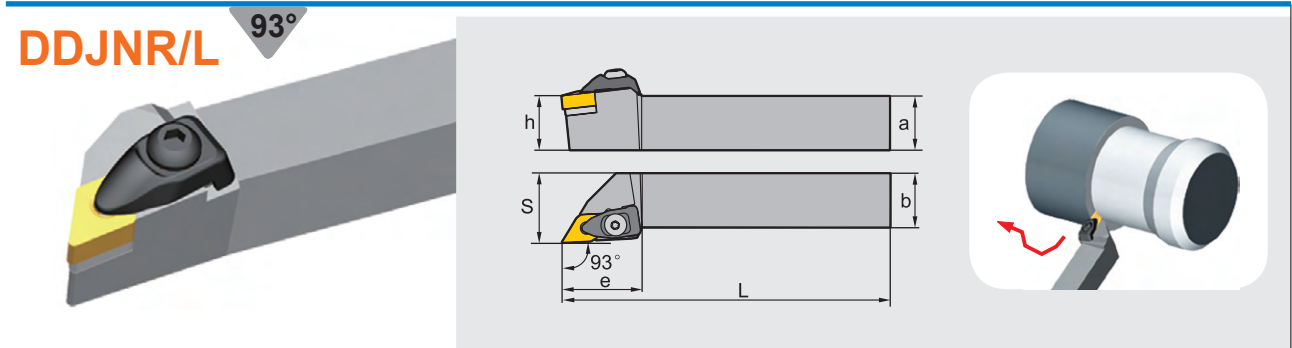

Type	Dimension(inch)						Applicable inserts  P30-34/78	Clamping screw 	Shim 	Wrench 	Clamp 	Shim screw 	Spring 
	a	b	L	h	s	e							
DCLNR/L 10-3A	0.625	0.625	4.00	0.625	0.75	0.945							
DCLNR/L 12-3C	0.75	0.75	5.00	0.75	1.00	0.945	CN□□32□□	CM5×22C	C09BM	WH30L	C1RA	SM5×8.65XA1	SPR6
DCLNR/L 16-3D	1.00	1.00	6.00	1.00	1.25	0.945							
DCLNR/L 12-4C	0.75	0.75	5.00	0.75	1.00	1.102							
DCLNR/L 16-4D	1.00	1.00	6.00	1.00	1.25	1.102	CN□□43□□	CM6×25C	C12BM	WH40L	C2RA	SM6×10XA1	SPR4
DCLNR/L 85-4E	1.25	1.00	7.00	1.25	1.25	1.102							









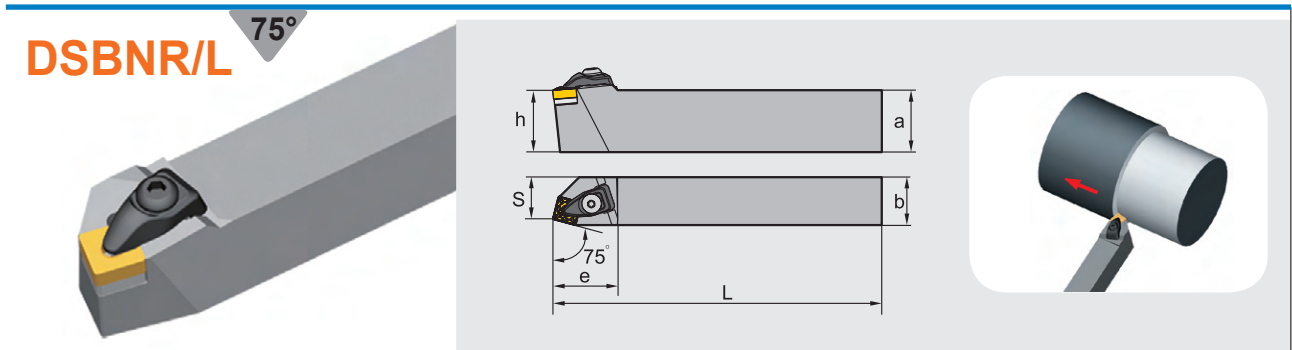

Applicable toolholders to **DN** □ □ **D-type clamping**



Type	Dimension(inch)						Applicable inserts  P35-40/80	Clamping screw 	Shim 	Wrench 	Clamp 	Shim screw 	Spring 
	a	b	L	h	s	e							
DDJNR/L 10-3A	0.625	0.625	4.00	0.625	0.75	1.18	DN □ □ 33 □ □	CM5×22C	D11BM	WH30L	C1RA	SM5×8.65XA1	SPR6
DDJNR/L 12-3C	0.75	0.75	5.00	0.75	1.00	1.18							
DDJNR/L 16-3D	1.00	1.00	6.00	1.00	1.25	1.18							
DDJNR/L 85-3E	1.25	1.00	7.00	1.25	1.25	1.18							
DDJNR/L 12-4C	0.75	0.75	5.00	0.75	1.00	1.378	DN □ □ 44 □ □	CM6×25C	D15BM	WH40L	C2RA	SM6×10XA1	SPR4
DDJNR/L 16-4D	1.00	1.00	6.00	1.00	1.25	1.378							
DDJNR/L 20-4E	1.25	1.25	7.00	1.25	1.57	1.378							

Applicable toolholders to **SN** □ □ **D-type clamping**









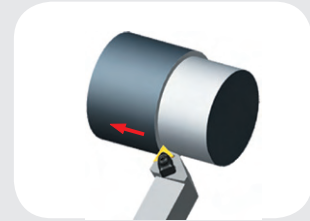
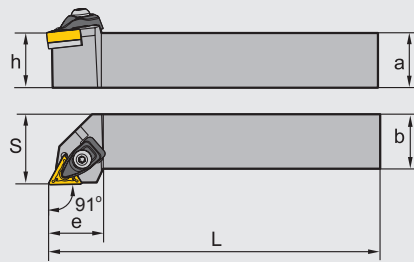

Type	Dimension(inch)						Applicable inserts  P41-45	Clamping screw 	Shim 	Wrench 	Clamp 	Shim screw 	Spring 
	a	b	L	h	s	e							
DSBNR/L 10-3A	0.625	0.625	4.00	0.625	0.512	1.024	SN □ □ 32 □ □	CM5×22C	S09BM	WH30L	C1RA	SM5×8.65XA1	SPR6
DSBNR/L 12-4C	0.75	0.75	5.00	0.75	0.669	1.339	SN □ □ 43 □ □	CM6×25C	S12BM	WH40L	C2RA	SM6×10XA1	SPR4
DSBNR/L 16-4D	1.00	1.00	6.00	1.00	0.866	1.339							
DSBNR/L 85-4E	1.25	1.00	7.00	1.25	0.866	1.339	SN □ □ 54 □ □	CM6×25C	S15BM	WH40L	C3RA	SM6×10XA2	SPR4
DSBNR/L 20-5E	1.25	1.25	7.00	1.25	1.063	1.614							

Applicable toolholders to **TN** □ □ **D-type clamping**

DTGNR/L

91°









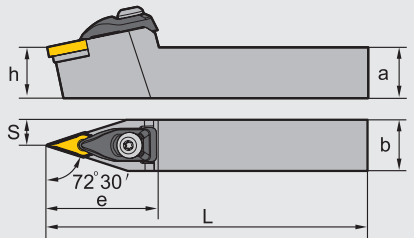

Type	Dimension(inch)						Applicable inserts  P47-51/83	Clamping screw 	Shim 	Wrench 	Clamp 	Shim screw 	Spring 
	a	b	L	h	s	e							
DTGNR/L 10-3A	0.625	0.625	4.00	0.625	0.75	1.00	TN □ □ 33 □ □	CM5×22C	T16BM	WH30L	C1RA	SM5×8.65XA1	SPR6
DTGNR/L 12-3C	0.75	0.75	5.00	0.75	1.00	1.00							
DTGNR/L 16-3D	1.00	1.00	6.00	1.00	1.25	1.00							

Applicable toolholders to **VN** □ □ **D-type clamping**

DVVNN

72°30'







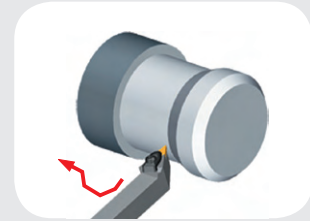
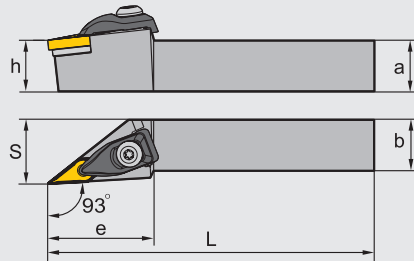

Type	Dimension(inch)						Applicable inserts  P52-53/84	Clamping screw 	Shim 	Wrench 	Clamp 	Shim screw 	Spring 
	a	b	L	h	s	e							
DVVNN 12-3C	0.75	0.75	5.00	0.75	0.394	1.732	VN □ □ 33 □ □	CM5×22C	V16BM	WH30L	C6RA	SM5×8.65XA1	SPR6
DVVNN 16-3D	1.00	1.00	6.00	1.00	0.492	1.732							

Applicable toolholders to **VN** □ □ **D-type clamping**

DVJNR/L 93°







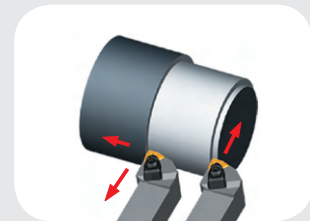
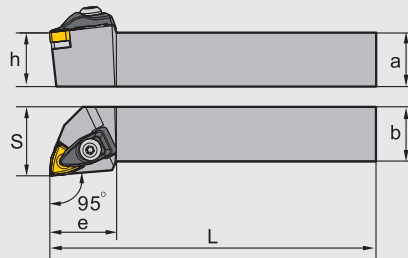

Type	Dimension(inch)						Applicable inserts  P52-53/84	Clamping screw 	Shim 	Wrench 	Clamp 	Shim screw 	Spring 
	a	b	L	h	s	e							
DVJNR/L 12-3C	0.75	0.75	5.00	0.75	1.00	1.614	VN □ □ 33 □ □	CM5 ×22C	V16BM	WH30L	C6RA	SM5×8.65XA1	SPR6
DVJNR/L 16-3D	1.00	1.00	6.00	1.00	1.25	1.614							

Applicable toolholders to **WN** □ □ **D-type clamping**

DWLNR/L 95°







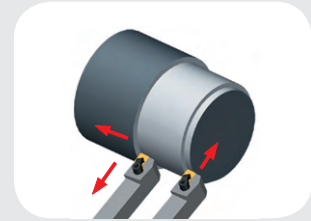
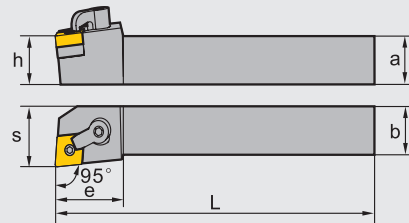
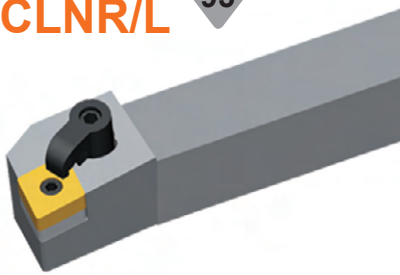

Type	Dimension(inch)						Applicable inserts  P54-57/85	Clamping screw 	Shim 	Wrench 	Clamp 	Shim screw 	Spring 
	a	b	L	h	s	e							
DWLNR/L 10-3A	0.625	0.625	4.00	0.625	0.75	0.945	WN □ □ 33 □ □	CM5×22C	W06BM	WH30L	C1RA	SM5×8.65XA1	SPR6
DWLNR/L 12-3C	0.75	0.75	5.00	0.75	1.00	0.945							
DWLNR/L 16-3D	1.00	1.00	6.00	1.00	1.25	0.945							
DWLNR/L 12-4C	0.75	0.75	5.00	0.75	1.00	1.22	WN □ □ 43 □ □	CM6×25C	W08BM	WH40L	C2RA	SM6×10XA1	SPR4
DWLNR/L 16-4D	1.00	1.00	6.00	1.00	1.25	1.22							
DWLNR/L 85-4E	1.25	1.00	7.00	1.25	1.25	1.22							

Applicable toolholders to **CN**□□ **M-Mulit clamp**

MCLNR/L ^{95°}







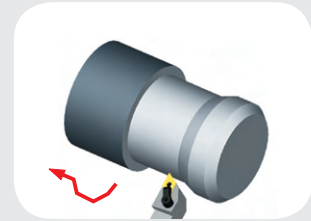
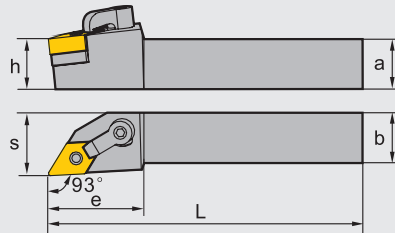
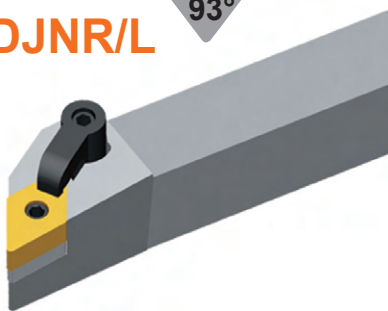

Type	Dimension(inch)						Applicable inserts  P30-34/78	Clamping screw 	Shim 	Wrench 	Clamp 	Clamping stud 
	a	b	L	h	s	e						
MCLNR/L 12-4C	0.75	0.75	5.00	0.75	1.00	1.25	CN□□43□□	DM6×25	C12BM	WH30L	C1RD	TM6×17
MCLNR/L 16-4D	1.00	1.00	6.00	1.00	1.25	1.25		DM6×30				
MCLNR/L 85-4E	1.25	1.00	7.00	1.25	1.25	1.25	CN□□54□□	DM6×30	C16BM	WH30L	C2RD	TM8×21
MCLNR/L 16-5D	1.00	1.00	6.00	1.00	1.25	1.50						
MCLNR/L 20-5E	1.25	1.25	7.00	1.25	1.57	1.50	CN□□64□□	DM8×30X	C19BM	WH40L	C5RD	TM10×21
MCLNR/L 20-6E	1.25	1.25	7.00	1.25	1.57	1.77						
MCLNR/L 24-6F	1.50	1.50	8.00	1.50	2.00	1.77						

Applicable toolholders to **DN**□□ **M-Mulit clamp**

MDJNR/L ^{93°}







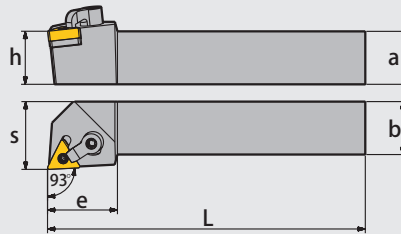
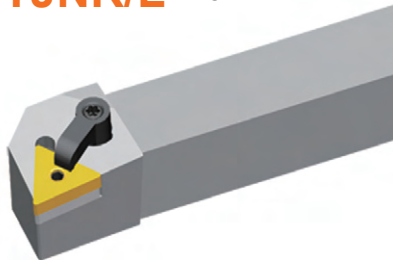

Type	Dimension(inch)						Applicable inserts  P35-40/80	Clamping screw 	Shim 	Wrench 	Clamp 	Clamping stud 
	a	b	L	h	s	e						
MDJNR/L 12-3C	0.75	0.75	5.00	0.75	1.00	1.25	DN□□33□□	DM6×25	D11BM	WH20L WH30L	C1RD	TM5×13
MDJNR/L 16-3D	1.00	1.00	6.00	1.00	1.25	1.25		DM6×30				
MDJNR/L 85-3E	1.25	1.00	7.00	1.25	1.25	1.25	DN□□44□□	DM6×25	D15BM	WH30L	C2RD	TM6×19
MDJNR/L 12-4C	0.75	0.75	5.00	0.75	1.00	1.50						
MDJNR/L 16-4D	1.00	1.00	6.00	1.00	1.25	1.50						
MDJNR/L 85-4E	1.25	1.00	7.00	1.25	1.25	1.50						

Applicable toolholders to **TN** □ □ **M-Mulit clamp**

MTJNR/L 93°







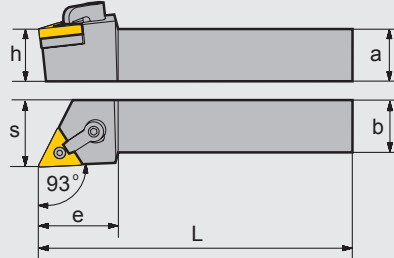
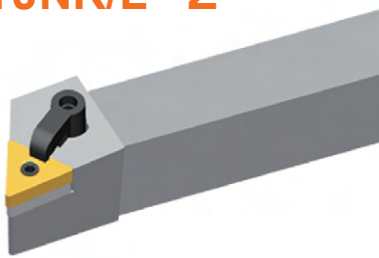

Type	Dimension(inch)						Applicable inserts  P47-51/83	Clamping screw 	Shim 	Wrench 	Clamp 	Clamping stud 
	a	b	L	h	s	e						
MTJNR/L 12-3C	0.75	0.75	5.00	0.75	1.00	1.25	TN □ □ 33 □ □	DM6×25	T16BM	WH20L WH30L	C1RD	TM5×13
MTJNR/L 16-3D	1.00	1.00	6.00	1.00	1.25	1.25		DM6×30				
MTJNR/L 85-3E	1.25	1.00	7.00	1.25	1.25	1.25	TN □ □ 43 □ □	DM6×30	T22BM	WH30L	C2RD	TM6×17
MTJNR/L 16-4D	1.00	1.00	6.00	1.00	1.25	1.42						
MTJNR/L 85-4E	1.25	1.00	7.00	1.25	1.25	1.42						

Applicable toolholders to **TN** □ □ **M-Mulit clamp**

MTJNR/L - Z 93°



Type	Dimension(inch)						Applicable inserts  P47-51/83	Clamping screw 	Shim 	Wrench 	Clamp 	Clamping stud 
	a	b	L	h	s	e						
MTJNR/L 12-3C-Z	0.75	0.75	5.00	0.75	1.00	1.25	TN □ □ 33 □ □	DM6×25	T16BM	WH20L WH30L	C1RD	TM5×13
MTJNR/L 16-3D-Z	1.00	1.00	6.00	1.00	1.25	1.25		DM6×30				
MTJNR/L 85-3E-Z	1.25	1.00	7.00	1.25	1.25	1.25	TN □ □ 43 □ □	DM6×30	T22BM	WH30L	C2RD	TM6×17
MTJNR/L 16-4D-Z	1.00	1.00	6.00	1.00	1.25	1.42						
MTJNR/L 85-4E-Z	1.25	1.00	7.00	1.25	1.25	1.42						





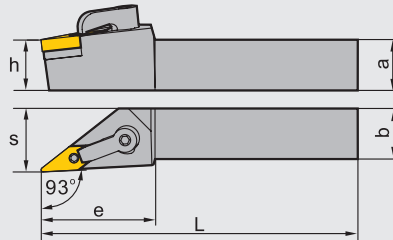
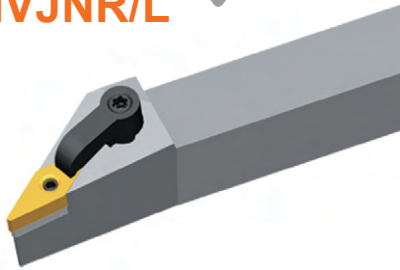

Applicable toolholders to VN □ □

M-Mult clamp

MVJNR/L

93°



Type	Dimension(inch)						Applicable inserts  P52-53/84	Clamping screw 	Shim 	Wrench 	Clamp 	Clamping stud 
	a	b	L	h	s	e						
MVJNR/L 12-3C	0.75	0.75	5.00	0.75	1.00	1.77	VN □ □ 33 □ □	DM6×25	V16BM	WH20L WH30L	C3RD	TM5×13
MVJNR/L 16-3D	1.00	1.00	6.00	1.00	1.25	1.77						
MVJNR/L 85-3E	1.25	1.00	7.00	1.25	1.25	1.77	VN □ □ 33 □ □	DM6×30	V16BM	WH20L WH30L	C3RD	TM5×13
MVJNR/L 20-3E	1.25	1.25	7.00	1.25	1.57	1.77						





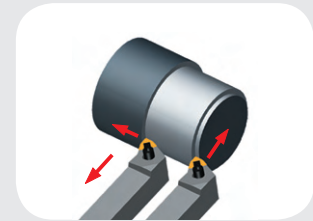
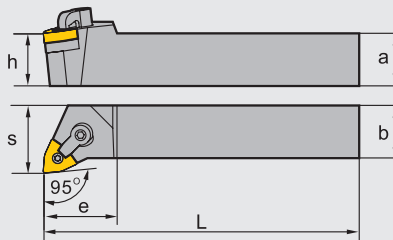

Applicable toolholders to WN □ □

M-Mult clamp

MWLNR/L

95°





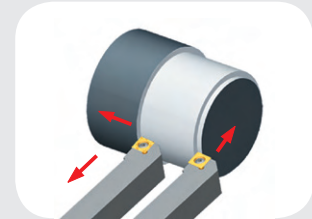
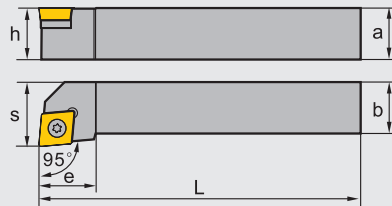
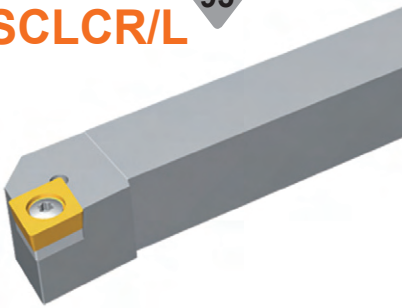

Type	Dimension(inch)						Applicable inserts  P54-57/85	Clamping screw 	Shim 	Wrench 	Clamp 	Clamping stud 
	a	b	L	h	s	e						
MWLNR/L 12-3C	0.75	0.75	5.00	0.75	1.00	1.18	WN □ □ 33 □ □	DM6×25	W06BM	WH20L	C1RD	TM5×13
MWLNR/L 16-3D	1.00	1.00	6.00	1.00	1.25	1.18		DM6×30				
MWLNR/L 12-4C	0.75	0.75	5.00	0.75	1.00	1.18	WN □ □ 43 □ □	DM6×25	W08BM	WH30L	C1RD	TM6×17
MWLNR/L 16-4D	1.00	1.00	6.00	1.00	1.25	1.38		DM6×30				
MWLNR/L 85-4E	1.25	1.00	7.00	1.25	1.25	1.38						
MWLNR/L 20-4E	1.25	1.25	7.00	1.25	1.50	1.38						

Applicable toolholders to **CC**□□□ **S-Screw clamp**

SCLCR/L 95°



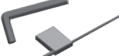

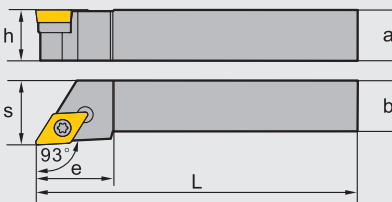

Type	Dimension(inch)						Applicable inserts  P58-59/87	Screw 	Shim 	Shim screw 	Shim Wrench 
	a	b	L	h	s	e					
SCLCR/L 05-2J	0.3125	0.3125	2.36	0.3125	0.39	0.39	CC □□ 2(1.5) □□	I60M2.5×6.5	--	--	WT07IP
SCLCR/L 06-2J	0.375	0.375	2.75	0.375	0.47	0.39					
SCLCR/L 08-3J	0.50	0.50	3.50	0.50	0.63	0.63					
SCLCR/L 10-3A	0.625	0.625	4.00	0.625	0.79	0.63	CC □□ 3(2.5) □□	I60M3.5×8	--	--	WT15IP
SCLCR/L 12-4C	0.75	0.75	5.00	0.75	1.00	1.00					
SCLCR/L 16-4D	1.00	1.00	6.00	1.00	1.25	1.02	CC □□ 43 □□	I60M4×11X	C12BS	SM6×10XA	WT15IP WT40L
SCLCR/L 85-4E	1.25	1.00	7.00	1.25	1.25	1.02					

Applicable toolholders to **DC**□□□ **S-Screw clamp**

SDJCR/L 93°

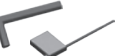

Type	Dimension(inch)						Applicable inserts  P60-61/89	Screw 	Shim 	Shim screw 	Wrench 
	a	b	L	h	s	e					
SDJCR/L06-2J	0.375	0.375	2.75	0.375	0.47	0.60	DC □□ 2(1.5) □□	I60M2.5×6.5	--	--	WT07IP
SDJCR/L08-2J	0.50	0.50	3.50	0.50	0.63	0.60					
SDJCR/L10-2A	0.625	0.625	4.00	0.625	0.79	0.71					
SDJCR/L10-3A	0.625	0.625	4.00	0.625	0.79	0.95	DC □□ 3(2.5) □□	I60M3.5×12	D11BS	SM5×8.65XA	WT15IP WH35L
SDJCR/L12-3C	0.75	0.75	5.00	0.75	1.00	0.95					
SDJCR/L16-3D	1.00	1.00	6.00	1.00	1.25	1.14					
SDJCR/L85-3E	1.25	1.00	7.00	1.25	1.25	1.44					







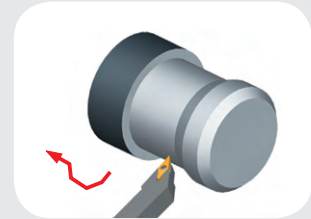
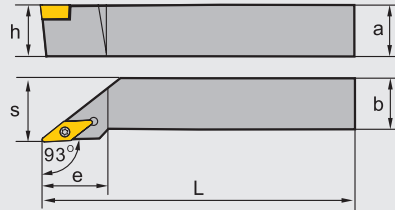
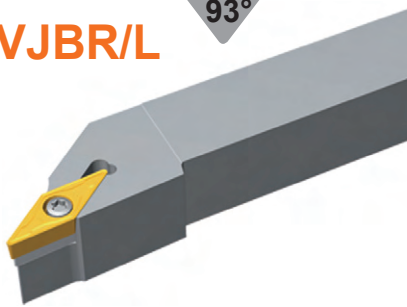

Applicable toolholders to VB□□

S-Screw clamp

SVJBR/L

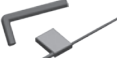
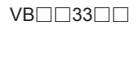
93°

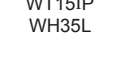

Type	Dimension(inch)						Applicable inserts	Screw	Shim	Shim screw	Wrench
	a	b	L	h	s	e					
SVJBR/L 08-2J	0.50	0.50	3.50	0.50	0.63	1.06	 P69/92				
SVJBR/L 10-2A	0.625	0.625	4.00	0.625	0.79	1.06					
SVJBR/L 12-2C	0.75	0.75	5.00	0.75	1.00	1.06					
SVJBR/L 16-2D	1.00	1.00	6.00	1.00	1.25	1.06					
SVJBR/L 10-3A	0.625	0.625	4.00	0.625	0.79	1.42	 VB□□33□□				
SVJBR/L 12-3C	0.75	0.75	5.00	0.75	1.00	1.61					
SVJBR/L 16-3D	1.00	1.00	6.00	1.00	1.25	1.61					
SVJBR/L 85-3E	1.25	1.00	7.00	1.25	1.25	1.61					







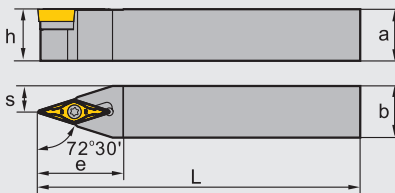

Applicable toolholders to VB□□

S-Screw clamp

SVVBN

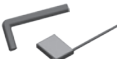
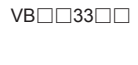
72°30'

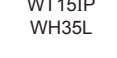

Type	Dimension(inch)						Applicable inserts	Screw	Shim	Shim crew	Wrench
	a	b	L	h	s	e					
SVVBN 08-2J	0.50	0.50	3.50	0.50	0.24	1.06	 P69/92				
SVVBN 10-2A	0.625	0.625	4.00	0.625	0.31	1.06					
SVVBN 12-2C	0.75	0.75	5.00	0.75	0.39	1.18					
SVVBN 10-3A	0.625	0.625	4.00	0.625	0.31	1.30					
SVVBN 12-3C	0.75	0.75	5.00	0.75	0.39	1.30	 VB□□33□□				
SVVBN 16-3D	1.00	1.00	6.00	1.00	0.49	1.50					





Applicable toolholders to VC□□□

S-Screw clamp

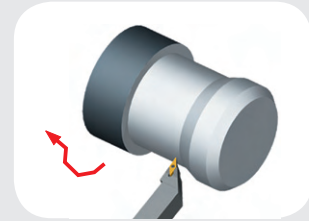
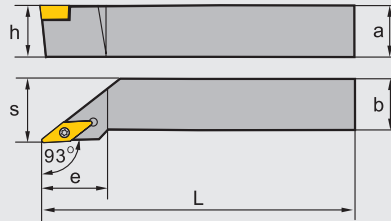
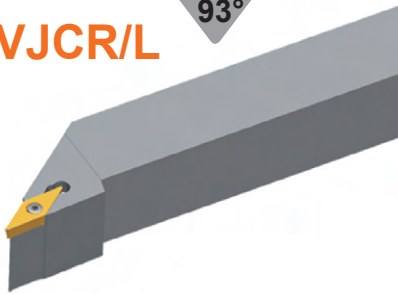
SVJCR/L

93°

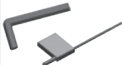

Type	Dimension(inch)						Applicable inserts  P67-68/93	Screw 	Shim 	Shim screw 	Wrench 
	a	b	L	h	s	e					
SVJCR/L 06-2J	0.375	0.375	2.36	0.375	0.47	0.87	VC□□22□□	I60M2.5×6.5	--	--	WT07IP
SVJCR/L 08-2J	0.50	0.50	3.50	0.50	0.63	1.06					
SVJCR/L 10-2A	0.625	0.625	4.00	0.625	0.79	1.06					
SVJCR/L 12-2C	0.75	0.75	5.00	0.75	1.00	1.06					
SVJCR/L 16-2D	1.00	1.00	6.00	1.00	1.25	1.06	VC□□33□□	I60M3.5×12	V16BS	SM5×8.65XA	WT15IP WH35L
SVJCR/L 10-3A	0.625	0.625	4.00	0.625	0.79	1.42					
SVJCR/L 12-3C	0.75	0.75	5.00	0.75	1.00	1.61					
SVJCR/L 16-3D	1.00	1.00	6.00	1.00	1.25	1.61					
SVJCR/L 85-3E	1.25	1.00	7.00	1.25	1.25	1.61					

Applicable toolholders to TC□□

S-Screw clamp



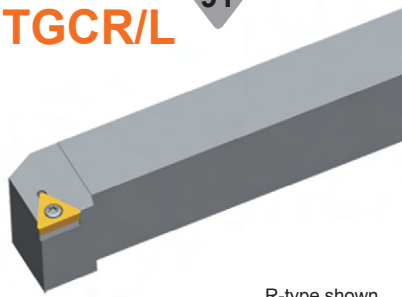

STGCR/L

91°

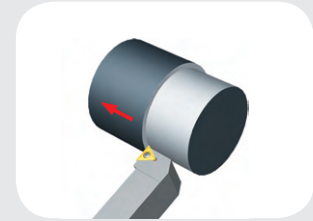
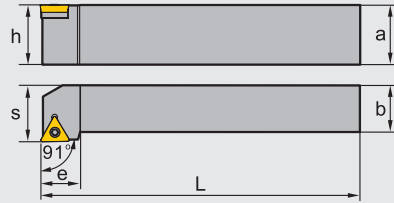

R-type shown

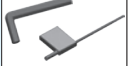

Type	Dimension(inch)						Applicable inserts  P64-66/90-91	Screw 	Shim 	Shim screw 	Wrench 
	a	b	L	h	s	e					
STGCR/L 05-1.8J	0.3125	0.3125	2.36	0.3125	0.39	0.43	TC□□1.8(1.5)□□	I60M2.2×5.5	--	--	WT06IP
STGCR/L 06-1.8J	0.375	0.375	2.36	0.375	0.47	0.43	TC□□1.8(1.5)□□	I60M2.2×5.5	--	--	WT06IP
STGCR/L 08-2J	0.50	0.50	3.50	0.50	0.63	0.55	TC□□2(1.5)□□	I60M2.5×6.5	--	--	WT07IP
STGCR/L 10-2A	0.625	0.625	4.00	0.625	0.79	0.63	TC□□2(1.5)□□	I60M2.5×6.5	--	--	WT07IP
STGCR/L 12-3C	0.75	0.75	5.00	0.75	1.00	0.83	TC□□3(2.5)□□	I60M3.5×12	T16BS	SM5×8.65XA	WT15IP WH35L
STGCR/L 16-3D	1.00	1.00	6.00	1.00	1.25	0.83	TC□□3(2.5)□□	I60M3.5×12	T16BS	SM5×8.65XA	WT15IP WH35L

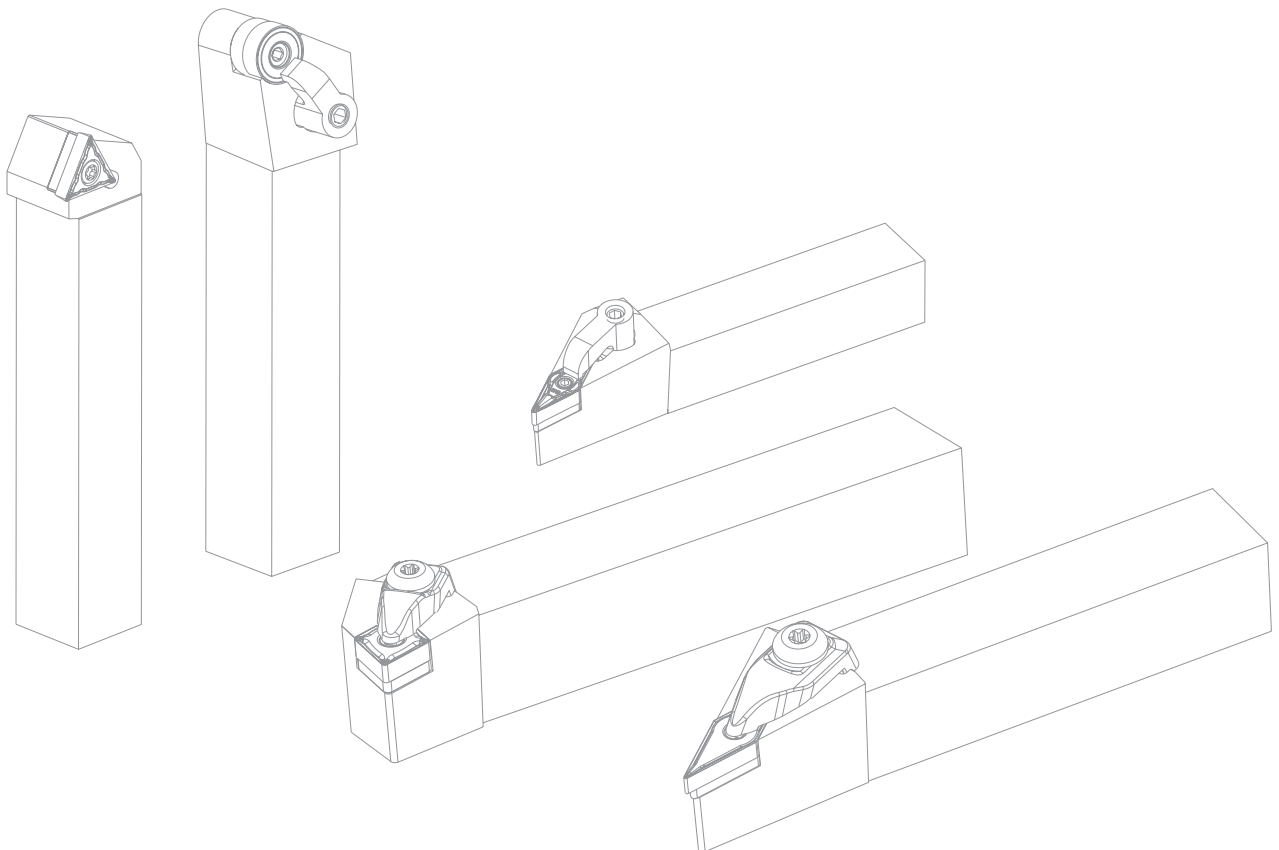

Internal turning tools



Boring Bars code key

Boring bars type	Boring bars diameter	Boring bars length	Insert shape	
Steel with cooling hole A	 Round shanks: shown in 1/16" increments		 C	 D
Carbide C	04 = 0.250" 05 = 0.3125" 06 = 0.375" 08 = 0.500" 10 = 0.625" 12 = 0.750" 16 = 1.000" 20 = 1.250" 24 = 1.500" 32 = 2.000" 40 = 2.500"	H = 4" J = 4-1/2" K = 5" M = 6" Q = 7" R = 8" S = 10" T = 12" U = 14" V = 16" Y = 20"	 K	 R
Carbide with cooling hole E			 S	 T
Steel S			 V	 W

S 16 T - S C L C R - 3





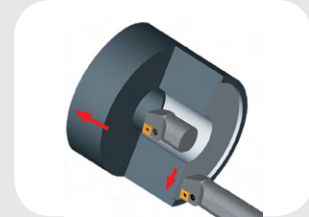
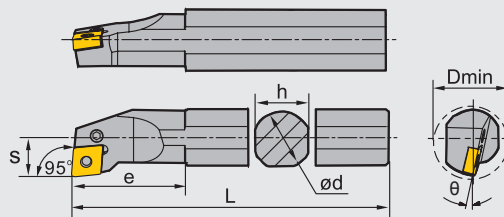

Insert mounting method	Boring bars style	Insert clearance angle	Cutting direction	Insert I.C size
 P-Lever Clamp	 K	 B	 L-Left hand	 Number of 1/8" of inscribed circle
 M-multi Clamp	 F	 C		
 S-Screw Clamp	 U	 D	 R-Right hand	2 = 0.250"
 C-Top Clamp	 L	 E		3 = 0.375"
	 Q	 N		4 = 0.500"
		 P		5 = 0.625"
				6 = 0.750"
				7 = 0.875"
				8 = 1.000"

Applicable Boring bars to **CN**□□

PCLNR/L

95°







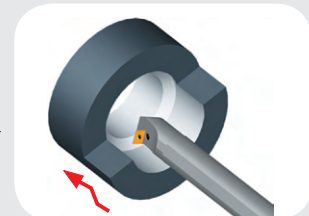
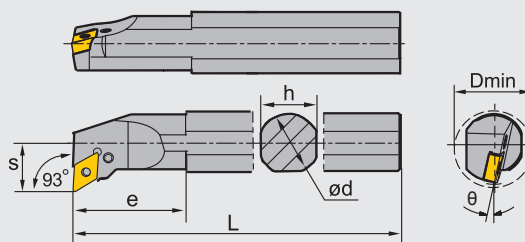

Type	Dimension(inch)							Applicable inserts  P30-34/78	Screw 	Wrench 	Lever 	Shim 	Shim screw 
	D	d	h	L	s	θ	e						
S16Q-PCLNR/L-3	1.26	1.00	0.906	7	0.669	-10°	1.378	CN□□32□□	LEM5x9B	WH20L	L3C	--	--
S16T-PCLNR/L-3	1.26	1.00	0.906	12	0.669	-10°	1.378						
S16Q-PCLNR/L-4	1.26	1.00	0.906	7	0.669	-12°	1.575	CN□□43□□	LEM6x13.4A	WH25L	L4A	--	--
S16T-PCLNR/L-4	1.26	1.00	0.906	12	0.669	-12°	1.575						
A16R-PCLNR/L-4	1.26	1.00	0.945	8	0.669	-12°	1.575						

Applicable Boring bars to **DN**□□

PDUNR/L

93°



Type	Dimension(inch)							Applicable inserts  P35-40	Screw 	Wrench 	Lever 	Shim 	Shim pin 
	D	d	h	L	S	θ	e						
S16Q-PDUNR/L-3	1.26	1.00	0.906	7	0.669	-13°	1.378	DN□□33□□	LEM5x12B	WH20L	L3D	--	--
S16T-PDUNR/L-3	1.26	1.00	0.906	12	0.669	-13°	1.378						

Applicable toolholders to **SN**□□

PSKNR/L

75°

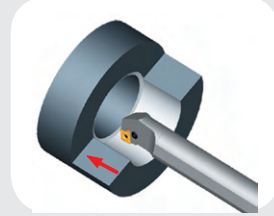
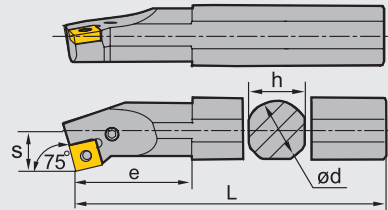

Type	Dimension(inch)							Applicable inserts	Screw	Wrench	Lever	Shim	Shim screw
	D	d	h	L	s	θ	e						
S16Q-PSKNR/L-4	1.26	1.00	0.906	7	0.669	-12°	1.654	P41-45					
S16T-PSKNR/L-4	1.26	1.00	0.906	12	0.669	-12°	1.654	SN□□43□□	LEM6x13.4A	WH25L	L4A	--	--
A16R-PSKNR/L-4	1.26	1.00	0.945	8	0.669	-12°	1.654						

Applicable Boring bars to **TN**□□

PTFNR/L

90°

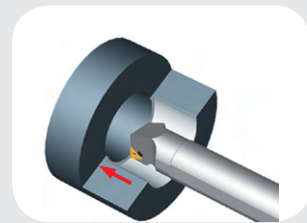
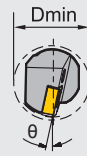
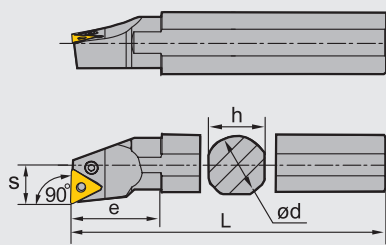









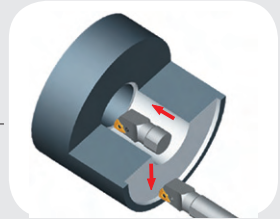
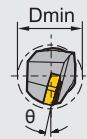
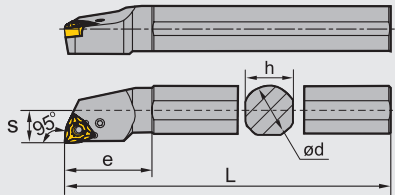



Type	Dimension(inch)							Applicable inserts	Screw	Wrench	Lever	Shim	Shim screw
	D	d	h	L	s	θ	e						
S16Q-PTFNR/L-2	1.26	1.00	0.906	7	0.669	-10°	1.378	P47-51/83					
S16T-PTFNR/L-2	1.26	1.00	0.906	12	0.669	-10°	1.378	TN□□22□□	LEM5x9B	WH20L	L2	--	--
S16Q-PTFNR/L-3	1.26	1.00	0.906	7	0.669	-12°	1.654	TN□□33□□	LEM5x12B	WH20L	L3B	--	--
S16T-PTFNR/L-3	1.26	1.00	0.906	12	0.669	-12°	1.654						
A16R-PTFNR/L-3	1.26	1.00	0.945	8	0.669	-12°	1.575		LEM6x17	WH25L	L3	T16APB	SP3

Applicable toolholders to **WN□□**

PWLNR/L

95°



Type	Dimension(inch)							Applicable inserts	Screw	Wrench	Lever	Shim	Shim screw
	D	d	h	L	s	θ	e						
S16Q-PWLNR/L-3	1.26	1.00	0.906	7	0.669	-13°	1.378	 P54-57/85 WN□□3(2.5)□□ WN□□33□□					
S16T-PWLNR/L-3	1.26	1.00	0.906	12	0.669	-13°	1.378						
S16Q-PWLNR/L-4	1.26	1.00	0.906	7	0.669	-13°	1.772	WN□□43□□					
S16T-PWLNR/L-4	1.26	1.00	0.906	12	0.669	-13°	1.772						
A16T-PWLNR/L-4	1.26	1.00	0.906	12	0.669	-13°	1.772						

Applicable Boring bars to CC□□

SCLCR/L

95°

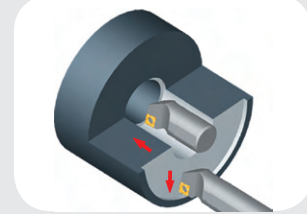
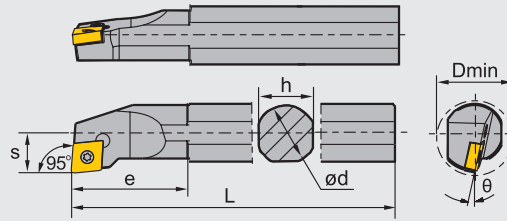





Type	Dimension(Inch)							Applicable inserts  P58-59/87	Screw 	Wrench 	Shim 	Shim screw 
	D	d	h	L	s	θ	e					
S05K-SCLCR/L-2	0.394	0.3125	0.276	5	0.197	-15°	0.551	CC□T2(1.5)□	I60M2.5×5.5	WT07IP	--	--
S06M-SCLCR/L-2	0.472	0.375	0.354	6	0.236	-13°	0.551					
S08M-SCLCR/L-2	0.630	0.500	0.433	6	0.354	-10°	0.984					
S08M-SCLCR/L-3	0.630	0.500	0.433	6	0.354	-10°	0.984	CC□T3(2.5)□	I60M3.5×8	WT15IP	--	--
S10M-SCLCR/L-3	0.787	0.625	0.594	6	0.433	-12°	1.280					
S10R-SCLCR/L-3	0.787	0.625	0.591	8	0.433	-12°	1.280					
S12Q-SCLCR/L-3	0.787	0.750	0.709	7	0.512	-8°	1.496					
S12S-SCLCR/L-3	0.984	0.750	0.709	10	0.512	-8°	1.496	CC□T3(2.5)□	I60M3.5×10	WT15IP	--	--
S16Q-SCLCR/L-3	1.260	1.000	0.906	7	0.669	-6°	1.772					
S16T-SCLCR/L-3	1.260	1.000	0.906	12	0.669	-6°	1.772					
S16Q-SCLCR/L-4	1.260	1.000	0.906	7	0.669	-6°	1.772	CC□T43□	I60M4×11X	WT15IP	--	--
S16T-SCLCR/L-4	1.260	1.000	0.906	12	0.669	-6°	1.772					
S20R-SCLCR/L-4	1.575	1.250	1.181	8	0.866	-10°	1.969	CC□T43□	I60M4×11X	WH40L WT15IP	C12BS	SM6×10xA
S20U-SCLCR/L-4	1.575	1.250	1.181	14	0.866	-10°	1.969					
S24S-SCLCR/L-4	1.969	1.500	1.457	10	1.063	-8°	2.362					
S24V-SCLCR/L-4	1.969	1.500	1.457	16	1.063	-8°	2.362					
A05F-SCLCR/L-2	0.394	0.315	0.295	3.15	0.197	-15°	0.551	CC□T2(1.5)□	I60M2.5×5.5	WT07IP	--	--
A06H-SCLCR/L-2	0.472	0.375	0.374	4	0.236	-13°	0.551					
A08K-SCLCR/L-2	0.630	0.500	0.453	5	0.354	-10°	0.984					
A08K-SCLCR/L-3	0.630	0.500	0.453	5	0.354	-10°	0.984	CC□T3(2.5)□	I60M3.5×8	WT15IP	--	--
A10M-SCLCR/L-3	0.787	0.625	0.610	6	0.433	-12°	1.280					
A12Q-SCLCR/L-3	0.984	0.750	0.748	7	0.512	-8°	1.496					
A16R-SCLCR/L-3	1.260	1.000	0.945	8	0.669	-6°	1.772					
A16R-SCLCR/L-4	1.260	1.000	0.945	8	0.669	-6°	1.772	CC□T43□	I60M4×11X	WT15IP WH40L WT15IP	C12BS	SM6×10XA
A20S-SCLCR/L-4	1.575	1.250	1.220	10	0.866	-10°	1.969					

Applicable Boring bars to **DC**□□

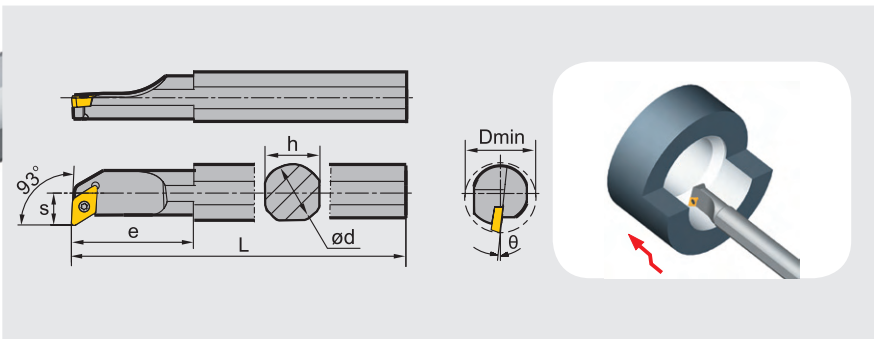
SDUCR/L

93°



Type	Dimension(inch)							Applicable inserts	Screw	Wrench
	D	d	h	L	s	θ	e	 P60-61/89		
S06M-SDUCR/L-2	0.512	0.375	0.354	6	0.276	-8°	0	DC□T2(1.5)□	I60M2.5×5.5	WT071P
S08M-SDUCR/L-2	0.630	0.500	0.433	6	0.354	-8°	0.866		I60M2.5×6.5	
S10M-SDUCR/L-2	0.787	0.625	0.591	6	0.433	-6°	1.063			
S10R-SDUCR/L-2	0.787	0.625	0.591	8	0.433	-6°	1.063			
S12Q-SDUCR/L-3	0.984	0.750	0.709	7	0.512	-6°	1.575	DC□T3(2.5)□	I60M3.5×8	WT151P
S12S-SDUCR/L-3	0.984	0.750	0.709	10	0.512	-6°	1.575		I60M3.5×10	
S16Q-SDUCR/L-3	1.260	1.000	0.906	7	0.669	-6°	1.811			
S16T-SDUCR/L-3	1.260	1.000	0.906	12	0.669	-6°	1.811			
A06H-SDUCR/L-2	0.512	0.375	0.374	4	0.276	-8°	0	DC□T2(1.5)□	I60M2.5×5.5	WT071P
A08K-SDUCR/L-2	0.630	0.500	0.453	5	0.354	-8°	0.866		I60M2.5×6.5	
A10M-SDUCR/L-2	0.787	0.625	0.610	6	0.433	-6°	1.063			
A12Q-SDUCR/L-3	0.984	0.750	0.748	7	0.512	-6°	1.575			
A16R-SDUCR/L-3	1.260	1.000	0.945	8	0.669	-6°	1.811	DC□T3(2.5)□	I60M3.5×8	WT151P
									I60M3.5×10	

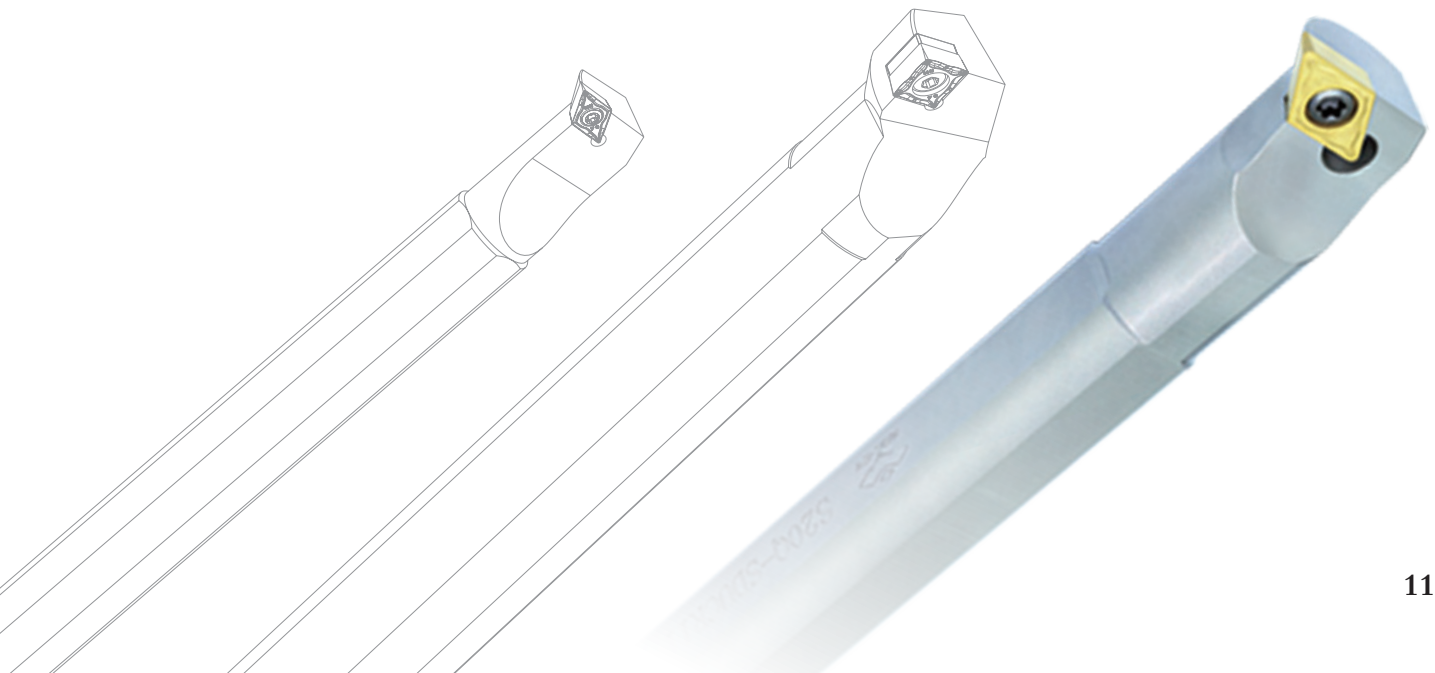

Applicable Boring bars to TC□□

STFCR/L

90°

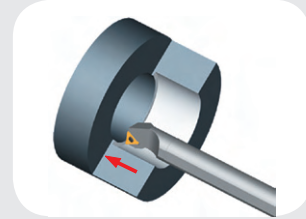
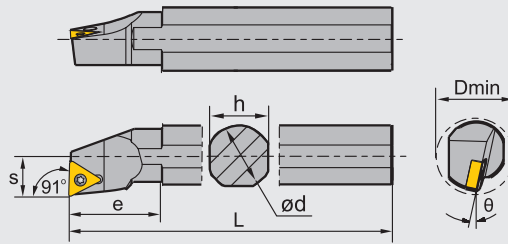

Type	Dimension(inch)							Applicable inserts P64-66/90-91	Screw	Wrench	Shim	Shim screw
	D	d	h	L	s	θ	e					
S08M-STFCR/L-2	0.630	0.500	0.433	6	0.354	-10°	1.181	TC□T2(1.5)□	I60M2.5×6.5	WT07IP	--	--
S10M-STFCR/L-2	0.787	0.625	0.591	6	0.433	-6°	1.378					
S10R-STFCR/L-2	0.787	0.625	0.591	8	0.433	-6°	1.378					
S12Q-STFCR/L-2	0.984	0.750	0.709	7	0.512	-3°	1.417					
S12S-STFCR/L-2	0.984	0.750	0.709	10	0.512	-3°	1.417					
S16Q-STFCR/L-3	1.260	1.000	0.906	7	0.669	-6°	1.929					
S16T-STFCR/L-3	1.260	1.000	0.906	12	0.669	-6°	1.292					
S20R-STFCR/L-3	1.575	1.250	1.181	8	0.866	-10°	1.969	TC□T3(2.5)□	I60M3.5×10	WT15IP	--	--
S20U-STFCR/L-3	1.575	1.250	1.181	14	0.866	-10°	1.969					
S24S-STFCR/L-3	1.969	1.500	1.457	10	1.063	-8°	2.362					
S24V-STFCR/L-3	1.969	1.500	1.457	16	1.063	-8°	2.362					
A08K-STFCR/L-2	0.630	0.500	0.453	5	0.354	-10°	1.024	TC□T2(1.5)□	I60M2.5×6.5	WT07IP	--	--
A10M-STFCR/L-2	0.787	0.625	0.610	6	0.433	-6°	1.181					
A12Q-STFCR/L-2	0.984	0.750	0.748	7	0.512	-3°	1.417					
A16R-STFCR/L-3	1.260	1.000	0.946	8	0.669	-6°	1.772	TC□T3(2.5)□	I60M3.5×10	WT15IP	--	--
A20S-STFCR/L-3	1.575	1.250	1.220	10	0.866	-10°	1.929					

Recommended cutting parameters for general turning

ISO	Materials		Hardness HB	CVD Coating					PVD Coating			Cermet	Coated cermet	Cemented carbide		
				YBC151	YBC251	YBC152	YBC252	YBC351	YBG102	YBG202	YBG205	YNG151	YNG151C	YC10	YC40	
				Feed rate (inch/rev)												
				0.004-0.024	0.004-0.031	0.004-0.024	0.004-0.031	0.008-0.039	0.008-0.016	0.004-0.024	0.002-0.031	0.002-0.008	0.002-0.008	0.004-0.016	0.004-0.020	
				Cutting speed (SFPM)												
P	Carbon steel	C=0.15%	125	1400-650	1400-600	1650-900	1600-800	1200-550	1500-700	1200-600	1200-500	1800-1100	1900-1100	1200-550	1000-500	
		C=0.35%	150	1200-600	1300-600	1500-800	1500-750	1000-500	1400-700	1000-550	1000-550	1600-1000	1700-1000	900-500	700-400	
		C=0.60%	200	1000-500	1200-500	1300-700	1300-650	850-400	1200-600	850-500	900-550	1500-850	1600-850	800-400	600-260	
	Alloy steel	Anneal	180	1100-550	1200-500	1300-600	1300-650	650-300	1200-600	650-400	700-450	1300-800	1400-800	600-300	500-260	
		Hardened	275	750-300	700-300	900-500	850-450	450-230	800-400	450-300	500-300	1000-600	1000-600	400-230	400-160	
		Hardened	300	700-300	600-230	850-500	800-400	400-200	700-300	400-260	450-300	800-560	900-550	300-200	260-130	
		Hardened	350	600-260	550-230	750-400	700-400	350-200	650-300	360-240	400-260	800-500	800-500	300-180	230-150	
	High alloy steel	Anneal	200	1000-500	850-400	1200-600	1000-550	550-260	1000-500	600-300	600-300	1100-650	1200-650	500-260	450-200	
		Hardene	325	450-300	300-160	600-400	500-300	300-130	400-260	300-200	300-200	550-360	600-360	200-130	150-100	
	Cast steel	Non-Alloy	180	800-400	650-300	900-500	800-450	450-240	750-400	450-300	450-300	850-560	1000-550	400-240	300-200	
		Low alloy	200	750-230	550-200	900-350	700-350	400-260	650-300	400-300	400-350	850-560	1000-550	300-360	260-200	
		High alloy	225	500-230	450-160	700-350	600-300	300-180	550-260	300-180	300-200	850-300	900-300	300-180	240-110	

ISO	Materials		Hardness HB	CVD Coating			PVD Coating		Cermet	Coated cermet
				YBM151	YBM251	YBM253	YBG202	YBG205	YNG151	YNG151C
				Feed rate (inch/rev)						
				0.008-0.024	0.008-0.024	0.008-0.024	0.004-0.016	0.008-0.016	0.004-0.012	0.004-0.012
				Cutting speed (SFPM)						
M	Stainless steel	Ferrite	180	900-600	800-450	850-450	1000-600	1000-650	1100-700	1100-700
		Austenite	260	800-500	650-360	700-360	800-500	900-550	800-500	900-450
		Martensite	330	650-450	700-400	750-400	850-550	850-500	900-550	1000-500

Recommended cutting parameters for general turning

ISO	Materials		Hardness HB	CVD Coating					Cermet	Coated cermet	Cemented carbide	
				YBD052	YBD151	YBD102	YBD152	YBD252	YNG151	YNG151C	YC10	YC40
				Feed rate(inch/rev)								
				0.004-0.016	0.004-0.024	0.004-0.016	0.004-0.020	0.004-0.031	0.004-0.016	0.004-0.016	0.004-0.012	0.004-0.016
Cutting speed(SFPM)												
K	Malleable cast iron	Ferrite	130	1150-750	1000-700	1000-700	1050-350	800-550	1000-500	1000-600	500-300	3500-150
		Pearlite	230	800-350	700-300	750-300	750-300	600-250	700-400	800-500	400-230	260-100
	Low cast iron	180	1700-650	1500-600	1500-650	1600-600	1250-500	1300-800	1400-900	550-300	400-200	
	High cast iron	260	750-400	700-350	700-400	700-300	550-300	1200-800	1200-850	400-230	300-130	
	Nodular Cast iron	Ferrite	160	1000-500	1000-450	1000-500	950-450	700-350	1100-600	1200-700	450-260	400-150
Pearlite		250	750-350	700-300	700-350	700-300	550-300	1000-650	1100-700	360-230	260-100	

ISO	Materials			Hardness HB	PVD Coating				Cemented carbide
					YBG102	YBG105	YBG202	YBG212	YD101
					Feed rate (inch/rev)				
					0.002-0.006				0.002-0.014
Cutting speed (SFPM)									
N	Al alloy	No heat treatment		60					5700-2600
		Heat treatment		100					1700-800
	Cast aluminum alloy	No heat treatment		75					1500-600
		Heat treatment		90					1000-360
	Copper alloy	Lead alloy		110					2000-650
		Copper,pure copper		90					1000-650
Copper,nonleaded Copper,electrolytic copper		100					700-400		
S	Ni-base alloy	Ni-base alloy		40	300-100	300-130	300-100	300-100	230-70

ISO	Materials	Hardness	Feed rate (inch/rev)	Grade			
				YCB012	YCB011	YBZ221	YCD011
				Cutting speed (SFPM)			
H	Hard steel	45HRC	0.1-0.2	500-820			
			0.1-0.2				
			0.1-0.3				
	Super hard steel	50-60HRC	0.1-0.2	500-656			
			0.1-0.2				
			0.1-0.5				
K	Grey cast iron	170-220HB	0.1-0.5	1300-4900			
			0.1-0.5				
			0.5-1.0	1300-4900			
	Ductile cast iron	170-230HB	0.1-0.2	320-980			
			0.1-0.2				
			0.3-1.5	320-1600			
Chilled cast iron	500HB	0.1-0.5	160-490				
		0.1-0.5					
		0.5-1.5	65-160				
N	Aluminum silicon alloy(≤12%Si)	75-90	0.1-0.4			2950-16400	
	Aluminum silicon alloy(>12%Si)	80-110	0.1-0.4			980-2950	
	Copper alloy	90-110HB	0.1-0.3			1300-3900	
	Reinforced plastics		0.1-0.5			650-3200	

● Frequent problems of turning and solutions



Common problem	Cause	Solutions		Tool material		Cutting conditions				Tool shape					Machine clamping system		
		Harder materials	Tougher materials	Cutting speed	Feed rate	Cutting depth	Cutting liquid	Change chipbreaker of inserts	Rake face	Nose radius	Approach angle	Cutting edge strength	Increase precision of inserts	Increase rigidity of tool holder	Clamping of toolholder and workpiece	Overhang of toolholder	Power, gap
Over abrasion on nose	Bad precision during machining	✓								↑							
	Unsuitable cutting conditions			↓	↑												
Surface precision deterioration	Abrasion intensified and cutting edge not sharp enough	✓		↓			✓		↑	↑		↓	✓				
	Breakage		✓		↓	↓		✓		↑		↑			✓	✓	✓
	Unsuitable geometrical shape of cutting edge							✓		↑		↓	✓				
	Unsuitable cutting conditions			↑	↓	↓	✓										
	Shake and vibration		✓	↑	↓	↓	✓	✓	↑	↓	↑	↓		✓	✓	✓	✓
	Built-up edge				↑	↑		✓	✓	↑		↓	✓				
Radiation	Effect of cutting heat			↓	↓	↓											
	Unsuitable geometrical shape of cutting edge	✓						✓	↑			↓					
Bad precision of dimensions	Dimensions fluctuate during cutting												✓				
	Location removed of workpiece or tools							✓	↑	↓	↑			✓	✓	✓	✓
Breakage	Abrasion intensified on flank and rake face	✓		↓				✓	↑	↑		↓					
	Abrasion on rake face	✓		↓	↓	↓		✓	↑		↓						
	Light breakage		✓		↓	↓		✓			↓	↑		✓	✓	✓	✓
	Built-up edge			↑	↑		✓	✓	↑		↓	✓					
	Thermal cracking			↓	↓	↓	✓	✓	↑		↓						
	Cutting edge nose deformation	✓		↑	↓	↓	✓	✓	↑	↑	↓	↓					
	Tool life		✓		↓	↓		✓		↑	↓	↑		✓	✓	✓	✓
Chip controlling	Intertwist of long chips			↓	↑	↑	✓				↓	↑					
	Unsuitable geometry							✓		↓	↑						
	Too short chips lead to splash				↓	↓	✓				↑	↓					
Burr and knockdown flange	Steel and Al, burrs occurring	✓		↑	↓		✓		↑	↓	↑	↓					
	Unsuitable tool abrasion and geometrical shape	✓						✓	↑	↓	↑	↓					
	Cast iron, knockdown flange	✓		↓	↑		✓		✓	↓	↓	↓					
Soft steel, raw edges	Unsuitable cutting condition			↓	↓												
	Unsuitable tool abrasion and geometrical shape	✓						✓	↑	↑		↑		✓	✓	✓	✓











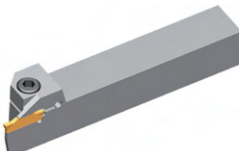
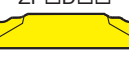

Turning

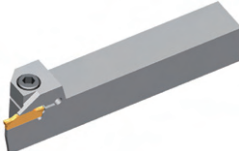

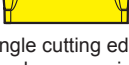



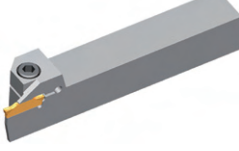
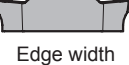



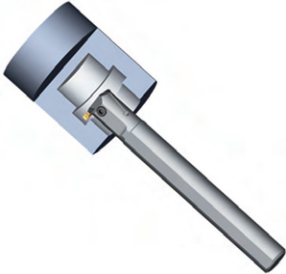

PARTING AND GROOVING TOOLS

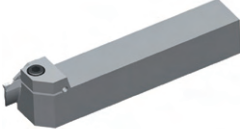
Parting and grooving tools overview	P120-125
Parting, grooving and profiling inserts code key	P126
Parting, grooving and profiling inserts	P127-131
External and Face cutting tools code key	P132
Parting, grooving tools	P133-139
Internal cutting tools code key	P140
Internal grooving and turning tools	P141
Recommended cutting parameters for parting and grooving	P142
General information	P143

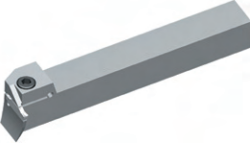
● Parting and grooving tools overview

Machining application	Machining type	Applicable tools	Corresponding inserts	Tool's feature and parameters
External machining	Parting	The little squirrel series QZ□□+QE□□  P136-137	Parting inserts ZP□□□□ 	<ul style="list-style-type: none"> Assemble structure of parting blade and holder, good rigidity and parting range is adjustable. The maximum parting diameter is 4.724inch.
		The little squirrel series QE□□R/L  P133-134	ZP□□□□  ZP□□□□ 	<ul style="list-style-type: none"> Inserts have 3d chipbreaker, small cutting force, good performance on chip breaking The maximum parting diameter is 2.362inch.
	Grooving and turning	The little squirrel series QE□□R/L  P133-134	Double cutting edges for parting ZT□□□□  Profile turning ZR□□□□  Single cutting edge for deep grooving ZT□□□□ 	<ul style="list-style-type: none"> Various applications can be realised by one single tool, installed with different inserts for grooving, profiling and parting. It reduces the tool category. Installed with grooving inserts, the tool realizes grooving and transverse cutting. It's multifunction tool The maximum slot depth can be machined is 1.181inch.
	Precise grooving	The little squirrel series QE□□  P135	Precise grooving ZT□□□□-EG  Edge width 0.047~0.094inch	<ul style="list-style-type: none"> Grinded insert, used for precise grooving. Edge width can be any size between 0.039~0.256inch according to customers, requirement. ZT□□□□-EG inserts: When edge width is between 0.047~0.094inch, the maximum cutting depth is 0.098inch; When edge width is >0.094~0.256inch, the maximum cutting depth is 0.866inch.
		The little squirrel series QE□□R/L  P133-134	Precise grooving ZT□□□□-EG  Edge width 0.039~0.256inch	

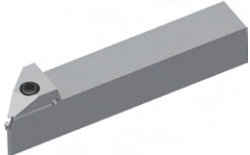
B

Machining application	Machining type	Applicable tools	Corresponding inserts	Tool's feature and parameters
Internal machining	Grooving and turning 	The little squirrel series C□□-Q□□R/L□  P141	Grooving, Turning ZT□□□□  Profile turning ZR□□□□ 	<ul style="list-style-type: none"> By installing different inserts for grooving and profiling, one single tool realizes various applications, it reduce the tool category. The maximum slot depth can be machined is 0.512inch. The minimum diameter can be machined is 1.063inch.
End machining	Grooving and turning 	The little squirrel series QF□□□□H  P137-138	Grooving, Turning ZT□□□□  Profile turning ZR□□□□ 	<ul style="list-style-type: none"> By installing different inserts as for grooving and profiling, one single tool realizes various applications, it reduces the tool category. Grooving diameter 1.890~15.748inch. Grooving depth 0.394~1.181inch.
		The little squirrel series QF□□□□L  P139	Grooving, Turning ZT□□□□  Profile turning ZR□□□□ 	<ul style="list-style-type: none"> 90°toolholder, top clamping By installing different inserts as for grooving and profiling, one single tool realizes various applications, it reduce the tool category. Grooving diameter 1.890~15.748inch. Grooving depth 0.394~1.181inch.
Recess machining	Recess and turning 	The little squirrel series QX□□□□□□  P135	Grooving, Turning ZT□□□□  Profile turning ZR□□□□ 	<ul style="list-style-type: none"> The unique tool for recess machining. Various recess machining can be realized, inserts specification is complete.

Little squirrel
series

-EG

Precise grooving and profile turning inserts

Special chipbreaker design, suitable for precise grooving of low-carbon steel, stainless steel, adhesive materials and non-ferrous metal.

-EG Precise grooving inserts

The edge width can be anything between 0.039-0.256inch according to your requirements.

0.039~0.094inch

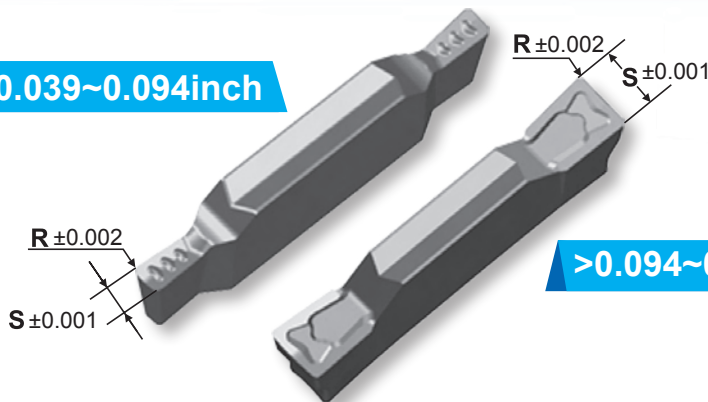

>0.094~0.256inch

The tolerance of the edge width S of precise grooving and profiling inserts can reach ± 0.001 . Inserts can also be mounted on the corresponding specifications of original tool series.

-EG Precise profile turning inserts

The Little Squirrel series precise profiling and turning inserts are mainly used for Precise grooving and profiling.

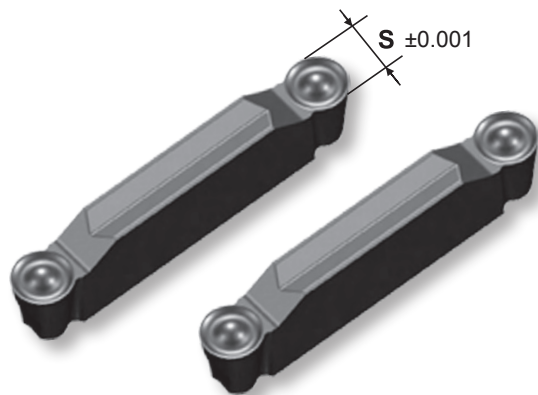

The width of the Little Squirrel series precise grooving inserts can be anything between 0.039inch to 0.256inch, which means products with any edge width or nose radius can be provided according to customers' requirements. The inserts are mainly used for precise grooving, such as sealing slot and locating slot, etc.

-MG Little squirrel series

-MG Series Chipbreaker

Suitable for parting, grooving, profiling, and turning. Good chip control and chip evacuation for good surface finish.

Insert design allows for use in many applications with need for fewer insert grades and configurations.

Inserts with the same cutting edge width can be used with different holders. Standardization with fewer inserts for internal, external, grooving and turning reduces tool inventory and tool management cost.

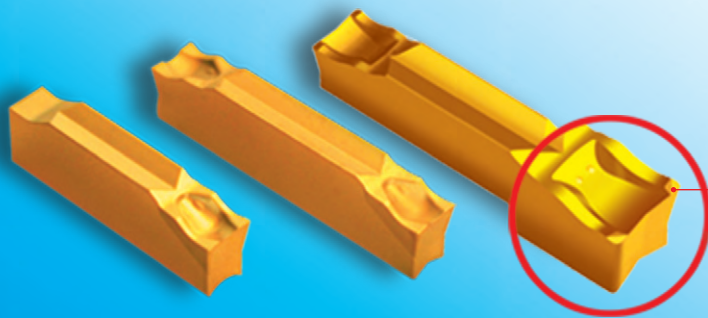
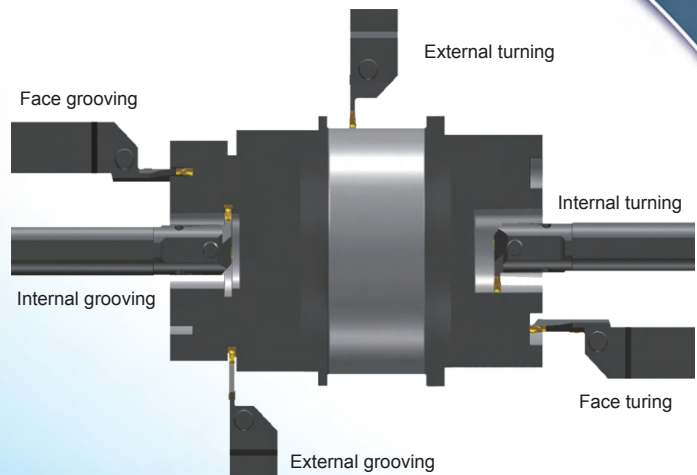

20% reduction in cutting force and reduced ovality.

Unique design of parting insert

- Insert uses specially designed flank to reduce cutting resistance by 20% with reduced machined surface ovality.
- A special design of the cutting edge requires less rigidity of machine. Older and lower horsepower machines can be used more productively.

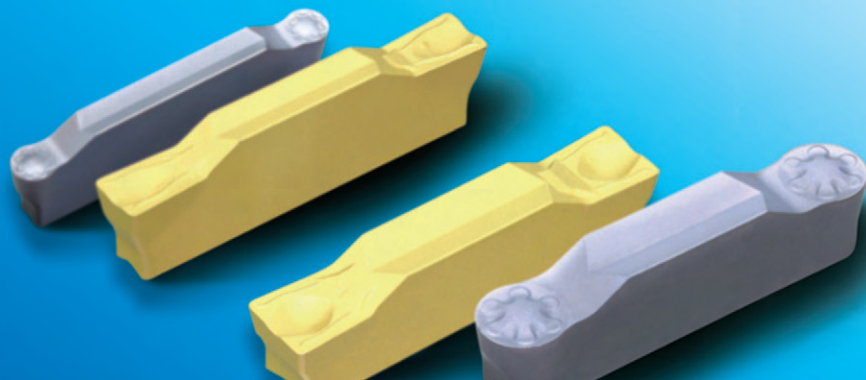

Little-Squirrel Series

Profile turning inserts for parting of aviation titanium alloy and high-temperature alloy

-NF

Single-headed precision profile turning inserts

Sharp edge, small cutting force, good surface quality;
Indexing accuracy reaches ± 0.001 inch, safe and stable clamping;
Mainly applied in finishing of high-temperature alloy, titanium alloy.

-NM

Precision profile turning inserts

Sharp edge, small cutting force, good surface quality;
Indexing accuracy reaches ± 0.001 inch;
Highly economical, two edges available;
Compatible with little squirrel tool holder, suitable for small depth profile finishing and semi-finishing of high-temperature alloy and Ti-alloy.

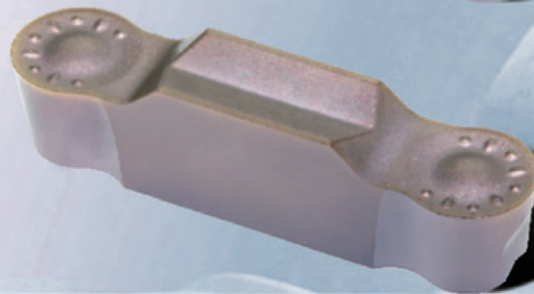
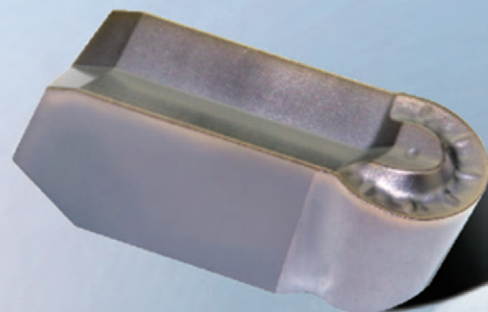

-SM

Single-headed groove turning inserts

Straight edge, excellent surface quality;
Sharp edge, smaller cutting force;
Good chip breaking;
Mainly used for rough machining of high-temperature alloy and titanium alloy.

-MM

Straight edge groove turning inserts

High edge strength, sharp edge;
Highly economical, two edges available, compatible with little squirrel tool holder;
With special grades, suitable for roughing with small cutting depths of high-temperature alloy and titanium alloy.

Case

Insert: YBG105/ZIMF604N-SM
Hardness of workpiece material: GH4169 (HB380)
Cutting data: $V=150$ SFPM, $f=0.008$ in/r
Coolant: Water



Products of company A



YBG105/ZIMF604N-SM

Conclusion: Under the same conditions, chip breaking performance is better and the time for stopping the removal of long winding chips is reduced.

Parting, grooving and profiling inserts code key

B

Application of inserts

- ZP > Parting
- ZR > Profile machining
- ZT > Grooving and turning

Code of locating slot

Code of locating slot	A	B	E	F	G	H	K
Width of cutting edge	0.059	0.079	0.098	0.118	0.157	0.197	0.236

Number of cutting edge

- S > Single cutting edge
- D > Double cutting edges

ZP G D 04 04 - M G

Width of cutting edge

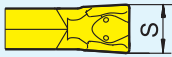

01=0.059"	02=0.079"
02=0.098"	05=0.197"
03=0.118"	06=0.236"
04=0.157"	

Nose radius

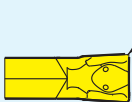

02=0.008"	04=0.016"
03=0.012"	06=0.236"

Tolerances

- M > M class tolerance
- E > E class tolerance

Tolerances

- G > General chip-breakers, suitable for all kinds of machined materials
- F > Special chip-breakers

Parting inserts

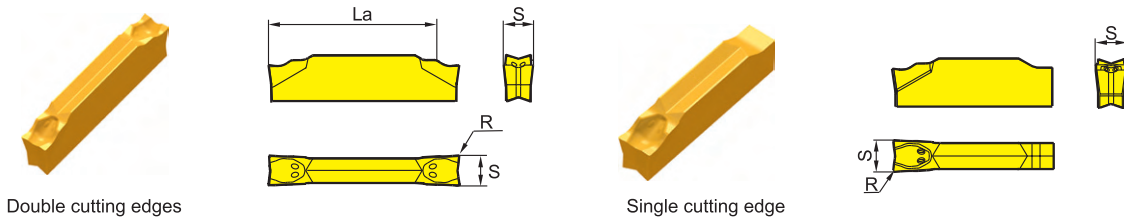

Double cutting edges

Single cutting edge

Type	Dimension(inch)			Grade								
	S ^{+0.004} ₀	R±0.002	L _{max}	P		M			K			
				YBG202	YBG302	YBG202	YBG302	YD201	YBG302	YD201	YBG102	
Double cutting edges	ZPAD01502-MG	0.059	0.008	0.472		○		○		○		
	ZPBD0202-MG	0.079	0.008	0.551		○		○		○		
	ZPED02502-MG	0.098	0.008	0.670	○	●	○	●		●		
	ZPFD0302-MG	0.118	0.008	0.670		○		○		○		
	ZPGD0402-MG	0.157	0.008	0.866		○		○		○		
	ZPHD0503-MG	0.197	0.012	0.866		○		○		○		
Single cutting edge	ZPKD0604-MG	0.236	0.016	0.866		○		○		○		
	ZPES02502-MG	0.098	0.008	--	○	●	○	●		●		
	ZPFS0302-MG	0.118	0.008	--		○		○		○		
	ZPGS0402-MG	0.157	0.008	--		○		○		○		
	ZPHS0503-MG	0.197	0.012	--		○		○		○		
ZPKS0604-MG	0.236	0.016	--		○		○		○			

Insert with single cutting edge only be used to parting blade

● Always stock available ○ Produce according to order

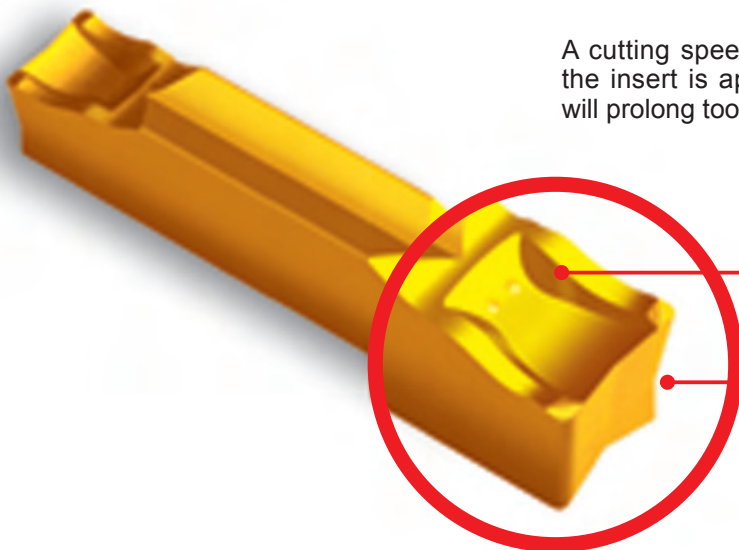

A cutting speed reduction of 30% is preferred when the insert is approaching the workpiece. This action will prolong tool life.

Enhanced chipbreaker design improves chip control.

20% cutting force reduction and reduced vibrations.

Grooving, turning inserts

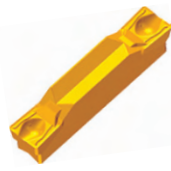

Double cutting edges

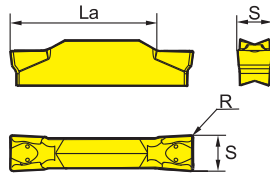

Single cutting edge

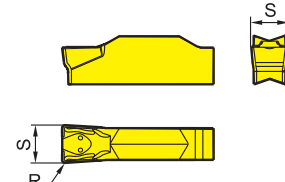

Type	Dimension(inch)			Grade								
	S ^{+0.004} ₀	R±0.002	L _a max	P		M			K			
				YBG202	YBG302	YBG202	YBG302	YD201	YBG302	YD201	YBG102	
Double cutting edges												
ZTED02503-MG	0.098	0.012	0.670	●	●	●	●		●			
ZTFD0303-MG	0.118	0.012	0.670	●	●	●	●		●			
ZTGD0404-MG	0.157	0.016	0.866	●	●	●	●		●			
ZTHD0504-MG	0.197	0.016	0.866	●	●	●	●		●			
ZTKD0608-MG	0.236	0.031	0.866	●	●	●	●		●			
Single cutting edge												
ZTHS0504-MG	0.197	0.016	--	○	○	○	○		○			
ZTKS0608-MG	0.236	0.031	--	○	○	○	○		○			

● Always stock available ○ Produce according to order

Grooving, turning inserts

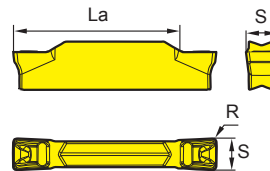

Type	Dimension(inch)			Grade								
	S ^{+0.004} ₀	R±0.002	L _a max	P		M			K			
				YBG202	YBG302	YBG202	YBG302	YD201	YBG302	YD201	YBG102	
Double edges												
ZTAD01502-MM	0.059±0.001	0.008	0.472	●	○	●	○		○			
ZTBD02002-MM	0.079±0.001	0.008	0.551	●	○	●	○		○			
ZTED02503-MM	0.098±0.001	0.012	0.670	●	○	●	○		○			
ZTFD0303-MM	0.118±0.001	0.012	0.670	●	○	●	○		○			
ZTGD0404-MM	0.157±0.002	0.016	0.866	●	○	●	○		○			
ZTHD0504-MM	0.197±0.002	0.016	0.866	●	○	●	○		○			
ZTKD0608-MM	0.236±0.002	0.031	0.866	●	○	●	○		○			
ZTLD0808-MM	0.315±0.002	0.031	1.102	●	○	●	○		○			

● Always stock available ○ Produce according to order

Precision grooving and turning inserts

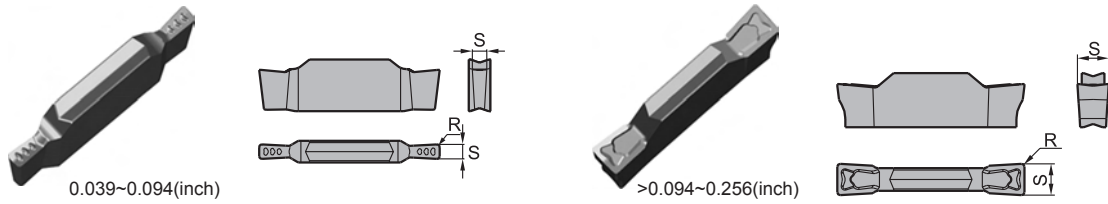

Type	Dimension(inch)			Grade								
	S $\begin{smallmatrix} +0.004 \\ 0 \end{smallmatrix}$	R \pm 0.002	L $_{max}$	P		M			K			
				YBG202	YBG302	YBG202	YBG302	YD201	YBG302	YD201	YBG102	
Double cutting edges	ZTCD□□□□ ⁽¹⁾ -EG	0.039-0.094	Please see annotations (2)	0.670	○	○	○	○	○	○	○	
	ZTED□□□□-EG	0.094-0.118		0.670	○	○	○	○	○	○	○	
	ZTFD□□□□-EG	0.118-0.150		0.670	○	○	○	○	○	○	○	
	ZTGD□□□□-EG	0.150-0.189		0.866	○	○	○	○	○	○	○	
	ZTHD□□□□-EG	0.189-0.228		0.866	○	○	○	○	○	○	○	
	ZTKD□□□□-EG	0.228-0.256		0.866	○	○	○	○	○	○	○	

● Always stock available ○ Produce according to order

Note: (1)The code indicated with * is to be designated based on the edge width and edge radius. The code will be ZTFD03503-EG if the ordered inserts is with an edge width of 0.138inch and an edge radius of 0.118inch.
(2)Edge radius R is based on customers'requiremen.

Single-head grooving and turning inserts for semi-finishing to roughing in difficult-to-machine materials

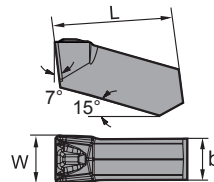
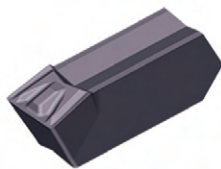

Type	Dimension(inch)				Grade			
	W \pm 0.002	R \pm 0.004	b	L	Coated carbide PVD			Carbide
					YBG105	YBG212	YBG205	YD101
ZIMF304N-SM	0.118	0.016	0.094	0.602	●	●		○
ZIMF404N-SM	0.157	0.016	0.126	0.602	●	●		○
ZIMF504N-SM	0.197	0.016	0.157	0.602	●	●		○
ZIMF604N-SM	0.236	0.016	0.201	0.602	●	●		○

● Always stock available ○ Produce according to order

Precision grooving and turning inserts

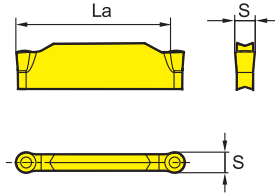

Type	Dimension(inch)			Grade							
				P		M			K		
	$S_{0}^{+0.004}$	$R_{\pm 0.002}$	$L_{a\max}$	YBG202	YBG302	YBG202	YBG302	YD201	YBG302	YD201	YBG102
Double cutting edges	ZRED025-MG	0.098	0.049	0.787	●	●	●	●		●	
	ZRFD03-MG	0.118	0.059	0.787	●	●	●	●		●	
	ZRGD04-MG	0.157	0.079	0.984	●	●	●	●		●	
	ZRHD05-MG	0.197	0.098	0.984	○	●	○	●		●	
	ZRKD06-MG	0.236	0.118	0.984	●	●	●	●		●	

● Always stock available ○ Produce according to order

Profile turning inserts

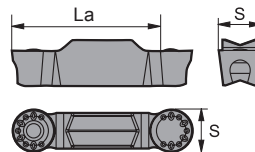

Type	Dimension(inch)		Grade						
			Coated carbide CVD		Coated carbide PVD			Carbide	
	$S_{0}^{+0.004}$	$L_{a\max}$	YBC151	YBC251	YBG105	YBG212	YBG302	YD101	
Double edge	ZRFD03-NM	0.118	0.669			●	●		
	ZRGD04-NM	0.157	0.827			●	●		
	ZRHD05-NM	0.197	0.787			●	●		
	ZRKD06-NM	0.236	0.748			●	●		

● Always stock available ○ Produce according to order

Precision grooving and turning inserts

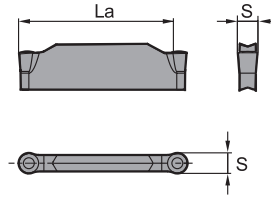

Type	Dimension(inch)			Grade							
				P		M			K		
	$S^{+0.004}_0$	$R\pm 0.002$	$L_{a_{max}}$	YBG202	YBG302	YBG202	YBG302	YD201	YBG302	YD201	YBG102
Double cutting edges	ZRFD03-EG	0.118	0.059	0.787		○		○	○	○	
	ZRGD04-EG	0.157	0.079	0.984		○		○	○	○	
	ZRHD05-EG	0.197	0.098	0.984		○		○	○	○	
	ZRKD06-EG	0.236	0.118	0.984		○		○	○	○	

● Always stock available ○ Produce according to order

B

Single-head grooving and turning inserts for precision profiling in difficult-to-machine materials

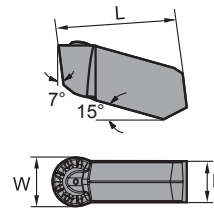

Type	Dimension(inch)			Grade		
				Coated carbide PVD		Carbide
	$W\pm 0.001$	b	L	YBG105	YBG212	YD101
ZIGQ3N-NF	0.118	0.094	0.602	●	●	
ZIGQ4N-NF	0.157	0.126	0.602	●	●	
ZIGQ5N-NF	0.197	0.157	0.602	●	●	
ZIGQ6N-NF	0.236	0.200	0.602	●	●	

● Always stock available ○ Produce according to order

External and Face Cutting tools code key

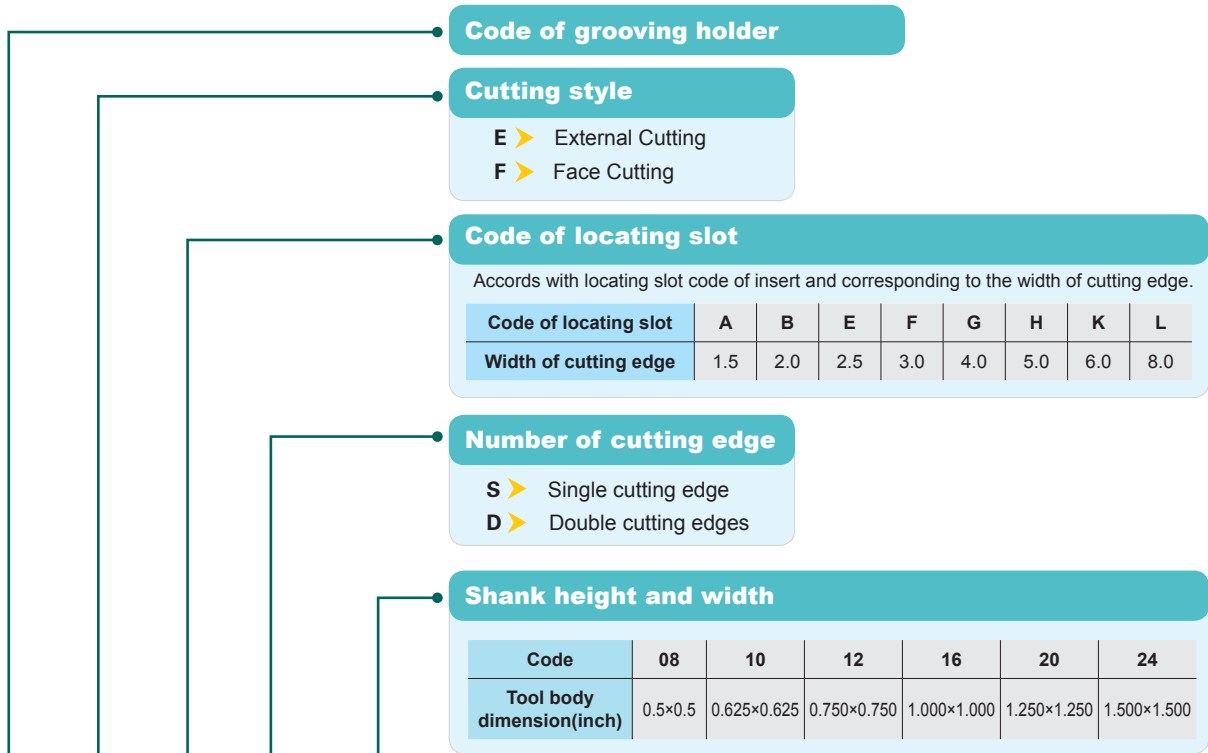

Q E G D 12 - 04 C R 22

Q F G D 16 - 04 D R 22 - 64 H

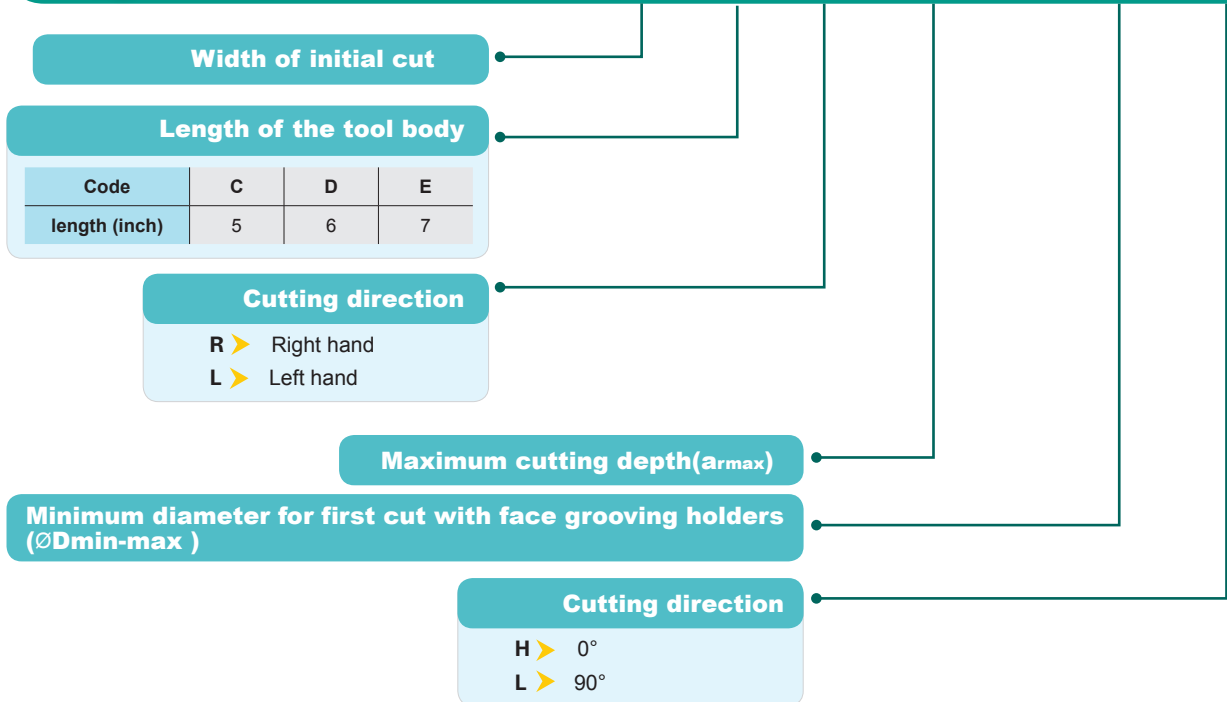

External parting, grooving and turning tools

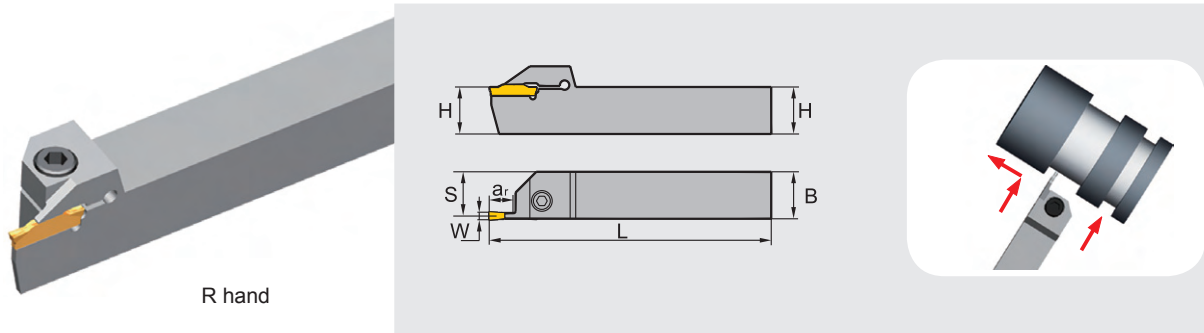

Type		Dimension(inch)					Applicable inserts	Screw	Wrench
		H×B	L	S	W	a _{rmax}			
QEAD	08-015CR/L07	0.500×0.500	5	0.478	0.059	0.276	Z□AD015□□	GB70-85-M5×16	WH40L
	08-015CR/L12	0.500×0.500	5	0.478	0.059	0.472	Z□AD015□□		
	10-015CR/L07	0.625×0.625	5	0.636	0.059	0.276	Z□AD015□□		
	10-015CR/L12	0.625×0.625	5	0.636	0.059	0.472	Z□AD015□□		
	12-015CR/L07	0.750×0.750	5	0.793	0.059	0.276	Z□AD015□□		
	12-015CR/L12	0.750×0.750	5	0.793	0.059	0.472	Z□AD015□□		
QEBD	08-02CR/L07	0.500×0.500	5	0.479	0.079	0.276	Z□BD02□□	GB70-85-M5×16	WH40L
	08-02CR/L10	0.500×0.500	5	0.479	0.079	0.394	Z□BD02□□		
	08-02CR/L14	0.500×0.500	5	0.479	0.079	0.551	Z□BD02□□		
	10-02CR/L07	0.625×0.625	5	0.636	0.079	0.276	Z□BD02□□		
	10-02CR/L10	0.625×0.625	5	0.636	0.079	0.394	Z□BD02□□		
	10-02CR/L14	0.625×0.625	5	0.636	0.079	0.551	Z□BD02□□		
	12-02CR/L07	0.750×0.750	5	0.794	0.079	0.276	Z□BD02□□	GB70-85-M6×20	WH50L
	12-02CR/L10	0.750×0.750	5	0.794	0.079	0.394	Z□BD02□□		
	12-02CR/L14	0.750×0.750	5	0.794	0.079	0.551	Z□BD02□□		
	16-02DR/L07	1.000×1.000	6	0.991	0.079	0.276	Z□BD02□□		
	16-02DR/L10	1.000×1.000	6	0.991	0.079	0.394	Z□BD02□□		
	16-02DR/L14	1.000×1.000	6	0.991	0.079	0.551	Z□BD02□□		
QEED	10-025CR/L10	0.625×0.625	5	0.591	0.098	0.394	Z□ED025□□	GB70-85-M5×20	WH40L
	10-025CR/L17	0.625×0.625	5	0.591	0.098	0.669	Z□ED025□□		
	12-025CR/L10	0.750×0.750	5	0.748	0.098	0.394	Z□ED025□□	GB70-85-M6×20	WH50L
	12-025CR/L17	0.750×0.750	5	0.748	0.098	0.669	Z□ED025□□		
	16-025DR/L10	1.000×1.000	6	0.945	0.098	0.394	Z□ED025□□		
	16-025DR/L17	1.000×1.000	6	0.945	0.098	0.669	Z□ED025□□		
QEFD	10-03CR/L10	0.625×0.625	5	0.583	0.118	0.394	Z□FD03□□	GB70-85-M5×20	WH40L
	10-03CR/L17	0.625×0.625	5	0.583	0.118	0.669	Z□FD03□□		
	12-03CR/L10	0.750×0.750	5	0.740	0.118	0.394	Z□FD03□□	GB70-85-M6×20	WH50L
	12-03CR/L17	0.750×0.750	5	0.740	0.118	0.669	Z□FD03□□		
	16-03DR/L10	1.000×1.000	6	0.937	0.118	0.394	Z□FD03□□		
	16-03DR/L17	1.000×1.000	6	0.937	0.118	0.669	Z□FD03□□		
QEGD	12-04CR/L13	0.750×0.750	5	0.728	0.157	0.512	Z□GD04□□	GB70-85-M6×20	WH50L
	12-04CR/L22	0.750×0.750	5	0.728	0.157	0.866	Z□GD04□□		
	16-04DR/L13	1.000×1.000	6	0.925	0.157	0.512	Z□GD04□□		

© Parting, grooving, turning, profiling inserts are adaptable to the tools

External parting, grooving and turning tools

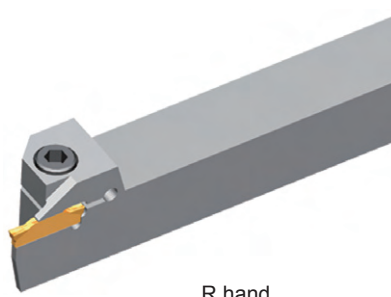

R hand

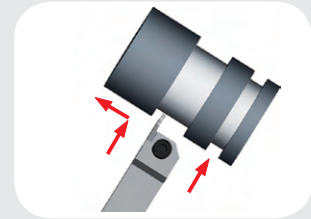
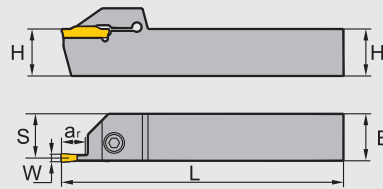

Type		Dimension(inch)					Applicable inserts	Screw	Wrench
		H×B	L	S	W	a _{max}			
QEGD	16-04DR/L22	1.000×1.000	6	0.925	0.157	0.866		 GB70-85-M6×20	 WH50L
	20-04ER/L13	1.250×1.250	7	1.201	0.157	0.512			
	20-04ER/L22	1.250×1.250	7	1.201	0.157	0.866			
QEHD	16-05DR/L13	1.000×1.000	6	0.906	0.197	0.512		 GB70-85-M6×20	 WH50L
	16-05DR/L22	1.000×1.000	6	0.906	0.197	0.866			
QEHS	16-05DN30	1.000×1.000	6	0.492	0.197	1.181		 GB70-85-M6×20	 WH50L
QEHD	20-05ER/L13	1.250×1.250	7	1.181	0.197	0.512			
QEHS	20-05ER/L22	1.250×1.250	7	1.181	0.197	0.866		 GB70-85-M6×20	 WH50L
QEKS	20-05EN30	1.250×1.250	7	0.630	0.197	1.181			
QEKD	16-06DR/L13	1.000×1.000	6	0.890	0.236	0.512		 GB70-85-M6×20	 WH50L
	16-06DR/L22	1.000×1.000	6	0.890	0.236	0.866			
QEKD	16-06DN30	1.000×1.000	6	0.492	0.236	1.181		 GB70-85-M6×20	 WH50L
QEKD	20-06ER/L13	1.250×1.250	7	1.165	0.236	0.512			
QEKD	20-06ER/L22	1.250×1.250	7	1.165	0.236	0.866		 GB70-85-M6×20	 WH50L
QEKD	20-06EN30	1.250×1.250	7	0.630	0.236	1.181			
QELD	16-08DR/L16	1.000×1.000	6	0.886	0.315	0.630		 GB70-85-M6×20	 WH50L
	16-08DR/L25	1.000×1.000	6	0.886	0.315	0.984			
	20-08ER/L28	1.250×1.250	7	1.142	0.315	1.102			

© Parting, grooving, turning, profiling inserts are adaptable to the tools

External parting, grooving and turning tools

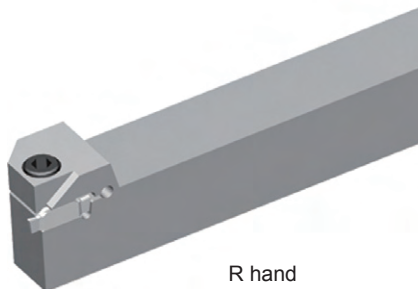

R hand

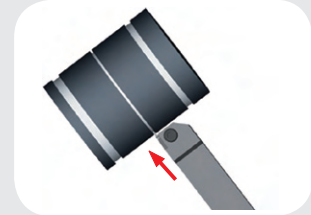
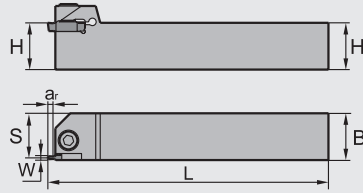

Type		Dimension(inch)					Applicable inserts	Screw	Wrench
		H×B	L	S	W	a _{max}			
QECD	10-XCR/L025	0.625×0.625	5	0.581	0.039~0.256 (Made to order)	0.098	ZTCD□□□□□-EG	GB70-85-M5×20	WH40L
	12-XCR/L025	0.750×0.750	5	0.738					
	16-XCR/L025	1.000×1.000	6	0.935					

B

Precision grooving and turning tools

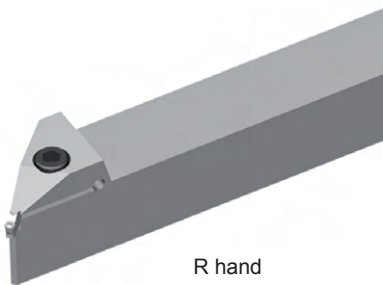

R hand

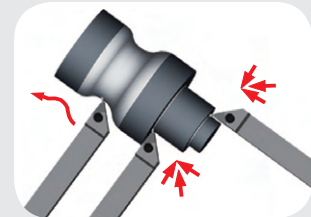
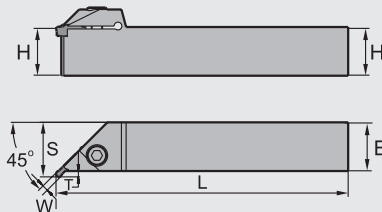

Type		Dimension(inch)					Applicable inserts	Screw	Wrench
		H×B	L	S	W	a _{max}			
QXFD	12-03CR/L03	0.750×0.750	5	0.906	0.118	0.118	ZR(T)FD03-EG ZR(T)FD03-MG	GB70-85-M6×20	WH50L
	16-03DR/L03	1.000×1.000	6	1.102					
	20-03ER/L03	1.250×1.250	7	1.378					
QXGD	12-04CR/L03	0.750×0.750	5	0.906	0.157	0.118	ZR(T)GD04-EG ZR(T)GD04-MG	GB70-85-M6×20	WH50L
	16-04DR/L03	1.000×1.000	6	1.102					
	20-04ER/L03	1.250×1.250	7	1.378					
QXHD	12-05CR/L04	0.750×0.750	5	0.945	0.197	0.157	ZR(T)HD05-EG ZR(T)HD05-MG	GB70-85-M6×20	WH50L
	16-05DR/L04	1.000×1.000	6	1.142					
	20-05ER/L04	1.250×1.250	7	1.417					
QXKD	12-06CR/L04	0.750×0.750	5	0.945	0.236	0.157	ZR(T)KD06-EG ZR(T)KD06-MG	GB70-85-M6×20	WH50L
	16-06DR/L04	1.000×1.000	6	1.142					
	20-06ER/L04	1.250×1.250	7	1.417					

Parting blade holder code key

Code of parting blade holder

Number of cutting edge

- S > Single cutting edge
- D > Double cutting edges

Size of holders

code of holders	0750	1000	1250
Size of holders (inch)	0.750	1.000	1.250

Height of blade

QZ S 1250 32

Parting Blade Holders

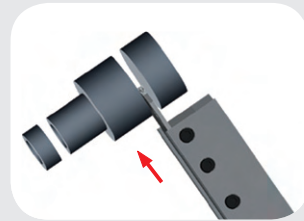
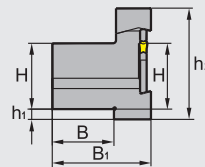

Type	Dimension(inch)						Clamps	Screw	Wrench
	L	H	h ₁	h ₂	B	B ₁			
QZS0750-26	3.386	0.750	0.394	1.835	0.748	1.496	QZC26	GB70-85-M6×20	WH50L
QZS1000-26	3.386	1.000	0.197	1.835	0.906	1.654	QZC26		
QZS1250-26	3.386	1.250	0.118	2.031	1.181	1.890	QZC26		
QZS0750-32	4.331	0.750	0.512	1.969	0.748	1.496	QZC32		
QZS1000-32	4.331	1.000	0.315	1.969	0.906	1.654	QZC32		
QZS1250-32	4.331	0.750	0.197	2.126	1.181	1.890	QZC32		

External Parting Blade

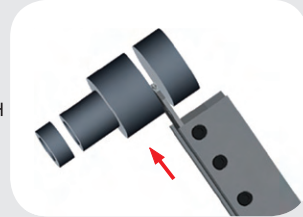
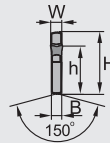
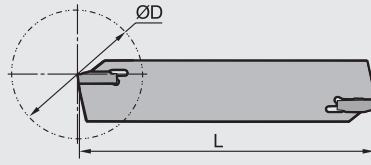

Type	Dimension(inch)						Inserts	Wrench
	L	H	h	B	W	ØDmax		
QEES26N	4.331	1.024	0.748	0.079	0.098	2.362	ZPES02502-MG	W50RL
QEFS26N	4.331	1.024	0.748	0.094	0.118	2.362	ZPFS0302-MG	
QEGS26N	4.331	1.024	0.748	0.126	0.157	2.756	ZPGS0402-MG	
QEHS26N	4.331	1.024	0.748	0.157	0.197	2.756	ZPHS0503-MG	
QEKs26N	4.331	1.024	0.748	0.197	0.236	2.756	ZPKS0604-MG	
QEES32N	5.906	1.260	0.969	0.079	0.098	3.937	ZPES02502-MG	
QEFS32N	5.906	1.260	0.969	0.094	0.118	3.937	ZPFS0302-MG	
QEGS32N	5.906	1.260	0.969	0.126	0.157	4.724	ZPGS0402-MG	
QEHS32N	5.906	1.260	0.969	0.157	0.197	4.724	ZPHS0503-MG	
QEKs32N	5.906	1.260	0.969	0.197	0.236	4.724	ZPKS0604-MG	

B

Face Grooving and Turning Tools



L hand

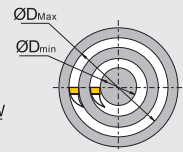
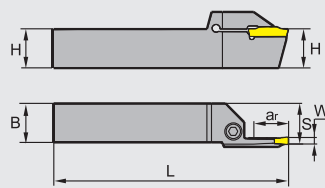

Diameter range of the initial process



Type	Dimension(inch)						Inserts	Screw	Wrench
	HxB	L	S	W	ar	ØD (min-max)			
QFFD16-03DR/L10-48H	1.000×1.000	6	1.024	0.118	0.394	1.890-2.598	ZTFD0303-MG	GB70-85-M6×20	WH50L
QFFD16-03DR/L17-48H	1.000×1.000	6	1.024	0.118	0.669	1.890-2.598			
QFFD16-03DR/L10-60H	1.000×1.000	6	1.024	0.118	0.394	2.362-3.150			
QFFD16-03DR/L17-60H	1.000×1.000	6	1.024	0.118	0.669	2.362-3.150			
QFFD16-03DR/L10-74H	1.000×1.000	6	1.024	0.118	0.394	2.913-4.331			
QFFD16-03DR/L17-74H	1.000×1.000	6	1.024	0.118	0.669	2.913-4.331			

Face Grooving and Turning Tools

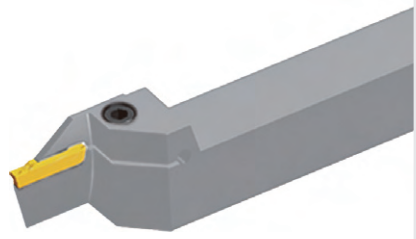

L hand

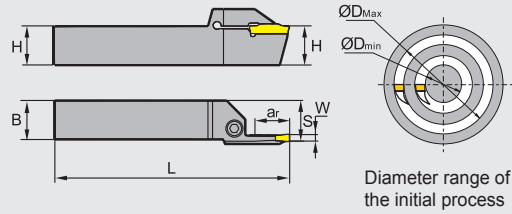

B

Type	Dimension(inch)						Inserts	Screw	Wrench
	H×B	L	S	W	ar	ØD (min-max)			
QFFD16-03DR/L10-100H	1.000×1.000	6	1.024	0.118	0.394	3.937-5.906	ZTFD0303-MG	GB70-85-M6×20	WH50L
QFFD16-03DR/L17-100H	1.000×1.000	6	1.024	0.118	0.669	3.937-5.906			
QFGD16-04DR/L13-52H	1.000×1.000	6	1.024	0.157	0.512	2.047-2.835	ZTGD0404-MG		
QFGD16-04DR/L22-52H	1.000×1.000	6	1.024	0.157	0.866	2.047-2.835			
QFGD16-04DR/L13-64H	1.000×1.000	6	1.024	0.157	0.512	2.520-3.937			
QFGD16-04DR/L22-64H	1.000×1.000	6	1.024	0.157	0.866	2.520-3.937			
QFGD16-04DR/L13-90H	1.000×1.000	6	1.024	0.157	0.512	3.543-5.512			
QFGD16-04DR/L22-90H	1.000×1.000	6	1.024	0.157	0.866	3.543-5.512			
QFGD16-04DR/L13-130H	1.000×1.000	6	1.024	0.157	0.512	5.118-9.055			
QFGD16-04DR/L22-130H	1.000×1.000	6	1.024	0.157	0.866	5.118-9.055			
QFHD16-05DR/L13-58H	1.000×1.000	6	1.024	0.197	0.512	2.238-3.780	ZTHD0504-MG		
QFHD16-05DR/L22-58H	1.000×1.000	6	1.024	0.197	0.866	2.238-3.780			
QFHD16-05DR/L13-86H	1.000×1.000	6	1.024	0.197	0.512	3.386-5.512			
QFHD16-05DR/L22-86H	1.000×1.000	6	1.024	0.197	0.866	3.386-5.512			
QFHD16-05DR/L13-130H	1.000×1.000	6	1.024	0.197	0.512	5.118-7.874			
QFHD16-05DR/L22-130H	1.000×1.000	6	1.024	0.197	0.866	5.118-7.874			
QFHD16-05DR/L13-185H	1.000×1.000	6	1.024	0.197	0.512	7.283-15.748			
QFHD16-05DR/L22-185H	1.000×1.000	6	1.024	0.197	0.866	7.283-15.748			
QFHS16-05DR/L30-185H	1.000×1.000	6	1.024	0.197	1.181	7.283-15.748	ZTHS0504-MG		
QFKD16-06DR/L13-60H	1.000×1.000	6	1.024	0.236	0.512	2.362-3.937	ZTKD0608-MG		
QFKD16-06DR/L22-60H	1.000×1.000	6	1.024	0.236	0.866	2.362-3.937			
QFKD16-06DR/L13-88H	1.000×1.000	6	1.024	0.236	0.512	3.465-7.087			
QFKD16-06DR/L22-88H	1.000×1.000	6	1.024	0.236	0.866	3.465-7.087			
QFKD16-06DR/L13-160H	1.000×1.000	6	1.024	0.236	0.512	6.299-15.748			
QFKD16-06DR/L22-160H	1.000×1.000	6	1.024	0.236	0.866	6.299-15.748			
QFKS16-06DR/L30-160H	1.000×1.000	6	1.024	0.236	1.181	6.299-15.748	ZTKS0608-MG		
QFLD16-08DR/L25-75H	1.000×1.000	6	1.063	0.315	0.984	2.953-5.906	ZTLD0808-MM	GB70-85-M8×30	WH60L
QFLD16-08DR/L25-140H	1.000×1.000	6	1.063	0.315	0.984	5.512-15.748			
QFLD20-08ER/L28-140H	1.250×1.250	7	1.181	0.315	1.102	5.512-15.748			

Face Grooving and Turning Tools

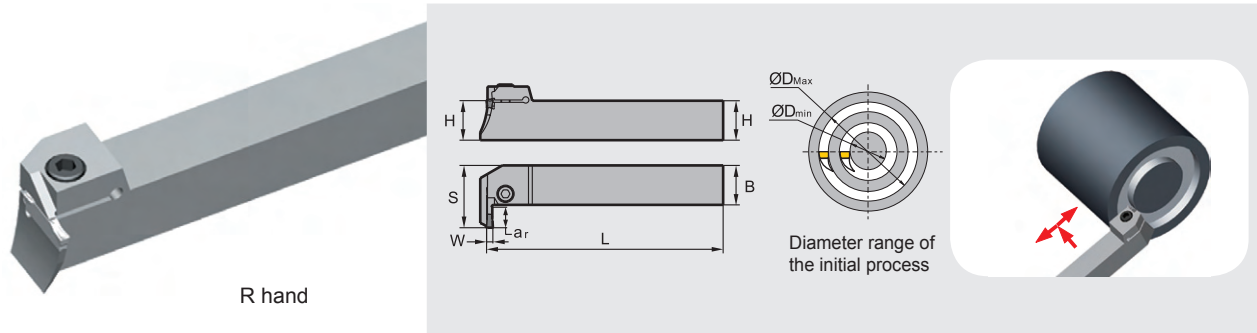

Type	Dimension(inch)						Inserts	Screw	Wrench
	H×B	L	S	W	ar	ØD (min-max)			
QFFD16-03DR/L10-48L	1.000×1.000	6	1.024	0.118	0.394	1.890-2.598	ZTFD0303-MG	GB70-85-M6×20	WH50L
QFFD16-03DR/L17-48L	1.000×1.000	6	1.024	0.118	0.669	1.890-2.598			
QFFD16-03DR/L10-60L	1.000×1.000	6	1.024	0.118	0.394	2.362-3.150			
QFFD16-03DR/L17-60L	1.000×1.000	6	1.024	0.118	0.669	2.362-3.150			
QFFD16-03DR/L10-74L	1.000×1.000	6	1.024	0.118	0.394	2.913-4.331			
QFFD16-03DR/L17-74L	1.000×1.000	6	1.024	0.118	0.669	2.913-4.331			
QFFD16-03DR/L10-100L	1.000×1.000	6	1.024	0.118	0.394	3.937-5.906			
QFFD16-03DR/L17-100L	1.000×1.000	6	1.024	0.118	0.669	3.937-5.906			
QFGD16-04DR/L13-52L	1.000×1.000	6	1.024	0.157	0.512	2.047-2.835	ZTGD0404-MG		
QFGD16-04DR/L22-52L	1.000×1.000	6	1.024	0.157	0.866	2.047-2.835			
QFGD16-04DR/L13-64L	1.000×1.000	6	1.024	0.157	0.512	2.520-3.937			
QFGD16-04DR/L22-64L	1.000×1.000	6	1.024	0.157	0.866	2.520-3.937			
QFGD16-04DR/L13-90L	1.000×1.000	6	1.024	0.157	0.512	3.543-5.512			
QFGD16-04DR/L22-90L	1.000×1.000	6	1.024	0.157	0.866	3.543-5.512			
QFGD16-04DR/L13-130L	1.000×1.000	6	1.024	0.157	0.512	5.118-9.055			
QFGD16-04DR/L22-130L	1.000×1.000	6	1.024	0.157	0.866	5.118-9.055			
QFHD16-05DR/L13-58L	1.000×1.000	6	1.024	0.197	0.512	2.238-3.780	ZTHD0504-MG		
QFHD16-05DR/L22-58L	1.000×1.000	6	1.024	0.197	0.866	2.238-3.780			
QFHD16-05DR/L13-86L	1.000×1.000	6	1.024	0.197	0.512	3.386-5.512			
QFHD16-05DR/L22-86L	1.000×1.000	6	1.024	0.197	0.866	3.386-5.512			
QFHD16-05DR/L13-130L	1.000×1.000	6	1.024	0.197	0.512	5.118-7.874			
QFHD16-05DR/L22-130L	1.000×1.000	6	1.024	0.197	0.866	5.118-7.874			
QFHD16-05DR/L13-185L	1.000×1.000	6	1.024	0.197	0.512	7.283-15.748			
QFHD16-05DR/L22-185L	1.000×1.000	6	1.024	0.197	0.866	7.283-15.748			
QFHS16-05DR/L30-185L	1.000×1.000	6	1.024	0.197	1.181	7.283-15.748	ZTHS0504-MG		
QFKD16-06DR/L13-60L	1.000×1.000	6	1.024	0.236	0.512	2.362-3.937	ZTKD0608-MG		
QFKD16-06DR/L22-60L	1.000×1.000	6	1.024	0.236	0.866	2.362-3.937			
QFKD16-06DR/L13-88L	1.000×1.000	6	1.024	0.236	0.512	3.465-7.087			
QFKD16-06DR/L22-88L	1.000×1.000	6	1.024	0.236	0.866	3.465-7.087			
QFKD16-06DR/L13-160L	1.000×1.000	6	1.024	0.236	0.512	6.299-15.748			
QFKD16-06DR/L22-160L	1.000×1.000	6	1.024	0.236	0.866	6.299-15.748			
QFKS16-06DR/L30-160L	1.000×1.000	6	1.024	0.236	1.181	6.299-15.748	ZTKS0608-MG		

Internal cutting tools code key

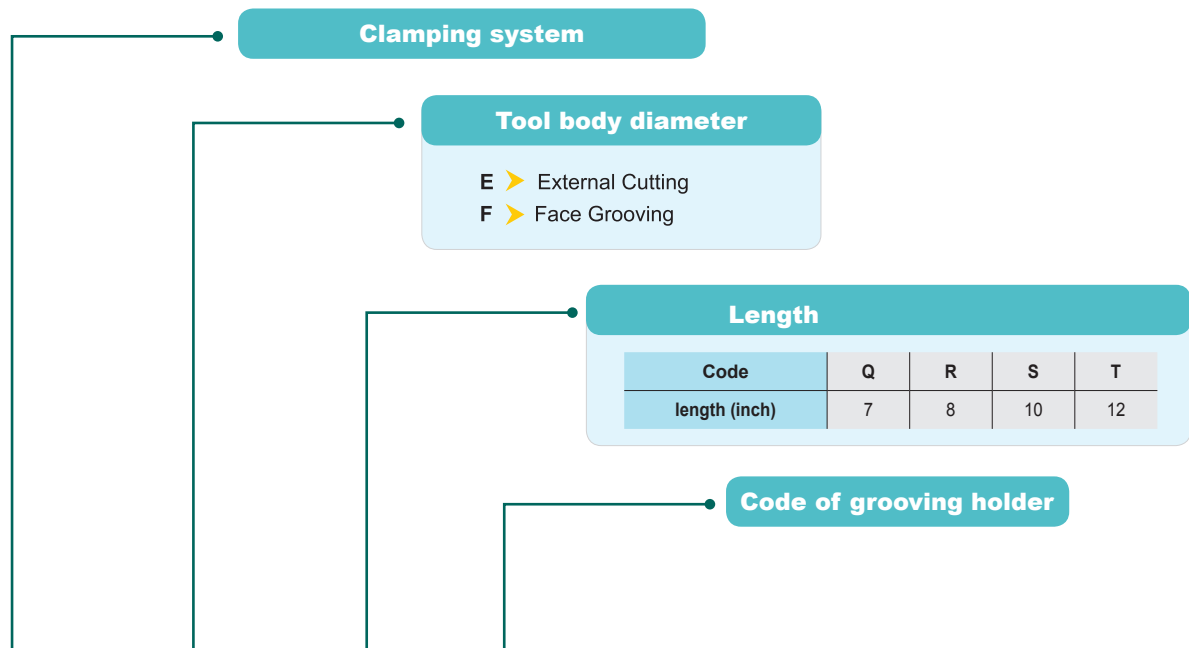

C 1250 S - Q G D R 11 14

Code of locating slot

Accords with locating slot code of insert and corresponding to the width of cutting edge.

Code of locating slot	E	F	G	H	K
Width of cutting edge(inch)	0.098	0.118	0.157	0.197	0.236

Number of cutting edge

- S > Single cutting edge
- D > Double cutting edges

Cutting direction

- R > Right hand
- L > Left hand

Maximum cutting depth(a_{max})

Minimum machining diameter($\varnothing D$)

Internal grooving and turning tools

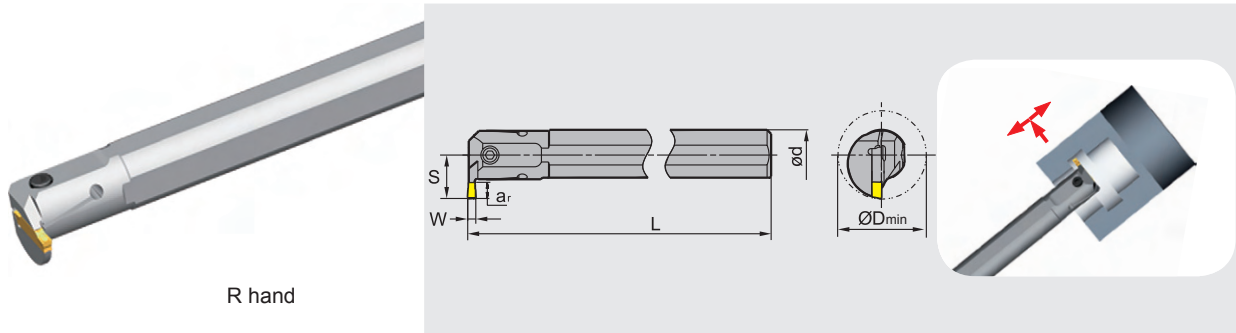

Type	Dimension(inch)						Applicable inserts	Screw	Wrench
	Ød	L	S	W	a _{max}	ØD			
C0750Q-QEDR/L05-27	0.750	7	0.598	0.098	0.197	1.063	ZTED025-□□ ZRED□□□□□-□□	GB70-85-M4×12	WH30L
C1000R-QEDR/L07-33	1.000	8	0.799	0.098	0.276	1.299		GB70-85-M5×16	WH40L
C1250S-QEDR/L09-42	1.250	10	0.996	0.098	0.354	1.654		GB70-85-M5×20	
C0750Q-QFDR/L05-27	0.750	7	0.598	0.118	0.197	1.063	ZTFD□□□□□-□□ ZRFD□□□□□-□□	GB70-85-M4×12	WH30L
C1000R-QFDR/L07-33	1.000	8	0.799	0.118	0.276	1.299		GB70-85-M5×16	WH40L
C1250S-QFDR/L09-42	1.250	10	0.966	0.118	0.354	1.654		GB70-85-M5×20	
C1000R-QGDR/L08-35	1.000	8	0.846	0.157	0.315	1.378	ZTGD□□□□□-□□ ZRGD□□□□□-□□	GB70-85-M5×16	WH40L
C1250S-QGDR/L11-44	1.250	10	1.083	0.157	0.433	1.732		GB70-85-M6×20	WH50L
C1500T-QGDR/L13-54	1.500	12	1.319	0.157	0.512	2.216		GB70-85-M6×20	
C1000R-QHDR/L08-35	1.000	8	0.846	0.197	0.315	1.378	ZTHD□□□□□-□□ ZRHDR□□□□□-□□	GB70-85-M5×16	WH40L
C1250S-QHDR/L11-44	1.250	10	1.083	0.197	0.433	1.732		GB70-85-M6×20	WH50L
C1500T-QHDR/L13-54	1.500	12	1.319	0.197	0.512	2.126		GB70-85-M6×20	
C1000R-QKDR/L08-35	1.000	8	0.846	0.236	0.315	1.378	ZTKD□□□□□-□□ ZRKD□□□□□-□□	GB70-85-M5×16	WH40L
C1250S-QKDR/L11-44	1.250	10	1.083	0.236	0.433	1.732		GB70-85-M6×20	WH50L
C1500T-QKDR/L13-54	1.500	12	1.319	0.236	0.512	2.126		GB70-85-M6×20	

B

● Recommended cutting parameters for parting and grooving tools

Insert size	Recommended feed rate(inch/r)			
	Parting	Grooving	Turning	Profiling
Insert width(inch)				
0.098	0.002-0.006	0.002-0.006	0.002-0.006	0.002-0.006
0.118	0.002-0.006	0.002-0.006	0.003-0.006	0.004-0.008
0.157	0.002-0.008	0.002-0.008	0.003-0.010	0.004-0.008
0.197	0.003-0.008	0.003-0.009	0.004-0.010	0.006-0.012
0.236	0.004-0.012	0.003-0.010	0.004-0.012	0.006-0.012

Workpiece material	Hardness	YBG302	YBG202 YBG205	YBG105	YBG212	YBC151	YBC251	YD101	YD201	YBG102	YC10	YC40
P Carbon steel	125 ≤ HB ≤ 170	100-850	500-1000			450-1000	500-900				400-1000	360-850
	Low alloy steel	180 ≤ HB ≤ 275	260-600	360-650		300-800	360-650				300-650	230-550
	High alloy steel	180 ≤ HB ≤ 325	260-500	360-600		300-700	360-600				300-600	230-500
	Cast steel	180 ≤ HB ≤ 250	240-450	300-550			260-500	300-550				260-550
M Ferrite, Martensite	200 ≤ HB ≤ 300	230-550	300-650				300-650				260-650	200-550
	Austenite	180 ≤ HB ≤ 300	260-650	360-700			360-700				300-700	230-650
K Malleable cast iron	130 ≤ HB ≤ 230	300-650	400-700						300-500			
	Grey cast iron	180 ≤ HB ≤ 220	300-550	400-650					260-450			
	Nodular cast iron	160 ≤ HB ≤ 250	260-500	360-600					200-450			
N Al alloy	--							650-1300				
S Hightemperature alloy	≤ 400			130-230	60-160			60-160		100-200		

The cutting parameters recommended are suitable for wet machining.

Advice: internal machining and face machining, The cutting speed should be reduced by 30%-40%.

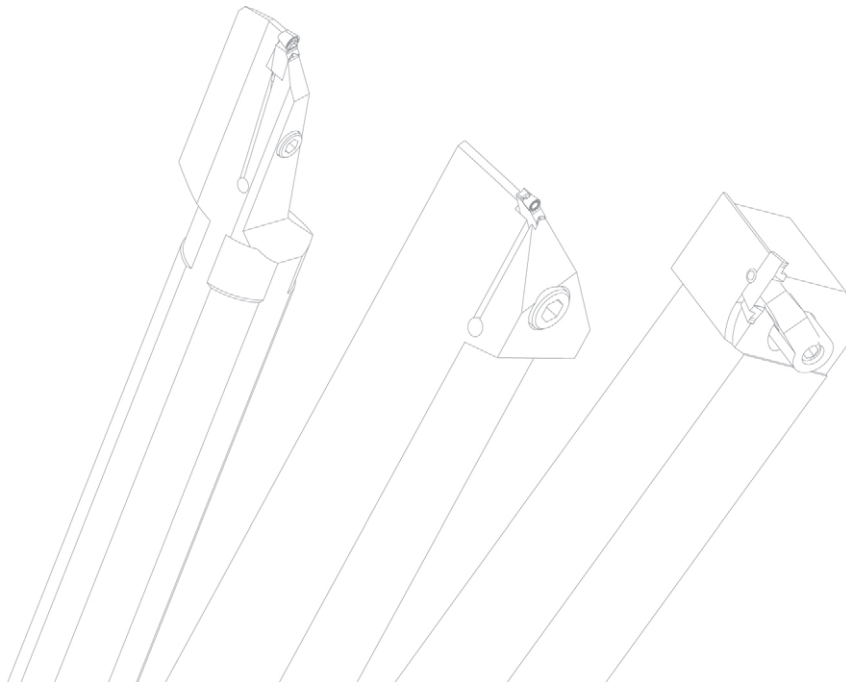

Centerline Parting and Grooving Tools

- No matter which parting or grooving tools are selected, the best performance is realized when insert is positioned at the centerline of workpiece. This also reduces vibrations during machining.
- The insert cutting edge and centerline of workpiece should be within $\pm .004$. For parting and grooving workpieces with small diameter, this especially true to reduce cutting force, reduce burring, and improve tool life.

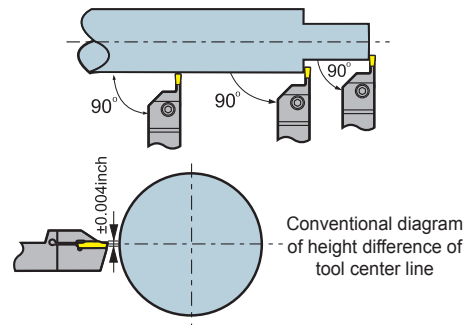

Parting

- When the insert is approaching center of workpiece, the cutting speed should be reduced by 30%, which is good for improving tool life and surface quality.
- Whenever possible, shorten the overhang of the tool as much as possible to ensure good stability.

External grooving, turning, and profiling

- In-Feed Sequence: When Cutting Depth >0.020 ", Radial in-feed (Max. Cutting depth can be $3/4$ of the insert edge width) → Radial out-feed about 0.004 " → Axial in feed → Flank out-feed → Axial in feed → Radial machining to required depth.
- When finishing, use sequence as shown in the diagram to reduce vibration.

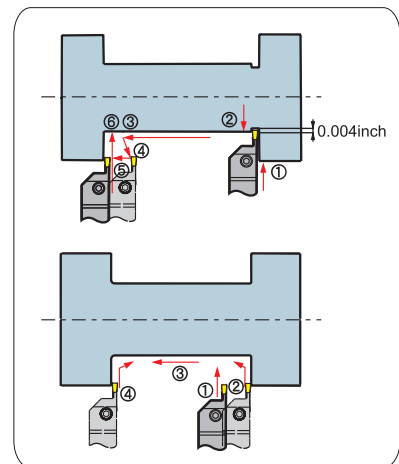

Face grooving and turning

- Finishing Machining (Multi-slot Cutting)
First cut inward from max diameter of face opening, then reposition insert, as shown in diagram (1)
- Face groove turning
Axial turning depth should not be more than $3/4$ of the cutting edge width.
When slot width is larger than slot depth, turn with multiple passes, as shown in the picture (2)
- Finishing Machining
First finish machine bottom and external diameter fringe, then finish the internal diameter to required size, as shown in the picture (3)

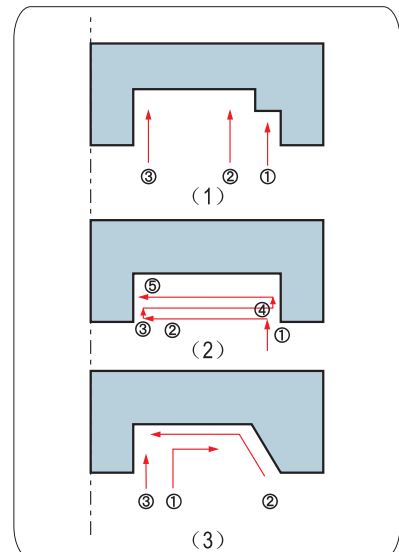

Internal grooving and turning

- For good chip flow, follow the machining sequence in the diagram shown. Infeed from the deepest end of the hole and then back turn.

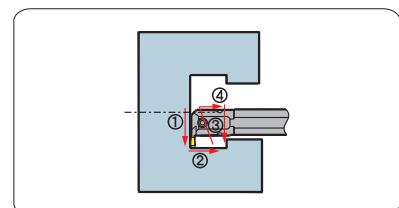

B

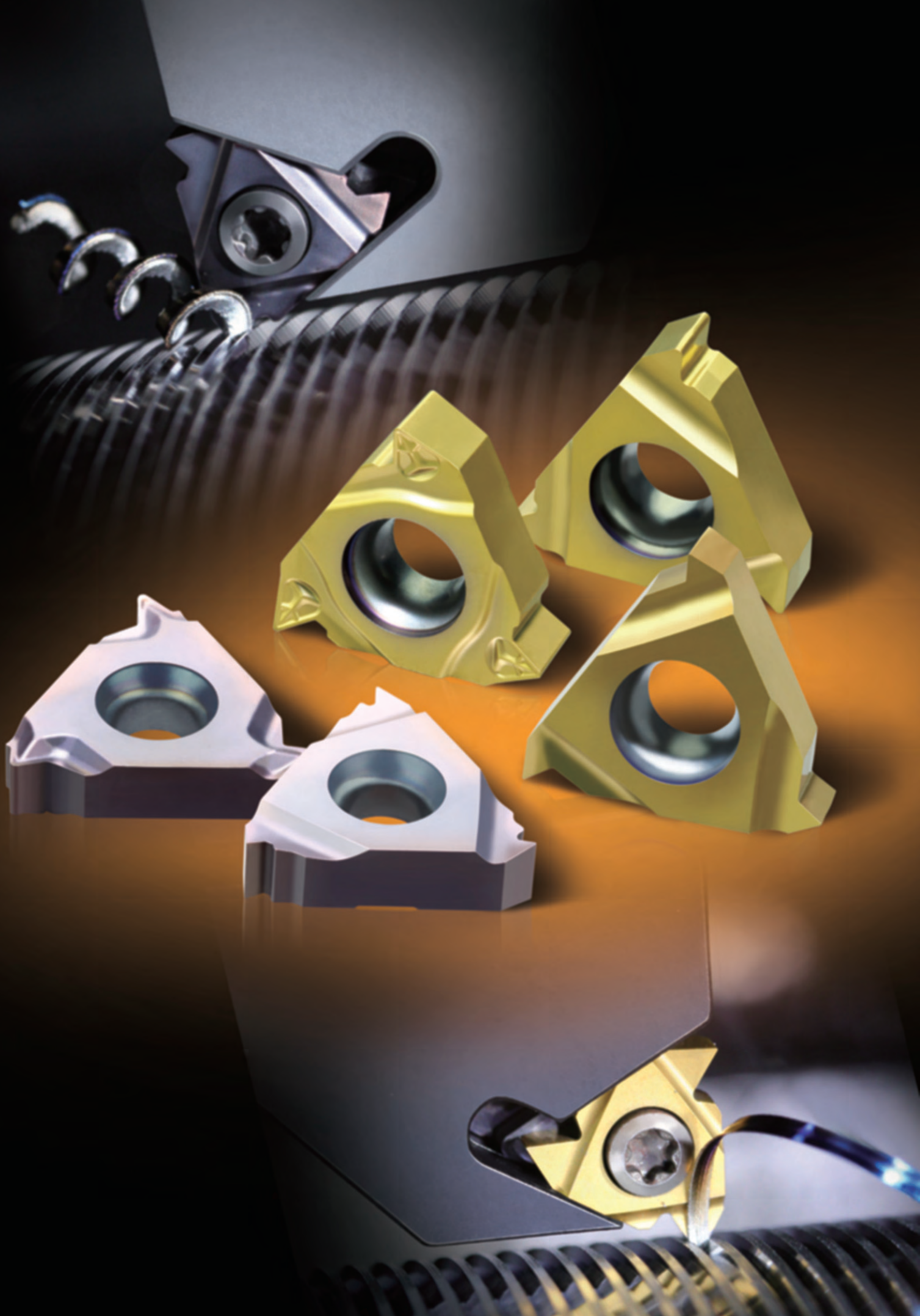







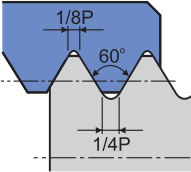
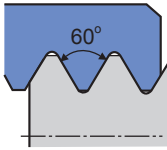
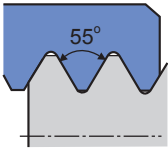

Turning

THREADING TOOLS

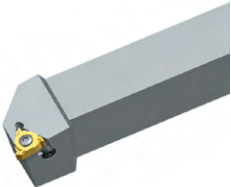
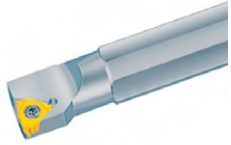

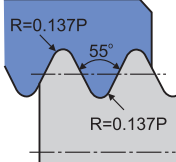
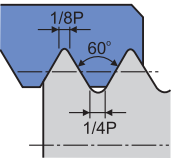
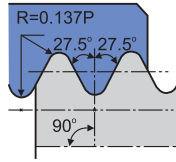
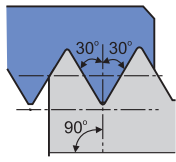

Threading tools overview	P146-151
Code key for threading inserts	P153
ISO metric threading insert	P154-155
General pitch threading insert without end	P156
Whitworth thread insert	P157
Unified thread insert with a shoulder	P158
British standard taper pipe thread insert	P159
NPT American standard taper pipe thread	P160
UNJ American standard aerospace and aviation threads	P161
American ACME	P162
American STUB-ACME (Short tooth threads)	P163
API 60°	P164
API Round	P165
API Buttress casing	P166
ISO metric threading insert (Thin type)	P167-168
General pitch threading insert without end (Thin type)	P169
Whitworth thread insert (Thin type)	P170
Unified thread insert with a shoulder (Thin type)	P171
British standard taper pipe thread insert (Thin type)	P172
NPT American standard taper pipe thread insert (Thin type)	P173
External threading tools code key	P174
Internal threading tools code key	P175
External threading tools	P176-178
Internal threading tools	P177-178
Recommended cutting parameters list	P181
Common problem in threading and solutions	P183



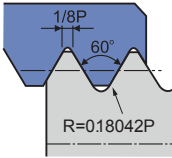
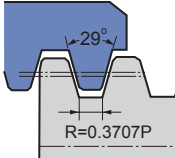
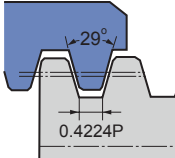

● Threading tools overview

Applications		For general		
Cutline				
Thread name		ISO metric thread With end	General pitch thread Without end	General pitch thread Without end
Profile		GM	60	55
Shape of insert (length: 0.43, 0.63, 0.87inch)		As picture shows R type external threads  P154	As picture shows R type external threads  P156	As picture shows R type external threads  P156
Tool holder	Pitch			
	Dimensions (inch) (H×W×L) (Dia×L×Min. dia)	Pitch/Inch	Pitch/inch(teeth/Inch)	Pitch/inch(teeth/Inch)
External thread	 P176	.625 x .625 x 4 .750 x .750 x 5 1.00 x 1.00 x 6 1.25 x 1.35 x 7	0.039~0.236	0.02~0.197 (5~48)
Internal thread	 P177	.625 x 6 x .630 .750 x 7 x 1.00 1.00 x 6 x 1.25 1.25 x 8 x 1.50 1.5 x 12 x 2.00 2.00 x 14 x 2.50	0.039~0.236	0.02~0.197 (5~48)

Applications		For general	For aerospace and aviation industries	Pipe thread for heater, gas and water	For connecting between pipe fitting and coupling of gas and water
Cutline					
Thread name		Whitworth thread	Unified thread (American standard threads)	British standard taper pipe threads	American standard taper pipe threads
Profile		W	UN	BSPT	NPT
Shape of insert (length: 0.43, 0.63, 0.87 inch)		As picture shows R type external threads  P157	As picture shows R type external threads  P158	As picture shows R type external threads  P159	As picture shows R type external threads  P160
Dimensions (inch) (H×W×L) (Dia×L×Min. dia)		Teeth/Inch	Teeth/Inch	Teeth/Inch	Teeth/Inch
External thread	.625 x .625 x 4 .750 x .750 x 5 1.00 x 1.00 x 6 1.25 x 1.35 x 7	8~16	8~20	11~28	8~27
	.625 x 6 x .630 .750 x 7 x 1.00 1.00 x 6 x 1.25 1.25 x 8 x 1.50 1.5 x 12 x 2.00 2.00 x 14 x 2.50	8~16	8~20	11~28	8~27

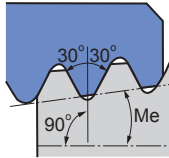
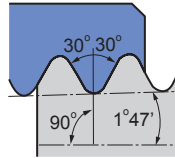
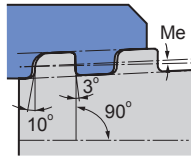

Applications		For aerospace and aviation industries	Trapezoidal screw mandrel for transmission		
Cutline					
Thread name		UNJ (American standard aerospace and aviation threads)	American ACME	Short tooth threads	
Profile		60	ACME	STUB —ACME	
Shape of insert (length: 0.43, 0.63, 0.87inch)		As picture shows R type external threads  P161	As picture shows R type external threads  P162	As picture shows R type external threads  P163	
Tool holder	Pitch	Dimensions (inch) (H×W×L) (Dia×L×Min. dia)	Teeth/Inch	Teeth/Inch	Teeth/Inch
	External thread	.625 x .625 x 4 .750 x .750 x 5 1.00 x 1.00 x 6 1.25 x 1.35 x 7	8 ~32	8~16	8~16
Internal thread		.625 x 6 x .630 .750 x 7 x 1.00 1.00 x 6 x 1.25 1.25 x 8 x 1.50 1.5 x 12 x 2.00 2.00 x 14 x 2.50	--	8~16	8~16

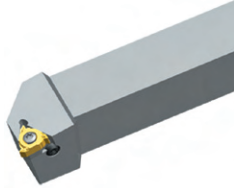
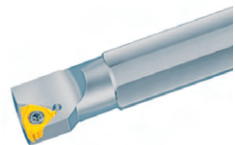
Applications		Petroleum and gas pipeline			
Cutline					
Thread name		API (60°)	API(Round)	API(Buttress casing)	
Profile		60	API	API	
Shape of insert (length: 0.43, 0.63, 0.87inch)		As picture shows R type external threads  P164	As picture shows R type external threads  P165	As picture shows R type external threads  P166	
Tool holder	Pitch	Dimensions (inch) (H×W×L) (Dia×L×Min. dia)	Teeth/Inch	Teeth/Inch	Teeth/Inch
	External thread  P176	.625 x .625 x 4 .750 x .750 x 5 1.00 x 1.00 x 6 1.25 x 1.35 x 7	4~5	8~10	5
Internal thread  P177	.625 x 6 x .630 .750 x 7 x 1.00 1.00 x 6 x 1.25 1.25 x 8 x 1.50 1.5 x 12 x 2.00 2.00 x 14 x 2.50	4~5	8~10	5	

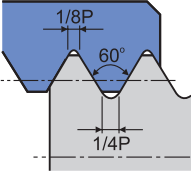
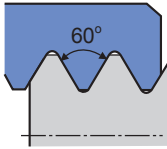
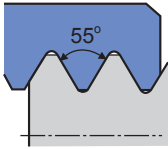
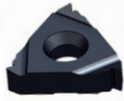
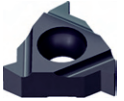
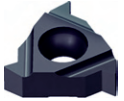
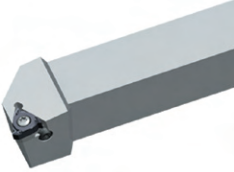
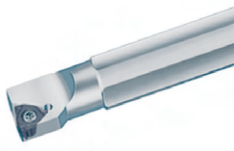

Applications		For general			
Cutline					
Thread name		ISO metric thread With end (Thin type)	General pitch thread Without end (Thin type)	General pitch thread Without end (Thin type)	
Profile		GM	60	55	
Shape of insert (length: 0.43, 0.63, 0.87inch)		As picture shows R type external threads  P167	As picture shows R type external threads  P169	As picture shows R type external threads  P169	
Tool holder	Pitch	Dimensions (inch) (H×W×L) (Dia×L×Min. dia)	Pitch/Inch	Pitch/inch(teeth/Inch)	Pitch/inch(teeth/Inch)
	External thread  P178	.625 x .625 x 4 .750 x .750 x 5 1.00 x 1.00 x 6 1.25 x 1.35 x 7	0.019~0.118	0.019~0.118(8~48)	0.019~0.118(8~48)
Internal thread  P178	.625 x 6 x .630 .750 x 7 x 1.00 1.00 x 6 x 1.25 1.25 x 8 x 1.50 1.5 x 12 x 2.00 2.00 x 14 x 2.50	0.019~0.118	0.019~0.118(8~48)	0.019~0.118(8~48)	



Applications		For general	For aerospace and aviation industries	Pipe thread for heater, gas and water	For connecting between pipe fitting and coupling of gas and water	
Cutline						
Thread name		Whitworth thread (Thin type)	Unified thread (American standard threads, Thin type)	British standard taper pipe threads (Thin type)	American standard taper pipe threads (Thin type)	
Profile		W	UN	BSPT	NPT	
Shape of insert (length: 0.43, 0.63, 0.87inch)		As picture shows R type external threads P170	As picture shows R type external threads P171	As picture shows R type external threads P172	As picture shows R type external threads P173	
Tool holder	Pitch	Teeth/Inch	Teeth/Inch	Teeth/Inch	Teeth/Inch	
	Dimensions (inch) (H×W×L) (Dia×L×Min. dia)					
External thread	 P178	.625 x .625 x 4 .750 x .750 x 5 1.00 x 1.00 x 6 1.25 x 1.35 x 7	8~16	8~20	11~28	8~27
Internal thread	 P178	.625 x 6 x .630 .750 x 7 x 1.00 1.00 x 6 x 1.25 1.25 x 8 x 1.50 1.5 x 12 x 2.00 2.00 x 14 x 2.50	8~16	8~24	11~28	8~27

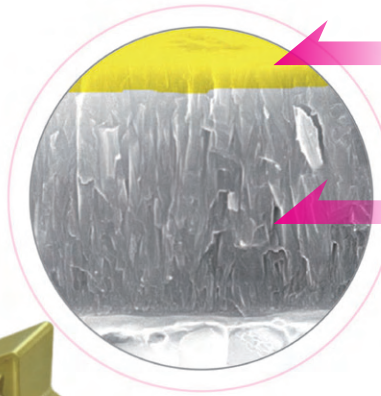
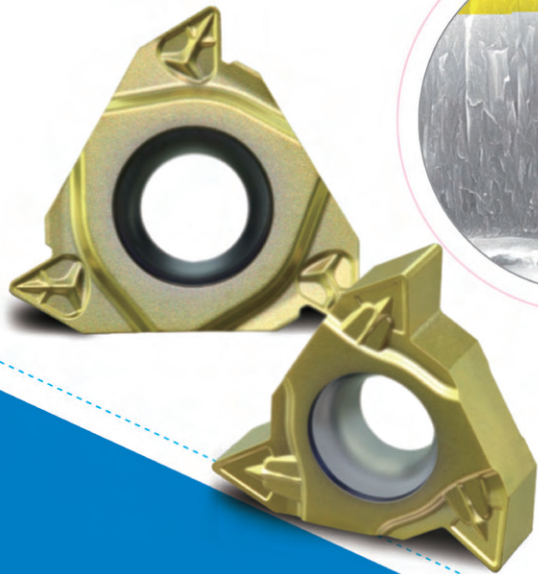

Gold TiN coating reduces friction between cutting edge and workpiece and allows observation of flank wear.

The inner layer nc-TiAlN coating has outstanding wear resistance.



Threading Grade YBG201 is upgraded to be nc-TiAlN

YBG201

PVD coating alloy has good toughness and wear resistance, it's the unique threading grade for machining of carbon steel, stainless steel and cast iron etc.

The function and application of full form threading

Reduce machining procedures

Not necessary to finish machine workpiece prior to threading. Full form insert tops the thread on the last pass and thereby finishes the thread and thread form. No burrs remain and the surface quality is good.

Automatically remove burrs

The wiper on threading insert finishes major diameter of machined surface, eliminating need for burr removal after machining.

Chipbreaker in Threading insert

Outstanding chip breaking performance

Wavy chipbreaker is built into rake face of threading insert. Chips are directed up and away from cutting edge and workpiece to enhance surface finish and overall efficiency.

Good general purpose chipbreaker

Due to the chipbreaker design, which controls and manages the formation of the chip, different workpiece materials can be threaded successfully.

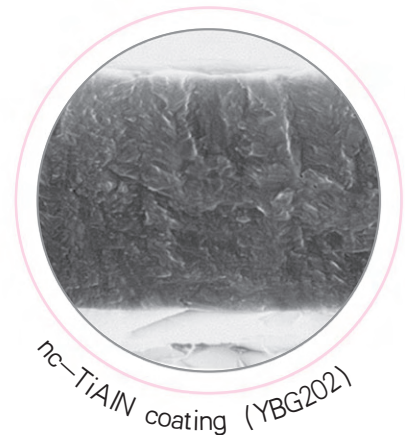

High-performance nanostructure coating guarantees good toughness and hardness of inserts. Special coating technology guarantees smooth surface and excellent wear resistance. Outstanding thermal stability and chemical stability effectively protect cutting edge.

YBG202

nc-TiAlN coating and ultra-fine grain substrate makes it suitable for finishing and semi-finishing of various materials and turning of super alloy.



Code key for threading inserts

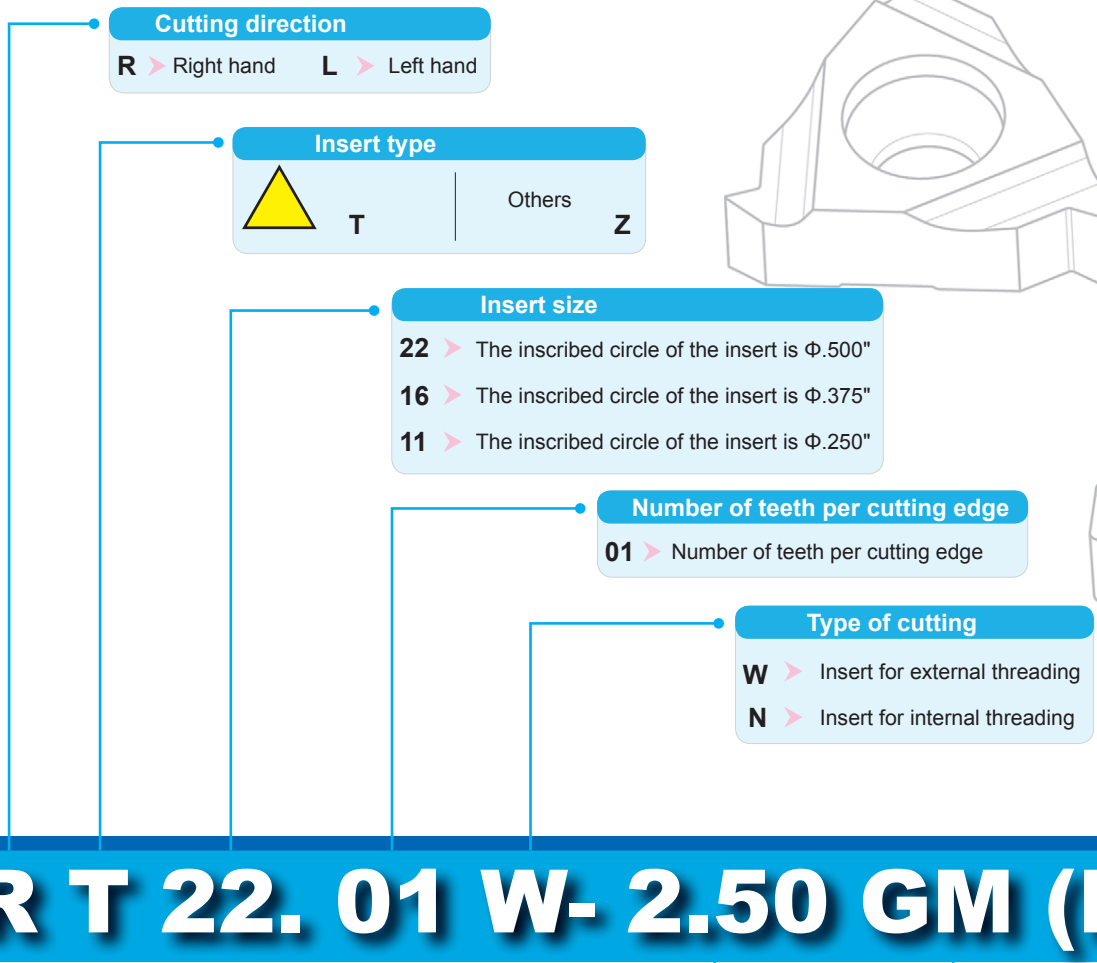

R T 22. 01 W- 2.50 GM (P)

Pitch width

Omni-tooth(Range of pitch indicated in numerals)

inch	TPI
0.014-0.354	72-2

V-tooth(Range of pitch indicated in letters)

	A	AG	G	N	Q
inch	0.019-0.059	0.019-0.118	0.069-0.118	0.138-0.197	0.217-0.236
TPI	48-16	48-8	14-8	7-5	41/2-4

Thread profile

GM	60°ISO metric threads
60	60°general pitch threads
55	55°general pitch threads
W	Whitworth threads
UN	Unified threads(American standard)
BSPT	British standard taper pipe threads
NPT	American standard taper pipe threads
UNJ	American standard aerospace and aviation threads
AC	American ACME
AP	API 60°
RD	API Round

Chip-breakers are indicated by P
(P is omitted when it is metric thread)

ISO metric threading insert

ISO 965-1980 DIN 13
 GB/T 197-2003 Tolerance class: 6g/6H

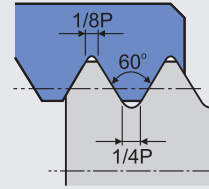

External threading

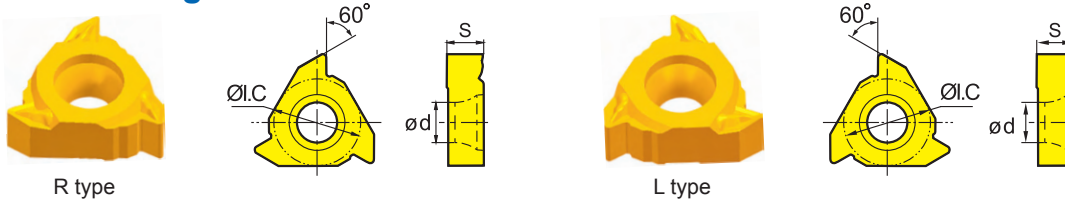

Type		Dimension(inch)				Grade	
Right hand type	Left hand type	Pitch width (inch)	S	ØI.C	Ød	Coated	Uncoated
RT16.01W-1.00GM	LT16.01W-1.00GM	0.039	0.156	0.375	0.173	○	YD201
RT16.01W-1.25GM	LT16.01W-1.25GM	0.049	0.156	0.375	0.173	○	
RT16.01W-1.50GM	LT16.01W-1.50GM	0.059	0.156	0.375	0.173	○	
RT16.01W-1.75GM	LT16.01W-1.75GM	0.069	0.156	0.375	0.173	○	
RT16.01W-2.00GM	LT16.01W-2.00GM	0.079	0.156	0.375	0.173	○	
RT16.01W-2.50GM	LT16.01W-2.50GM	0.098	0.156	0.375	0.173	○	
RT16.01W-3.00GM	LT16.01W-3.00GM	0.118	0.156	0.375	0.173	○	
RT22.01W-3.50GM	LT22.01W-3.50GM	0.138	0.217	0.500	0.217	○	
RT22.01W-4.00GM	LT22.01W-4.00GM	0.157	0.217	0.500	0.217	○	
RT22.01W-4.50GM	LT22.01W-4.50GM	0.177	0.217	0.500	0.217	○	
RT22.01W-5.00GM	LT22.01W-5.00GM	0.197	0.217	0.500	0.217	○	
RT22.01W-5.50GM	LT22.01W-5.50GM	0.217	0.217	0.500	0.217	○	
RT22.01W-6.00GM	LT22.01W-6.00GM	0.236	0.217	0.500	0.217	○	

● Always stock available ○ Produce according to order

ISO metric threading insert

ISO 965-1980 DIN 13
GB/T 197-2003 Tolerance class: 6g/6H

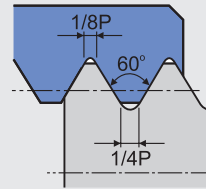

Internal threading

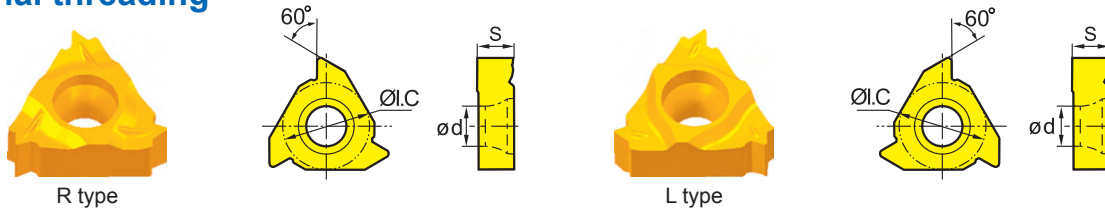

Type		Dimension(inch)				Grade	
		Pitch width (inch)	S	ØI.C	Ød	Coated	Uncoated
Right hand type	Left hand type					YBG201	YD201
RT11.01N-1.00GM	LT11.01N-1.00GM	0.039	0.125	0.250	0.110	○	
RT11.01N-1.25GM	LT11.01N-1.25GM	0.049	0.125	0.250	0.110	○	
RT11.01N-1.50GM	LT11.01N-1.50GM	0.059	0.125	0.250	0.110	○	
RT11.01N-1.75GM	LT11.01N-1.75GM	0.069	0.125	0.250	0.110	○	
RT11.01N-2.00GM	LT11.01N-2.00GM	0.079	0.125	0.250	0.110	○	
RT16.01N-1.00GM	LT16.01N-1.00GM	0.039	0.156	0.375	0.173	○	
RT16.01N-1.25GM	LT16.01N-1.25GM	0.049	0.156	0.375	0.173	○	
RT16.01N-1.50GM	LT16.01N-1.50GM	0.059	0.156	0.375	0.173	○	
RT16.01N-1.75GM	LT16.01N-1.75GM	0.069	0.156	0.375	0.173	○	
RT16.01N-2.00GM	LT16.01N-2.00GM	0.079	0.156	0.375	0.173	○	
RT16.01N-2.50GM	LT16.01N-2.50GM	0.098	0.156	0.375	0.173	○	
RT16.01N-3.00GM	LT16.01N-3.00GM	0.118	0.156	0.375	0.173	○	
RT22.01N-3.50GM	LT22.01N-3.50GM	0.138	0.217	0.500	0.217	○	
RT22.01N-4.00GM	LT22.01N-4.00GM	0.157	0.217	0.500	0.217	○	
RT22.01N-4.50GM	LT22.01N-4.50GM	0.177	0.217	0.500	0.217	○	
RT22.01N-5.00GM	LT22.01N-5.00GM	0.197	0.217	0.500	0.217	○	
RT22.01N-5.50GM	LT22.01N-5.50GM	0.217	0.217	0.500	0.217	○	
RT22.01N-6.00GM	LT22.01N-6.00GM	0.236	0.217	0.500	0.217	○	

● Always stock available ○ Produce according to order



General pitch threading insert without end

External threading

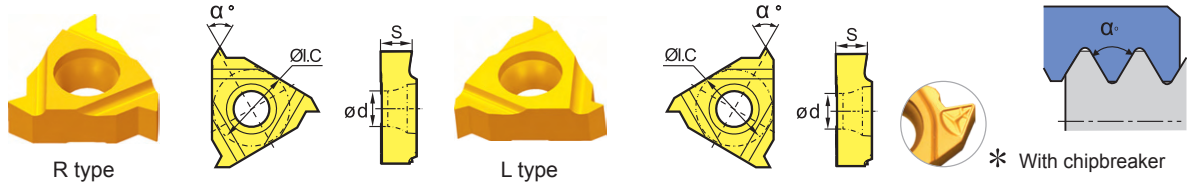

Type		Dimension(inch)					Grade	
		Pitch width (teeth/inch)	S	ØI.C	Ød	Coated	Uncoated	
60°	Right hand type	Left hand type					YBG201	YD201
	RT16.01W-A60	LT16.01W-A60	48-16(0.02-0.059)	0.156	0.375	0.173	●	
	RT16.01W-G60	LT16.01W-G60	14-8(0.069-0.118)	0.156	0.375	0.173	●	
	RT16.01W-G60P*	LT16.01W-G60P*	14-8(0.069-0.118)	0.156	0.375	0.173	●	
	RT16.01W-AG60	LT16.01W-AG60	48-8(0.02-0.118)	0.156	0.375	0.173	●	
55°	Right hand type	Left hand type					YBG201	YD201
	RT22.01W-N60	LT22.01W-N60	7-5(0.138-0.197)	0.219	0.500	0.217	●	
	RT16.01W-A55	LT16.01W-A55	48-16(0.02-0.059)	0.156	0.375	0.173	●	
	RT16.01W-G55	LT16.01W-G55	14-8(0.069-0.118)	0.156	0.375	0.173	●	
	RT16.01W-G55P*	LT16.01W-G55P*	14-8(0.069-0.118)	0.156	0.375	0.173	●	
	RT16.01W-AG55	LT16.01W-AG55	48-8(0.02-0.118)	0.156	0.375	0.173	●	
	RT22.01W-N55	LT22.01W-N55	7-5(0.138-0.197)	0.219	0.500	0.217	●	

● Always stock available ○ Produce according to order

Internal threading

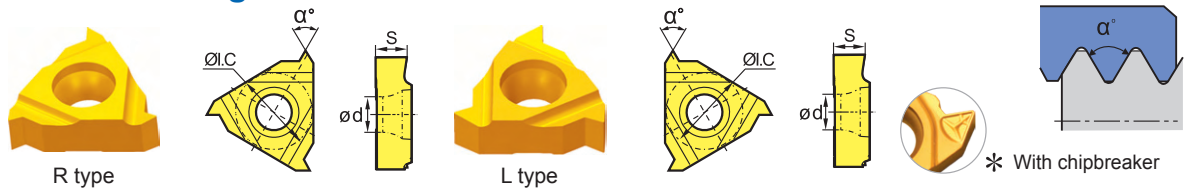

Type		Dimension(inch)					Grade	
		Pitch width (teeth/inch)	S	ØI.C	Ød	Coated	Uncoated	
60°	Right hand type	Left hand type					YBG201	YD201
	RT16.01N-A60	LT16.01N-A60	48-16(0.02-0.059)	0.156	0.375	0.173	●	
	RT16.01N-G60	LT16.01N-G60	14-8(0.069-0.118)	0.156	0.375	0.173	●	
	RT16.01N-G60P*	LT16.01N-G60P*	14-8(0.069-0.118)	0.156	0.375	0.173	●	
	RT16.01N-AG60	LT16.01N-AG60	48-8(0.02-0.118)	0.156	0.375	0.173	●	
55°	Right hand type	Left hand type					YBG201	YD201
	RT22.01N-N60	LT22.01N-N60	7-5(0.138-0.197)	0.219	0.500	0.217	●	
	RT16.01N-A55	LT16.01N-A55	48-16(0.02-0.059)	0.156	0.375	0.173	●	
	RT16.01N-G55	LT16.01N-G55	14-8(0.069-0.118)	0.156	0.375	0.173	●	
	RT16.01N-G55P*	LT16.01N-G55P*	14-8(0.069-0.118)	0.156	0.375	0.173	●	
	RT16.01N-AG55	LT16.01N-AG55	48-8(0.02-0.118)	0.156	0.375	0.173	●	
	RT22.01N-N55	LT22.01N-N55	7-5(0.138-0.197)	0.219	0.500	0.217	●	

● Always stock available ○ Produce according to order

Whitworth threading insert

ISO 228/1:1982,
DIN 259,B.S.84:1956
Tolerance class: Medium class A

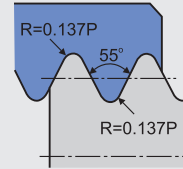

External threading

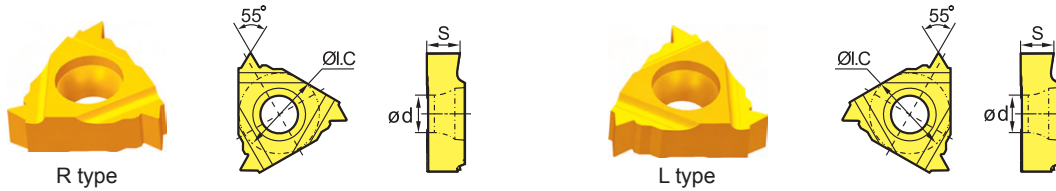

Type		Dimension(inch)				Grade		
Right hand type	Left hand type	Pitch width (teeth/inch)	S	ØI.C	Ød	Coated		Uncoated
RT16.01W-8W	LT16.01W-8W	8	0.156	0.375	0.173	●		
RT16.01W-9W	LT16.01W-9W	9	0.156	0.375	0.173	●		
RT16.01W-10W	LT16.01W-10W	10	0.156	0.375	0.173	●		
RT16.01W-11W	LT16.01W-11W	11	0.156	0.375	0.173	●		
RT16.01W-12W	LT16.01W-12W	12	0.156	0.375	0.173	●		
RT16.01W-14W	LT16.01W-14W	14	0.156	0.375	0.173	●		
RT16.01W-16W	LT16.01W-16W	16	0.156	0.375	0.173	●		

● Always stock available ○ Produce according to order

Internal threading

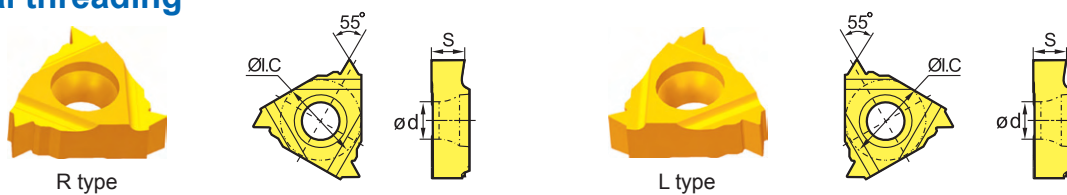

Type		Dimension(inch)				Grade		
Right hand type	Left hand type	Pitch width (teeth/inch)	S	ØI.C	Ød	Coated		Uncoated
RT16.01N-8W	LT16.01N-8W	8	0.156	0.375	0.173	●		
RT16.01N-9W	LT16.01N-9W	9	0.156	0.375	0.173	●		
RT16.01N-10W	LT16.01N-10W	10	0.156	0.375	0.173	●		
RT16.01N-11W	LT16.01N-11W	11	0.156	0.375	0.173	●		
RT16.01N-12W	LT16.01N-12W	12	0.156	0.375	0.173	●		
RT16.01N-14W	LT16.01N-14W	14	0.156	0.375	0.173	●		
RT16.01N-16W	LT16.01N-16W	16	0.156	0.375	0.173	●		

● Always stock available ○ Produce according to order

Unified (UN) threading insert

ASME B1.1-1989
Tolerance class: 2A/2B

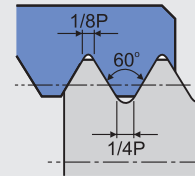

External threading

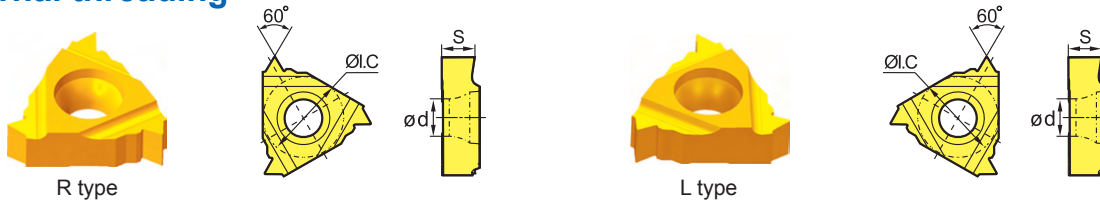

Type		Dimension(inch)				Grade		
Right hand type	Left hand type	Pitch width (teeth/inch)	S	ØI.C	Ød	Coated		Uncoated
RT16.01W-8UN	LT16.01W-8UN	8	0.156	0.375	0.173	●		
RT16.01W-10UN	LT16.01W-10UN	10	0.156	0.375	0.173	●		
RT16.01W-12UN	LT16.01W-12UN	12	0.156	0.375	0.173	●		
RT16.01W-14UN	LT16.01W-14UN	14	0.156	0.375	0.173	●		
RT16.01W-16UN	LT16.01W-16UN	16	0.156	0.375	0.173	●		
RT16.01W-18UN	LT16.01W-18UN	18	0.156	0.375	0.173	●		
RT16.01W-20UN	LT16.01W-20UN	20	0.156	0.375	0.173	●		

● Always stock available ○ Produce according to order

Internal threading

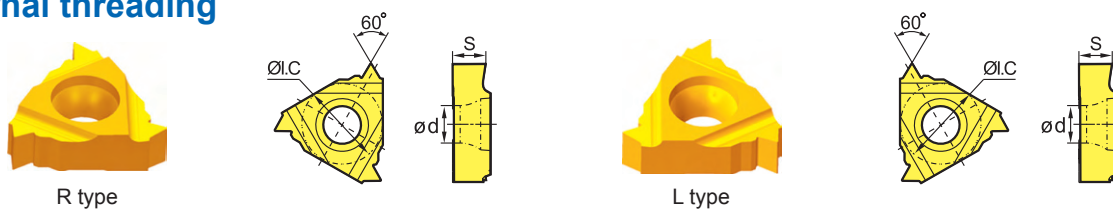

Type		Dimension(inch)				Grade		
Right hand type	Left hand type	Pitch width (teeth/inch)	S	ØI.C	Ød	Coated		Uncoated
RT16.01N-8UN	LT16.01N-8UN	8	0.156	0.375	0.173	●		
RT16.01N-10UN	LT16.01N-10UN	10	0.156	0.375	0.173	●		
RT16.01N-12UN	LT16.01N-12UN	12	0.156	0.375	0.173	●		
RT16.01N-14UN	LT16.01N-14UN	14	0.156	0.375	0.173	●		
RT16.01N-16UN	LT16.01N-16UN	16	0.156	0.375	0.173	●		
RT16.01N-18UN	LT16.01N-18UN	18	0.156	0.375	0.173	●		
RT16.01N-20UN	LT16.01N-20UN	20	0.156	0.375	0.173	●		

● Always stock available ○ Produce according to order

British standard taper pipe threading insert

ISO 7/1:1994
B.S.21:1985
Standard BSPT

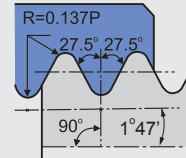

External threading



Type		Dimension(inch)				Grade		
		Pitch width (teeth/inch)	S	ØI.C	Ød	Coated		Uncoated
Right hand type	Left hand type					YBG201	YBM252	YD201
RT16.01W-11 BSPT	LT16.01W-11 BSPT	11	0.156	0.375	0.173	●		
RT16.01W-14 BSPT	LT16.01W-14 BSPT	14	0.156	0.375	0.173	●		
RT16.01W-19 BSPT	LT16.01W-19 BSPT	19	0.156	0.375	0.173	●		
RT16.01W-28 BSPT	LT16.01W-28 BSPT	28	0.156	0.375	0.173	●		

● Always stock available ○ Produce according to order

Internal threading

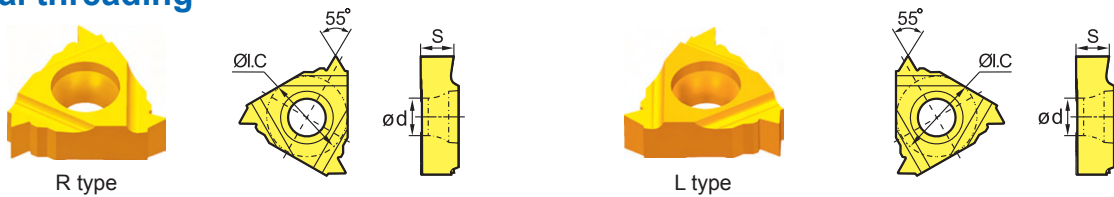

Type		Dimension(inch)				Grade		
		Pitch width (teeth/inch)	S	ØI.C	Ød	Coated		Uncoated
Right hand type	Left hand type					YBG201	YBM252	YD201
RT16.01N-11 BSPT	LT16.01N-11 BSPT	11	0.156	0.375	0.173	●		
RT16.01N-14 BSPT	LT16.01N-14 BSPT	14	0.156	0.375	0.173	●		
RT16.01N-19 BSPT	LT16.01N-19 BSPT	19	0.156	0.375	0.173	●		
RT16.01N-28 BSPT	LT16.01N-28 BSPT	28	0.156	0.375	0.173	●		

● Always stock available ○ Produce according to order

NPT American standard taper pipe threading insert

ASME B1.20.1-1983
Standard NPT

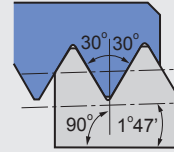

External threading



R type

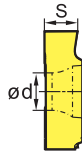
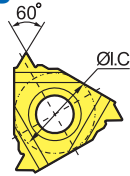

L type

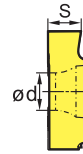
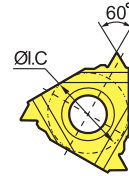

Type		Dimension(inch)				Grade		
Right hand type	Left hand type	Pitch width (teeth/inch)	S	ØI.C	Ød	Coated	Uncoated	
RT16.01W-8 NPT	LT16.01W-8 NPT	8	0.156	0.375	0.173	●		
RT16.01W-11.5 NPT	LT16.01W-11.5 NPT	11.5	0.156	0.375	0.173	●		
RT16.01W-14 NPT	LT16.01W-14 NPT	14	0.156	0.375	0.173	●		
RT16.01W-18 NPT	LT16.01W-18 NPT	18	0.156	0.375	0.173	●		
RT16.01W-27 NPT	LT16.01W-27 NPT	27	0.156	0.375	0.173	●		

● Always stock available ○ Produce according to order

Internal threading



R type

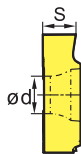
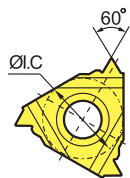

L type

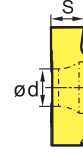
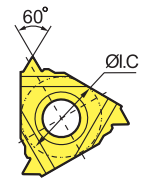

Type		Dimension(inch)				Grade		
Right hand type	Left hand type	Pitch width (teeth/inch)	S	ØI.C	Ød	Coated	Uncoated	
RT16.01N-8 NPT	LT16.01N-8 NPT	8	0.156	0.375	0.173	●		
RT16.01N-11.5 NPT	LT16.01N-11.5 NPT	11.5	0.156	0.375	0.173	●		
RT16.01N-14 NPT	LT16.01N-14 NPT	14	0.156	0.375	0.173	●		
RT16.01N-18 NPT	LT16.01N-18 NPT	18	0.156	0.375	0.173	●		
RT16.01N-27 NPT	LT16.01N-27 NPT	27	0.156	0.375	0.173	●		

● Always stock available ○ Produce according to order

UNJ American standard aerospace and aviation threads

ISO 3161-1999
Tolerance class: 3A

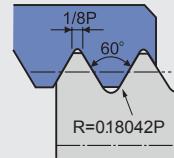

External threading



R type

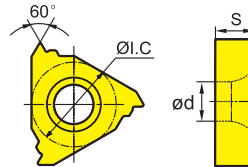

Type	Dimension(inch)				Grade		
	Pitch width (teeth/inch)	S	ØI.C	Ød	Coated		Uncoated
Right hand type					YBG201	YBM252	YD201
RT16.01W-8UNJ	8	0.156	0.375	0.173	●		
RT16.01W-10UNJ	10	0.156	0.375	0.173	●		
RT16.01W-12UNJ	12	0.156	0.375	0.173	●		
RT16.01W-14UNJ	14	0.156	0.375	0.173	●		
RT16.01W-16UNJ	16	0.156	0.375	0.173	●		
RT16.01W-18UNJ	18	0.156	0.375	0.173	●		
RT16.01W-20UNJ	20	0.156	0.375	0.173	●		
RT16.01W-24UNJ	24	0.156	0.375	0.173	●		
RT16.01W-28UNJ	28	0.156	0.375	0.173	●		
RT16.01W-32UNJ	32	0.156	0.375	0.173	●		

● Always stock available ○ Produce according to order



American ACME

ANSI B1.5-1988 ANIS B1.5-1988
Tolerance class: 2G

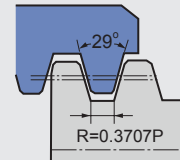

External threading



R type

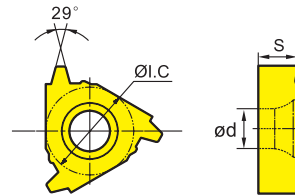

Type	Dimension(inch)				Grade		
	Pitch width (teeth/inch)	S	ØI.C	Ød	Coated		Uncoated
Right hand type					YBG201	YBM252	YD201
RT16.01W-8AC	8	0.156	0.375	0.173	●		
RT16.01W-10AC	10	0.156	0.375	0.173	●		
RT16.01W-12AC	12	0.156	0.375	0.173	●		
RT16.01W-14AC	14	0.156	0.375	0.173	●		
RT16.01W-16AC	16	0.156	0.375	0.173	●		

● Always stock available ○ Produce according to order

Internal threading



R type

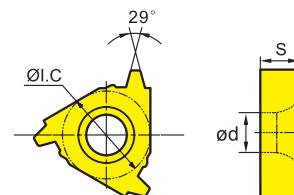

Type	Dimension(inch)				Grade		
	Pitch width (teeth/inch)	S	ØI.C	Ød	Coated		Uncoated
Right hand type					YBG201	YBM252	YD201
RT16.01N-8AC	8	0.156	0.375	0.173	●		
RT16.01N-10AC	10	0.156	0.375	0.173	●		
RT16.01N-12AC	12	0.156	0.375	0.173	●		
RT16.01N-14AC	14	0.156	0.375	0.173	●		
RT16.01N-16AC	16	0.156	0.375	0.173	●		

● Always stock available ○ Produce according to order

American STUB—ACME (short tooth threads)

Defined by: ANSI B1.8-1988
Tolerance class: 2G

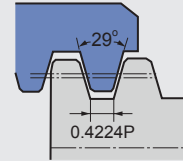

External threading



R type

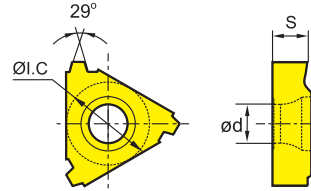

Type	Dimension(inch)				Grade		
	Pitch width (teeth/inch)	S	ØI.C	Ød	Coated		Uncoated
Right hand type					YBG201	YBM252	YD201
RT16.01W-8STAC	8	0.156	0.375	0.173	●		
RT16.01W-10STAC	10	0.156	0.375	0.173	●		
RT16.01W-12STAC	12	0.156	0.375	0.173	●		
RT16.01W-14STAC	14	0.156	0.375	0.173	●		
RT16.01W-16STAC	16	0.156	0.375	0.173	●		

● Always stock available ○ Produce according to order

Internal threading



R type

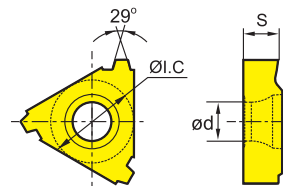

Type	Dimension(inch)				Grade		
	Pitch width (teeth/inch)	S	ØI.C	Ød	Coated		Uncoated
Right hand type					YBG201	YBM252	YD201
RT16.01N-8STAC	8	0.156	0.375	0.173	●		
RT16.01N-10STAC	10	0.156	0.375	0.173	●		
RT16.01N-12STAC	12	0.156	0.375	0.173	●		
RT16.01N-14STAC	14	0.156	0.375	0.173	●		
RT16.01N-16STAC	16	0.156	0.375	0.173	●		

● Always stock available ○ Produce according to order

API 60°

Me=Taper
 2i.p.f—4° 46'
 3i.p.f—7° 01'
 Defined by: API SPEC7:1990
 Tolerance class: API

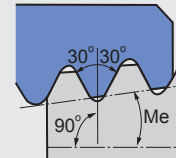

External threading



R type

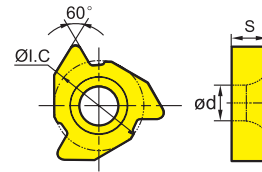

Type	Dimension(inch)				Grade		
	Pitch width (teeth/inch)	S	ØI.C	Ød	Coated		Uncoated
Right hand type					YBG201	YBM252	YD201
RT22.01W-4AP382	4	0.219	0.500	0.217	●		
RT22.01W-4AP383	4	0.219	0.500	0.217	●		
RT22.01W-5AP403	5	0.219	0.500	0.217	●		
RT22.01W-4AP502	4	0.219	0.500	0.217	●		
RT22.01W-4AP503	4	0.219	0.500	0.217	●		

● Always stock available ○ Produce according to order

Internal threading



R type

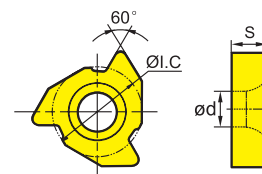

Type	Dimension(inch)				Grade		
	Pitch width (teeth/inch)	S	ØI.C	Ød	Coated		Uncoated
Right hand type					YBG201	YBM252	YD201
RT22.01N-4AP382	4	0.219	0.500	0.217	●		
RT22.01N-4AP383	4	0.219	0.500	0.217	●		
RT22.01N-5AP403	5	0.219	0.500	0.217	●		
RT22.01N-4AP502	4	0.219	0.500	0.217	●		
RT22.01N-4AP503	4	0.219	0.500	0.217	●		

● Always stock available ○ Produce according to order

API Round

Defined by: API spec.5B
Tolerance class: API RD

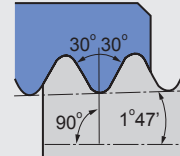

External threading



R type

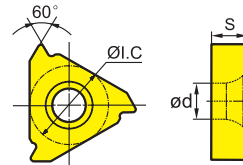

Type	Dimension(inch)				Grade		
	Pitch width (teeth/inch)	S	ØI.C	Ød	Coated	Uncoated	
Right hand type					YBG201	YBM252	YD201
RT16.01W-8RD	8	0.156	0.375	0.173	●		
RT16.01W-10RD	10	0.156	0.375	0.173	●		
RT22.01W-8RD	8	0.219	0.500	0.217	●		
RT22.01W-10RD	10	0.219	0.500	0.217	●		

● Always stock available ○ Produce according to order



Internal threading



R type

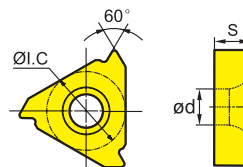

Type	Dimension(inch)				Grade		
	Pitch width (teeth/inch)	S	ØI.C	Ød	Coated	Uncoated	
Right hand type					YBG201	YBM252	YD201
RT16.01N-8RD	8	0.156	0.375	0.173	●		
RT16.01N-10RD	10	0.156	0.375	0.173	●		
RT22.01N-8RD	8	0.219	0.500	0.217	●		
RT22.01N-10RD	10	0.219	0.500	0.217	●		

● Always stock available ○ Produce according to order

API Buttress Casing

Me=Taper: 3/4i.p.f-1° 47' suited for dia.4 1/2~13 3/8"
 1i.p.f-2° 23' suited for dia.16"
 Defined by: SEPC.5B.1979
 Tolerance class: API

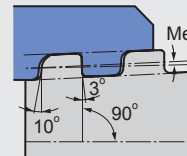

External threading

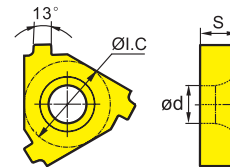

Type	Dimension(inch)				Grade		
	Pitch width (teeth/inch)	S	ØI.C	Ød	Coated		Uncoated
Right hand type					YBG201	YBM252	YD201
RT22.01W-5BUT	5	0.219	0.500	0.217	●		
RT22.01W-5BUT1	5	0.219	0.500	0.217	●		

● Always stock available ○ Produce according to order

Internal threading

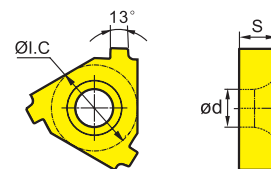

Type	Dimension(inch)				Grade		
	Pitch width (teeth/inch)	S	ØI.C	Ød	Coated		Uncoated
Right hand type					YBG201	YBM252	YD201
RT22.01W-5BUT	5	0.219	0.500	0.217	●		
RT22.01W-5BUT1	5	0.219	0.500	0.217	●		

● Always stock available ○ Produce according to order

ISO metric threading insert (thin type)

ISO 965-1980, DIN 13, GB/T 197-2003
Tolerance class: 6g/6H

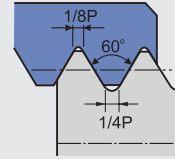

External threading

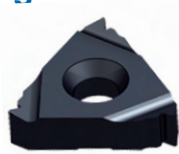

R type

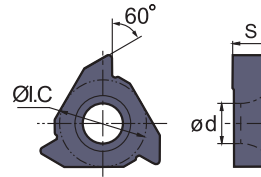

Type	Dimension(inch)				Coated
	Pitch width	S	ØI.C	Ød	
Right hand type					YBG202
RT16.01W-0.5GMB	0.019	0.139	0.375	0.157	●
RT16.01W-0.75GMB	0.030	0.139	0.375	0.157	●
RT16.01W-1.00GMB	0.039	0.139	0.375	0.157	●
RT16.01W-1.25GMB	0.049	0.139	0.375	0.157	●
RT16.01W-1.50GMB	0.059	0.139	0.375	0.157	●
RT16.01W-1.75GMB	0.069	0.139	0.375	0.157	●
RT16.01W-2.00GMB	0.079	0.139	0.375	0.157	●
RT16.01W-2.50GMB	0.098	0.139	0.375	0.157	●
RT16.01W-3.00GMB	0.118	0.139	0.375	0.157	●

● Always stock available ○ Produce according to order

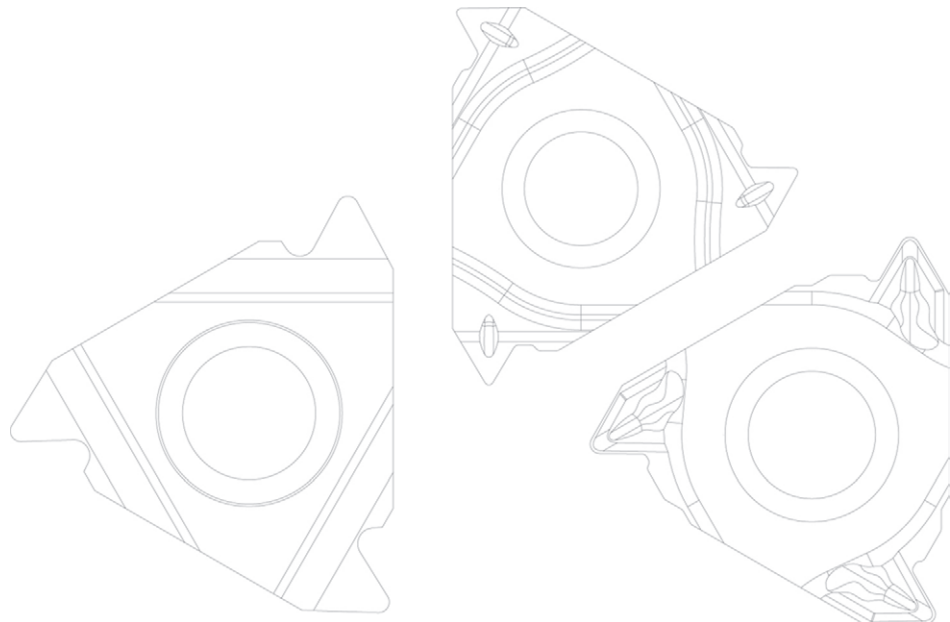

ISO metric threading insert (thin type)

ISO 965-1980, DIN 13, GB/T 197-2003
Tolerance class: 6g/6H

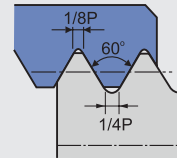

Internal threading

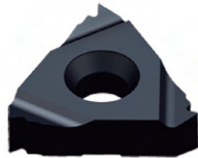

R type

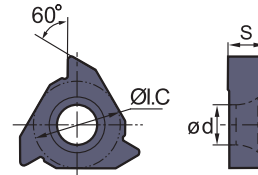

Type	Dimension(inch)				Coated
	Pitch width	S	ØI.C	Ød	
Right hand type					YBG202
RT16.01N-0.5GMB	0.019	0.139	0.375	0.157	●
RT16.01N-0.75GMB	0.030	0.139	0.375	0.157	●
RT16.01N-1.00GMB	0.039	0.139	0.375	0.157	●
RT16.01N-1.25GMB	0.049	0.139	0.375	0.157	●
RT16.01N-1.50GMB	0.059	0.139	0.375	0.157	●
RT16.01N-1.75GMB	0.069	0.139	0.375	0.157	●
RT16.01N-2.00GMB	0.079	0.139	0.375	0.157	●
RT16.01N-2.50GMB	0.098	0.139	0.375	0.157	●
RT16.01N-3.00GMB	0.118	0.139	0.375	0.157	●

● Always stock available ○ Produce according to order

C

General pitch threading insert without end (thin type)

External threading

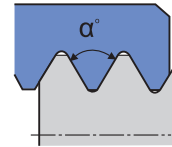
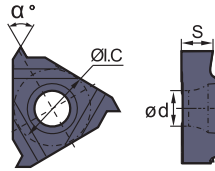
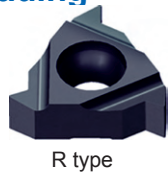

Type		Dimension(inch)					Coated
	Right hand type	Pitch width (teeth/inch)	S	ØI.C	Ød	α°	YBG202
60°	RT16.01W- A60B	0.5 ~1.5(48~16)	0.139	0.375	0.157	60°	●
	RT16.01W- G60B	1.75~3.0(14~8)	0.139	0.375	0.157	60°	●
	RT16.01W- AG60B	0.5 ~3.0(48~8)	0.139	0.375	0.157	60°	●
55°	RT16.01W- A55B	0.5 ~1.5(48~16)	0.139	0.375	0.157	55°	●
	RT16.01W- G55B	1.75~3.0(14~8)	0.139	0.375	0.157	55°	●
	RT16.01W- AG55B	0.5 ~3.0(48~8)	0.139	0.375	0.157	55°	●

● Always stock available ○ Produce according to order



Internal threading

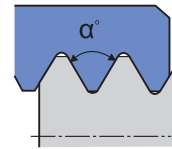
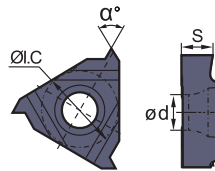
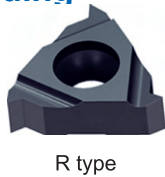

Type		Dimension(inch)					Coated
	Right hand type	Pitch width (teeth/inch)	S	ØI.C	Ød	α°	YBG202
60°	RT16.01N- A60B	0.5 ~1.5(48~16)	0.139	0.375	0.157	60°	●
	RT16.01N- G60B	1.75~3.0(14~8)	0.139	0.375	0.157	60°	●
	RT16.01N- AG60B	0.5 ~3.0(48~8)	0.139	0.375	0.157	60°	●
55°	RT16.01N- A55B	0.5 ~1.5(48~16)	0.139	0.375	0.157	55°	●
	RT16.01N- G55B	1.75~3.0(14~8)	0.139	0.375	0.157	55°	●
	RT16.01N- AG55B	0.5 ~3.0(48~8)	0.139	0.375	0.157	55°	●

● Always stock available ○ Produce according to order

Whitworth threading insert (thin type)

ISO 228/1:1982, DIN 259, B.S.84:1956
Tolerance class: Medium class A

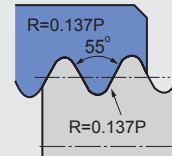

External threading

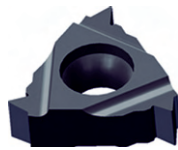

R type

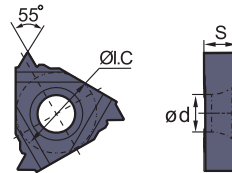

Type	Dimension(inch)				Coated
	Pitch width (teeth/inch)	S	ØI.C	Ød	
Right hand type					YBG202
RT16.01W-8WB	8	0.139	0.375	0.157	●
RT16.01W-9WB	9	0.139	0.375	0.157	●
RT16.01W-10WB	10	0.139	0.375	0.157	●
RT16.01W-11WB	11	0.139	0.375	0.157	●
RT16.01W-12WB	12	0.139	0.375	0.157	●
RT16.01W-14WB	14	0.139	0.375	0.157	●
RT16.01W-16WB	16	0.139	0.375	0.157	●

● Always stock available ○ Produce according to order

Internal threading



R type

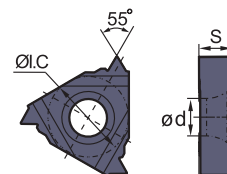

Type	Dimension(inch)				Coated
	Pitch width (teeth/inch)	S	ØI.C	Ød	
Right hand type					YBG202
RT16.01N-8WB	8	0.139	0.375	0.157	●
RT16.01N-9WB	9	0.139	0.375	0.157	●
RT16.01N-10WB	10	0.139	0.375	0.157	●
RT16.01N-11WB	11	0.139	0.375	0.157	●
RT16.01N-12WB	12	0.139	0.375	0.157	●
RT16.01N-14WB	14	0.139	0.375	0.157	●
RT16.01N-16WB	16	0.139	0.375	0.157	●

● Always stock available ○ Produce according to order

Unified (UN) threading insert (thin type)

ASME B1.1-1989
Tolerance class: 2A/2B

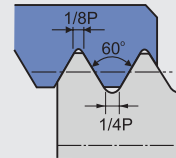

External threading

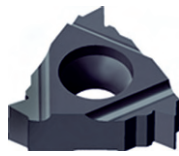

R type

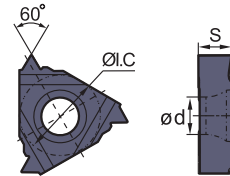

Type	Dimension(inch)				Coated
Right hand type	Pitch width (teeth/inch)	S	ØI.C	Ød	YBG202
RT16.01W-8UNB	8	0.139	0.375	0.157	●
RT16.01W-10UNB	10	0.139	0.375	0.157	●
RT16.01W-12UNB	12	0.139	0.375	0.157	●
RT16.01W-14UNB	14	0.139	0.375	0.157	●
RT16.01W-16UNB	16	0.139	0.375	0.157	●
RT16.01W-18UNB	18	0.139	0.375	0.157	●
RT16.01W-20UNB	20	0.139	0.375	0.157	●

● Always stock available ○ Produce according to order

Internal threading



R type

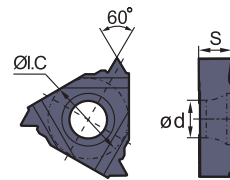

Type	Dimension(inch)				Coated
Right hand type	Pitch width (teeth/inch)	S	ØI.C	Ød	YBG202
RT16.01N-8UNB	8	0.139	0.375	0.157	●
RT16.01N-10UNB	10	0.139	0.375	0.157	●
RT16.01N-12UNB	12	0.139	0.375	0.157	●
RT16.01N-14UNB	14	0.139	0.375	0.157	●
RT16.01N-16UNB	16	0.139	0.375	0.157	●
RT16.01N-18UNB	18	0.139	0.375	0.157	●
RT16.01N-20UNB	20	0.139	0.375	0.157	●
RT16.01N-24UNB	24	0.139	0.375	0.157	●

● Always stock available ○ Produce according to order

British standard taper pipe threading insert (thin type)

ISO 7/1:1994, B.S.21:1985
Standard BSPT

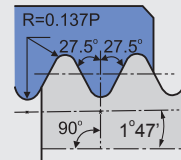

External threading



R type

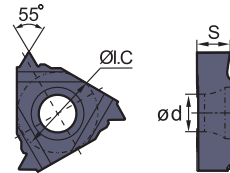

Type	Dimension (inch)				Coated
	Pitch width (teeth/inch)	S	ØI.C	Ød	
Right hand type					YBG202
RT16.01W-11BSPTB	11	0.139	0.375	0.157	●
RT16.01W-14BSPTB	14	0.139	0.375	0.157	●
RT16.01W-19BSPTB	19	0.139	0.375	0.157	●
RT16.01W-28BSPTB	28	0.139	0.375	0.157	●

● Always stock available ○ Produce according to order

Internal threading

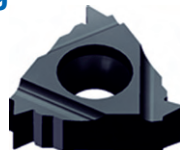

R type

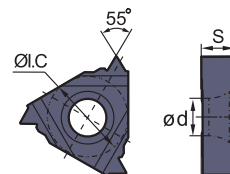

Type	Dimension (inch)				Coated
	Pitch width (teeth/inch)	S	ØI.C	Ød	
Right hand type					YBG202
RT16.01N-11BSPTB	11	0.139	0.375	0.157	●
RT16.01N-14BSPTB	14	0.139	0.375	0.157	●
RT16.01N-19BSPTB	19	0.139	0.375	0.157	●
RT16.01N-28BSPTB	28	0.139	0.375	0.157	●

● Always stock available ○ Produce according to order

NPT American standard taper pipe threading insert (thin type)

ASME B1.20.1-1983
Standard NPT

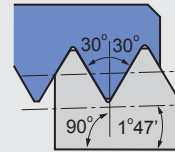

External threading



R type

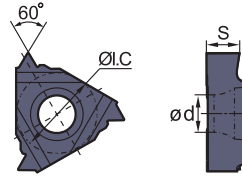

Type	Dimension(inch)				Coated
	Pitch width (teeth/inch)	S	ØI.C	Ød	
Right hand type					YBG202
RT16.01W-8NPTB	8	0.139	0.375	0.157	●
RT16.01W-11.5NPTB	11.5	0.139	0.375	0.157	●
RT16.01W-14NPTB	14	0.139	0.375	0.157	●
RT16.01W-18NPTB	18	0.139	0.375	0.157	●
RT16.01W-27NPTB	27	0.139	0.375	0.157	●

● Always stock available ○ Produce according to order

Internal threading



R type

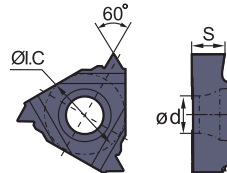

Type	Dimension(inch)				Coated
	Pitch width (teeth/inch)	S	ØI.C	Ød	
Right hand type					YBG202
RT16.01N-8NPTB	8	0.139	0.375	0.157	●
RT16.01N-11.5NPTB	11.5	0.139	0.375	0.157	●
RT16.01N-14NPTB	14	0.139	0.375	0.157	●
RT16.01N-18NPTB	18	0.139	0.375	0.157	●
RT16.01N-27NPTB	27	0.139	0.375	0.157	●

● Always stock available ○ Produce according to order

Clamping system

Top clamping Screw clamping

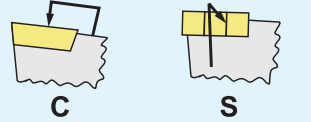

Thread type

- N** > Internal thread
- W** > External thread

Cutting direction

Right hand Left hand

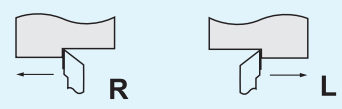

S W R 12 C 03 B

Shank height and width

Code	10	12	16	20
Tool body dimension(inch)	0.625×0.625	0.750×0.750	1.000×1.000	1.250×1.250

Tool length

Code	J	A	B	C	D	E	F
Length(inch)	3-1/2	4	4-1/2	5	3	7	8

Cutting edge length

Number of 1/8" of I.C	I.C inch	C	D	R	S	T	V	W
						09		
2	1/4	06	07			11	11	
3	3/8	09	11	09	09	16	16	06
4	1/2	12	15	12	12	22	22	08
5	5/8	16	09	15	15	27		
6	3/4	19		19	19	33		
8	1	25		25	25	44		

Thin type threading tools

Clamping system

Top clamping Screw clamping

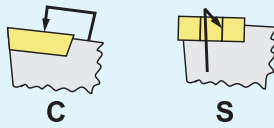

Thread type

- N** > Internal thread
- W** > External thread

Cutting direction

Right hand Left hand

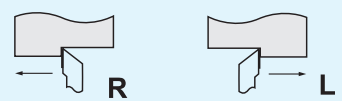

S N R 0750 M 03 B

Shank diameter

Code	0625	0750	1000	1500
Tool body dimension(inch)	0.625	0.750	1.000	1.500

Tool length

Code	H	K	M	Q	R	S	T
Length(inch)	4	5	6	7	8	10	12

Cutting edge length

Number of 1/8" of I.C	I.C inch	C	D	R	S	T	V	W
						09		
2	1/4	06	07			11	11	
3	3/8	09	11	09	09	16	16	06
4	1/2	12	15	12	12	22	22	08
5	5/8	16	09	15	15	27		
6	3/4	19		19	19	33		
8	1	25		25	25	44		

Thin type threading tools

C

External threading tools

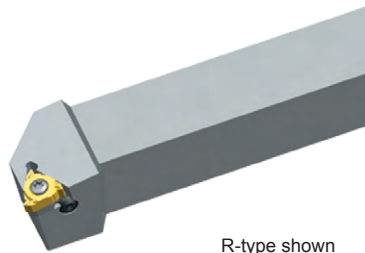

R-type shown

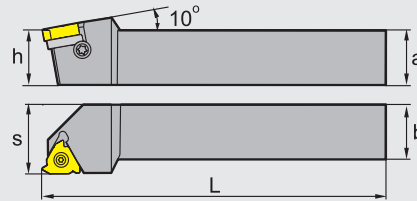

Type	Stock	Basic dimensions(inch)					Applicable inserts	Inserts screw	Shim	Shim screw	Wrench	
		a	h	b	L	s						
SWR	▲ 10A03	▲	0.625	0.625	0.625	4	RT16.01W-□□□□	I60M3.5×12	MT16-□□M	SM4×8C	WT15IP WH25L	
	▲ 12C03	▲	0.750	0.750	0.750	5						1.00
	▲ 16D03	▲	1.000	1.000	1.000	6						1.25
	▲ 85E03	▲	1.250	1.250	1.000	7						1.25
	▲ 20E03	▲	1.250	1.250	1.250	7	1.50	RT22.01W-□□□□	I60M5×17	MT22-□□M	WT20IP WH25L	
	▲ 16D04	▲	1.000	1.000	1.000	6	1.25					
	▲ 16E04	▲	1.000	1.000	1.000	7	1.25					
	▲ 20E04	▲	1.250	1.250	1.250	7	1.50					
SWL	▲ 10A03	▲	0.625	0.625	0.625	4	LT16.01W-□□□□	I60M3.5×12	MT16-□□M	SM4×8C	WT15IP WH25L	
	▲ 12C03	▲	0.750	0.750	0.750	5						1.00
	▲ 16D03	▲	1.000	1.000	1.000	6						1.25
	▲ 85E03	▲	1.250	1.250	1.000	7						1.25
	▲ 20E03	▲	1.250	1.250	1.250	7	1.75	LT22.01W-□□□□	I60M5×17	MT22-□□M	WT20IP WH25L	
	▲ 16D04	▲	1.000	1.000	1.000	6	1.25					
	▲ 16E04	▲	1.000	1.000	1.000	7	1.25					
	▲ 20E04	▲	1.250	1.250	1.250	7	1.50					

▲ Stock available △ Make-to-order

Internal threading tools

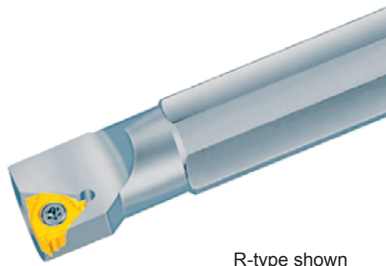

R-type shown

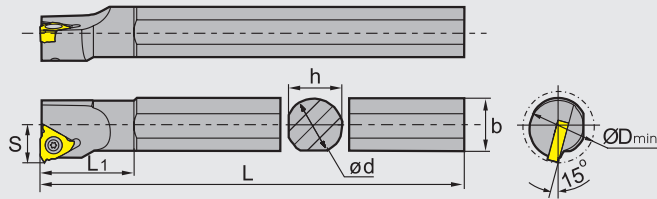

Type	Stock	Basic dimensions(inch)							Applicable inserts	Inserts screw	Shim	Shim screw	Wrench	
		Ød	L	b	ØD _{min}	s	h	L ₁						
SNR	0625K02	▲	0.625	5	0.63	0.50	0.394	0.591	0.823	RT11.01N-□□□□	I60 M2.5X6.5	--	SM4X8C	WT07IP
	0625M02	▲	0.625	6	0.61	0.63	0.413	0.591	1.020					
	0625M03	▲	0.625	6	0.61	0.80	0.472	0.591	1.063					
	0750M03	▲	0.75	6	0.748	1.00	0.551	0.709	1.130					
	0750Q03	▲	0.75	7	0.748	1.00	0.551	0.709	1.339					
	1000M03	▲	1.00	6	0.945	1.25	0.669	0.906	1.134					
	1250R03	▲	1.25	8	1.22	1.50	0.866	1.181	1.217					
	1250S03	▲	1.25	10	1.22	1.50	0.866	1.181	1.217					
	1500T03	▲	1.50	12	1.516	2.00	1.063	1.457	1.240					
	2000U03	▲	2.00	14	1.949	2.50	1.378	1.929	1.583					
	0750Q04	▲	0.75	7	0.846	1.00	0.591	0.709	1.378					
	1000R04	▲	1.00	8	0.945	1.25	0.748	0.906	1.535					
	1250S04	▲	1.25	10	1.22	1.50	0.866	1.181	1.433					
	1500T04	▲	1.50	12	1.516	2.00	1.063	1.457	1.465					
2000U04	▲	2.00	14	1.909	2.50	1.378	1.85	1.677						
SNL	0625K02	▲	0.625	5	0.63	0.50	0.394	0.591	0.823	LT11.01N-□□□□	I60 M2.5X6.5	--	SM4X8C	WT07IP
	0625M02	▲	0.625	6	0.61	0.63	0.413	0.591	1.020					
	0625M03	▲	0.625	6	0.61	0.80	0.472	0.591	1.063					
	0750M03	▲	0.75	6	0.748	1.00	0.551	0.709	1.130					
	0750Q03	▲	0.75	7	0.748	1.00	0.551	0.709	1.339					
	1000M03	▲	1.00	6	0.945	1.25	0.669	0.906	1.134					
	1250R03	▲	1.25	8	1.22	1.50	0.866	1.181	1.217					
	1250S03	▲	1.25	10	1.22	1.50	0.866	1.181	1.217					
	1500T03	▲	1.50	12	1.516	2.00	1.063	1.457	1.240					
	2000U03	▲	2.00	14	1.949	2.50	1.378	1.929	1.583					
	0750Q04	▲	0.75	7	0.846	1.00	0.591	0.709	1.378					
	1000R04	▲	1.00	8	0.945	1.25	0.748	0.906	1.535					
	1250S04	▲	1.25	10	1.22	1.50	0.866	1.181	1.433					
	1500T04	▲	1.50	12	1.516	2.00	1.063	1.457	1.465					
2000U04	▲	2.00	14	1.909	2.50	1.378	1.85	1.677						

▲ Stock available △ Make-to-order



External threading tools (For thin type threading)

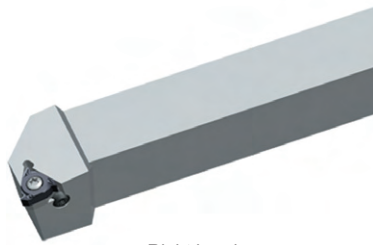

Right hand

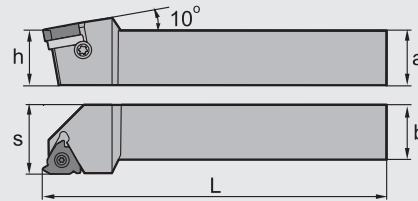

Type		Dimensions(inch)					Applicable inserts	Inserts screw	Shim	Shim screw	Wrench
		a	h	b	L	s					
SWR	10A03B	0.625	0.625	0.625	4	0.75	RT16.01W-□□□□B	I60M3.5x12TT	MT16-□□M	SM4x8C	WT15IP
	12C03B	0.750	0.750	0.750	5	1.00					
	16D03B	1.00	1.00	1.00	6	1.25					
	20E03B	1.25	1.25	1.25	7	1.50					

Internal threading tools (For thin type threading)

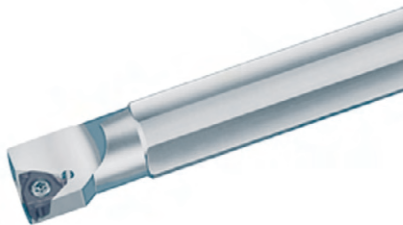

Right hand

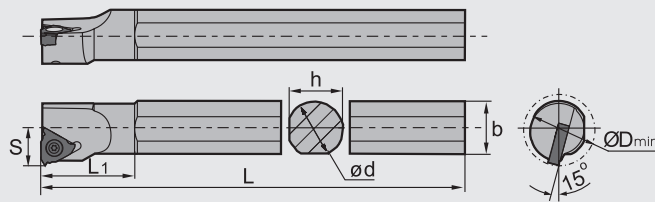

Type		Dimensions(inch)							Applicable inserts	Inserts screw	Shim	Shim screw	Wrench
		Ød	L	b	ØD _{min}	S	h	L ₁					
SNR	0625M03B	0.625	6.00	0.610	0.75	0.472	0.591	1.063	RT16.01W-□□□□B	I60M3.5x8TT	MT16-□□M	SM4x8C	WT15IP
	0750Q03B	0.75	7.00	0.748	1.00	0.551	0.709	1.339		I60M3.5x12TT			
	1000M03B	1.00	6.00	0.945	1.25	0.669	0.906	1.134					
	1250R03B	1.25	8.00	1.220	1.50	0.866	1.181	1.217					
	1250S03B	1.25	10.00	1.220	1.50	0.866	1.181	1.217					

● Machining way of threading tools

External threading machining (Right thread)

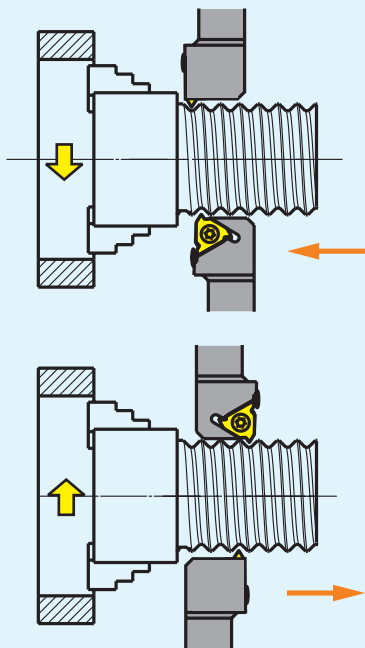

External threading machining (Left thread)

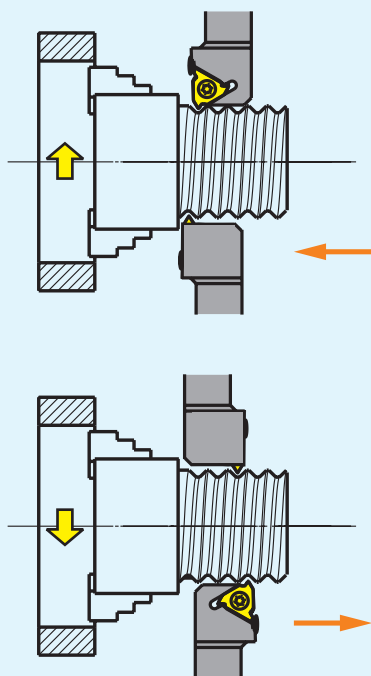

Please follow the following steps to get the best threading result:

- ① Select proper thread machining method.
- ② Decide helical angle, select shim.
- ③ Choose proper insert and toolholder size.
- ④ By checking reference table of standard threading program, select feasible cutting parameters.
- ⑤ Selection feed way.

Internal threading machining (Right thread)

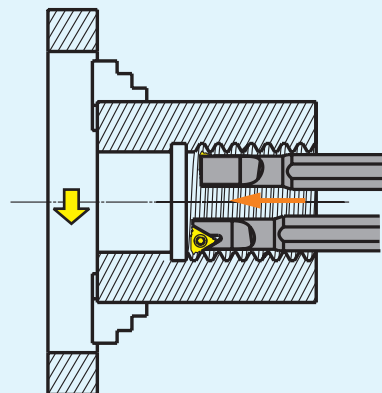

Internal threading machining (Left thread)

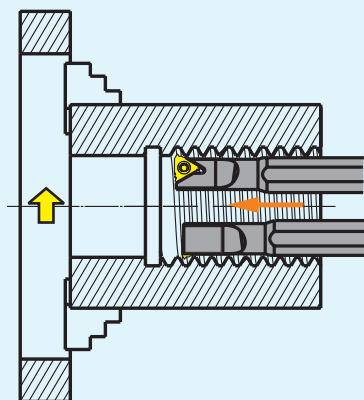

C

Decide helical angle, select shim

The cutting edge clearance angle affects the dissipation of heat, balance of insert wear, thread pitch quality, and security of the cutting edge. The clearance angle of thread pitch on clearance face is determined by thread helical angle. These two angles are similar to each other. If the inclined angle of the insert is different from the helical angle, then clearance angle won't be the same. The pitch of the helical angle must be the same as the inclined angle of the insert in order to prevent premature wear on the clearance face. The helical angle is calculated as below:

$$\rho = \arctan \frac{P}{d_2 \times \pi}$$

P=Pitch

d₂=pitch diameter

The common inclined angle is 1°, MT standard shim and its inclined angle is 1° too

The calculation of clearance angle:

Clearance angle β is calculated as below:

$$\beta = \arcc(\tan \theta \times \tan \alpha)$$

2θ=Thread profile angle

α=The rake angle of external standard

threading tools is 10°; The rake angle of internal standard threading tools is 15°

The shim has to be changed when helical angle of thread is ≤ clearance angle of the insert, which would cause interference with insert flank. Please change shim to adjust the difference between helical angle of thread and inclined angle of shim to be within 2°~0°.

For Example: when P=1.5, d₂=24mm
 Helical Angle 1.14°-(2°~0°)=Inclined Angle
 (-0.86°~1.14°)
 It's feasible by using standard shim 1°.

Shim specification table are as following:

Screw pitch range	Insert dimensions	Inclined angle	Shim
0.5-3.0	16	0	MT16-00M
		1	MT16-01M
		2	MT16-02M
		3	MT16-03M
3.5-6.0	22	0	MT22-00M
		1	MT22-01M
		2	MT22-02M
		3	MT22-03M

Note: The standard angle of shim for our threading tools is 1° (MT16-01M or MT22-01M)

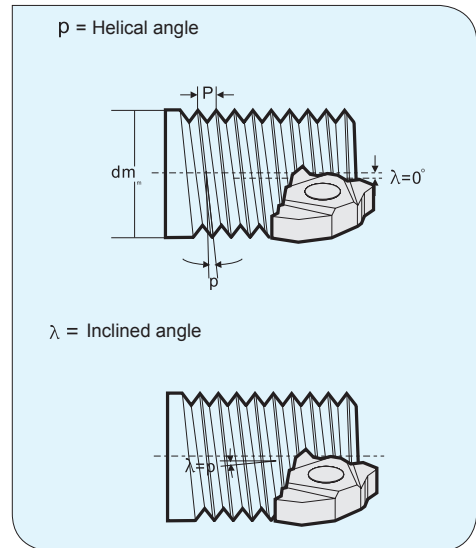

Please refer to table below for actual value:

Thread profile angle 2θ	β	
	External thread	Internal thread
60°	8.5°	6°
55°	7°	7°
30°	4°	2.5°
29°	4°	2.5°

Select shim:

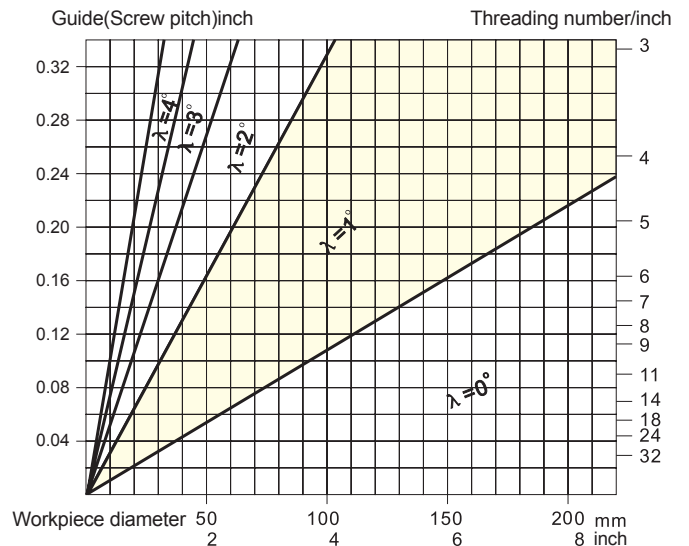

Table of recommended cutting parameters

ISO	Material		Unit cutting force Kc0.4 N/mm ²	Hardness HB	Grade	
					YBG203 YBG205	
					Cutting speed(SFPM)	
P	Carbon steel	C=0.15%	1900	125	500-600	
		C=0.35%	2100	150	450-500	
		C=0.60%	2250	200	400-500	
	Alloy steel	Anneal	2100	180	360-400	
Hardened		2600	275	260-300		
Hardened		2700	300	230-300		
Hardened		2850	350	200-260		
High alloy steel	Anneal	2600	200	300-400		
	Hardened	3900	325	230-300		
Cast steel	Non-alloy	2000	180	600-700		
	low alloy	2500	200	300-400		
	high alloy	2700	225	300-400		
	Martensite steel 12%Mn	3600	250	130-160		
M	Stainless steel	Austenite	2450	180	360-400	
		Martensite/Ferrite	2300	200	400-550	
K	Malleable cast iron	Ferrite	1100	130	360-450	
		Pearlite	1100	230	300-300	
	Gray cast iron	Low tensile-strength	1100	180	360-450	
High tensile-strength		1500	260	300-350		
Nodular cast iron	Ferrite	1100	160	360-400		
	Pearlite	1800	250	260-300		
N	Al alloy	Non-aging treatment	500	60	4300-4800	
		Aging treatment	800	100	1500-1600	
Cast aluminum alloy	Non-aging treatment	750	75	1400-1500		
	Aging treatment	900	90	800-1000		
S	Heat resistant alloy	Iron base	Anneal	3000	200	100-150
			Aging	3050	280	90-110
		Ni- or Co- base	Anneal	3500	250	50-80
Aging	4150		350	30-60		
		Casting	4150	320	30-50	
H	Hardened steel	Hardened steel	4500	HRC55	130-160	

Note: •The values in the above table are range values. High values in the range could be considered in actual cutting. When trying new cutting speed, please check the cutting edge condition before operation.
 •In stainless steel threading, high cutting speed should be used to prevent built-up edge.
 •The cutting parameters should be reduced when cutting small pitch thread and when using tools with small nose radius.
 •When cutting thread by tools with small nose radius, such as NPT standard thread, it is advisable to use tools with big nose radius first to rough, so as to improve the life of tools with small nose radius.

In-feed way of threading tools

Radial in-feed

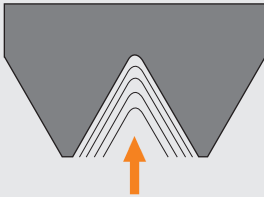

- Easy operating, high general.
- V-shape chip caused by long chip steel workpiece will produce big bend stress on cutting edge.
- It requires low cutting depth, sharp cutting edge and good tough material.
- Big quantity of heat when cutting ,V-shape chip is hard to control.
- Because the interface of cutting chips on the right and left side is long, so it is easy to cause vibration and make the cutting edge suffer more overloading.

Flank in-feed



- Cutting edge suffer small bend stress, stable estate, it is easy for chips formation in deep cutting depth.
- There are enough space to leave chips flow when flank in-feed.
- Big abrasion on right flank.

Modified flank in-feed

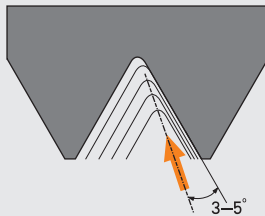

- Right Cutting Edge also engage on cutting depth to a certain extent, it can reduce the abrasion on right side of clearance face.
- Cutting edge suffer small bend stress, stable estate, it is easy for chips formation in deep cutting depth.
- Good Cutting Performance.

Alternate flank in-feed

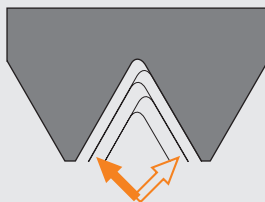

- Cutting edge trade off when machining, equality abrasion on left and right side of clearance face on cutting edge, it can improve the life of tools.
- Chips are flowing from both of right and left side, good chips flowing.
- Recommend using in big screw-pitch thread cutting.



Recommend adopting flank in-feed or alternate flank in-feed under allowable range of machining equipment or programmer, it can eliminate the machining vibration effectively, and it has enough space discharge the chips between pitch. Cutting edge suffer a small stress, machining stable, it likes the general turning process when machining thread, good chip control without extra chips.

Common problems in threading and solutions

Problem	Cause	Solutions
Wear on clearance face	Cutting speed too high.	Reduce cutting speed.
	Low cutting depth, abrasion.	Reduce frequency of feed and friction of cutting edge.
	Inserts are over the center line.	Adopt correct center height.
Asymmetric wear on right and left cutting edge	The inclined angle of insert is different from the helical angle of thread.	Change to proper shim to get correct inclined angle.
	Flank in-feed is not correct.	Change the way of flank in-feed.
Breakage	Cutting speed too low.	Increase cutting speed.
	Cutting force too high.	Increase frequency of feed and reduce Max in-feed.
	Unstable clamping.	Check if workpiece vibrates. Reduce overhang of tool. Verify clamping of workpiece and tool.
	Chip twisting.	Increase the pressure of cooling liquid to blow away chips.
Plastic deformation	High cutting speed, high temperature on cutting area.	Reduce cutting speed. Increase feed frequency and reduce Max cutting depth.
	Insufficient cooling fluid.	Increase cooling fluid supply.
Low thread surface quality	Cutting speed too low. The insert is over the center line. Chips are not under control.	Increase cutting speed. Adjust centre height. Change the operation way of tools to well control chips.
Incorrect profile	Incorrect center height.	Adjust centre height.
	Pitch on machine is not correct.	Adjust machine.
Shallow profile	Cutting speed set wrong.	Adjust cutting depth.
Surface damage	Chips involved or contacted.	Change to flank in-feed to control chip flow direction.
Built-up edge	Temperature of cutting edge is too low. Usually occur when machining stainless steel and low carbon steel.	Increase cutting speed as well as pressure and concentration of cooling fluid. Choose inserts with good toughness.
Crack on surface	Cutting force too high	Reduce the cutting depth of each feed.
Vibration	Incorrect clamping of workpiece or tool	Verify clamping of workpiece and tool. Minimize overhang of tool.
	Incorrect cutting parameters	Increase cutting speed or reduce it substantially.
	Incorrect tool clamping	Adjust center height.

Milling Tools

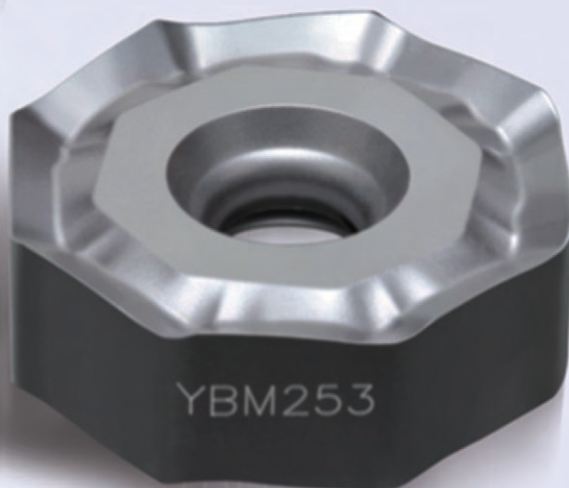
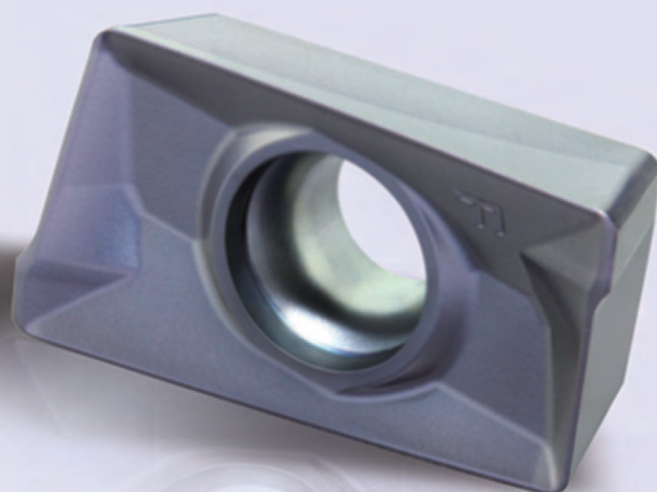
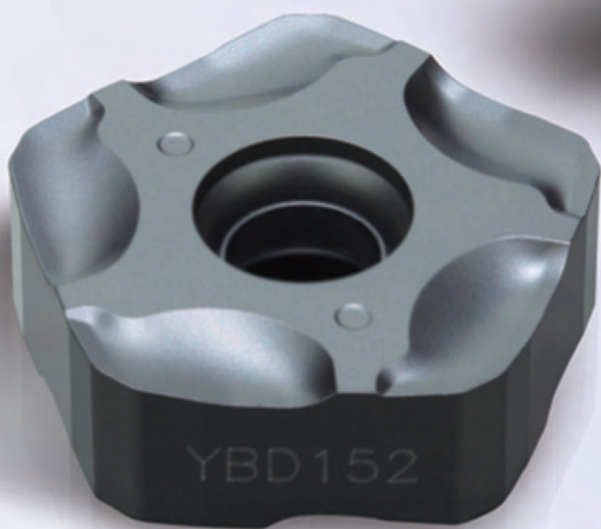





FMA11-100-B32-SN15-07
70022168

16.0xM13

V120T









YBM253





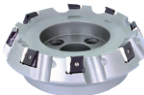

Milling

MILLING TOOLS

Overview	P188-192
Recommended grades for milling inserts	P193-195
Milling tools code key	P196-197
Face milling tools	P198-250
Square shoulder milling tools	P251-267
Profile milling tools	P268-273
High feed milling cutters	P274-280
Chamfer milling tools	P281-283
Common problems and solutions for milling	P284



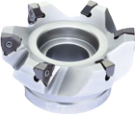

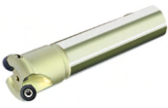
● Face milling tools

Operating pattern	Series/Shape	Approach angle / Max. cutting depth.(inch)	Applicable insert	Application overview	Features
Face milling	FMA01  P198	$K_r=45^\circ$ $a_{pmax}=0.236$	SEET12T3-DF/DM/DR SEET12T3-CF/CM/CR SEET12T3-EF/EM SEET12T3-LH/W	General face milling the following material: Steel, alloy steel, stainless steel, cast iron, aluminium alloy, high temperature alloy	<ul style="list-style-type: none"> • Diameter range $\varnothing 2.00''\sim\varnothing 10.00''$ • Large rake angle designed makes cutting more light and fast • Wide applications can achieve using available inserts with different chipbreaker • Adopting wiper inserts improve surface quality
		$K_r=45^\circ$ $a_{pmax}=0.384$	SEET18T6-DM		
	FMA02  P199	$K_r=45^\circ$ $a_{pmax}=0.236$	SEET12T3-DF/DM/DR SEET12T3-CF/CM/CR SEET12T3-EF/EM SEET12T3-LH/W	General face milling the following material: Steel, alloy steel, stainless steel, cast iron, aluminum alloy, high temperature alloy	<ul style="list-style-type: none"> • Diameter range $\varnothing 2.00''\sim\varnothing 5.00''$ • Large rake angle designed makes cutting more light and fast • Wide applications can achieve using available inserts with different chipbreaker • Coarse and differential pitch, reduce vibration.
		$K_r=45^\circ$ $a_{pmax}=0.295$	SE□N1203AF□□ SE□R1203AF□□ SE□N1504AF□□ SE□R1504AF□□		
	FMA03  P202	$K_r=45^\circ$ $a_{pmax}=0.217$	SE□N1203AF□□ SE□R1203AF□□	General face milling steel, stainless steel, cast iron	<ul style="list-style-type: none"> • Diameter range $\varnothing 3.00''\sim\varnothing 12.00''$ • Large rake angle makes cutting more light and fast • Top clamping achieves better reduces vibrations resistance
		$K_r=45^\circ$ $a_{pmax}=0.295$	SE□N1504AF□□ SE□R1504AF□□		
	FMA04  P205  P208	$K_r=45^\circ$ $a_{pmax}=0.138$	OFKT05T3-DF/DM OFKT05T3-LH	Face milling steel, alloy steel, cast iron, aluminum alloy	<ul style="list-style-type: none"> • Diameter range $\varnothing 2.00''\sim\varnothing 6.00''$ • High economy milling tool with 8 cutting edges • Screw clamping, high precision
		$K_r=45^\circ$ $a_{pmax}=0.197$	OFKR0704-DF/DM		
	FMA11  P212-213	$K_r=45^\circ$ $a_{pmax}=0.216$	SNEG1205ANR-GM/HGR/W	General face milling steel, stainless steel, cast iron	<ul style="list-style-type: none"> • Diameter range $\varnothing 2.00''\sim\varnothing 12.00''$; • Double-sided chipbreaker milling insert has eight cutting edges and high economy; • Large rake angle design and unique chip breaker structure of insert lead to low power consumption; • Double negative rake angle structure and super thick insert has higher safety and outstanding toughness, which can realize great depth cutting; • Insert has excellent machining performance with wiper edge.
		$K_r=45^\circ$ $a_{pmax}=0.275$	SNEG1506ANR-GM/HGR/W		
$K_r=45^\circ$ $a_{pmax}=0.354$		SNEG1907ANR-HGR			
FMA12  P217	$K_r=45^\circ$ $a_{pmax}=0.197$	ONHU08T624R-GM	General face milling steel, stainless steel, cast iron	<ul style="list-style-type: none"> • Diameter range $\varnothing 2.50''\sim\varnothing 12.00''$; • High Performance Face Mill with 16 edges for outstanding economy • Double negative rake angle, in combination with helical insert structure, achieves double positive axial angle, which will help reduce cutting resistance and improve chip evacuation. • Unique 3-dimensional edge 	
FMD02  P220-221	$K_r=67^\circ$ $a_{pmax}=0.197/0.276$	PNEG110512R/L-CF/CM/CR PNEG110512R/L-PF/PM/PR	Face milling of cast iron and steel	<ul style="list-style-type: none"> • Diameter range $\varnothing 2.00''\sim\varnothing 12.00''$ • High-economy milling tool with 10 cutting edges 	
FMD03  P224	$K_r=60^\circ$ $a_{pmax}=0.472$	LNKT2007DN-ZR	Heavy-duty face milling of steel and alloy steel	<ul style="list-style-type: none"> • Diameter range $\varnothing 5.00''\sim\varnothing 12.00''$. • Double positive rake angles can reduce cutting forces. • Inserts are mounted upright, suitable for heavy machining with high cutting depth. • Easy to assemble and clamp inserts. 	
	$K_r=60^\circ$ $a_{pmax}=0.669$	LNKT2510-ZR			



Operating pattern	Series/Shape	Approach angle / Max. cutting depth. (inch)	Applicable insert	Application overview	Features
Face milling	FMD04  P226	$Kr=67^\circ$ $a_{pmax}=0.472$	PNGU170712R-GR	Rough milling of steel and cast iron	<ul style="list-style-type: none"> Diameter range $\varnothing 5.00''$-$\varnothing 12.00''$ High-economy milling tool with 10 cutting edges Double negative rake angle, in combination with helical insert structure, achieves double positive axial angle, which will help reduce cutting resistance and improve chip evacuation.
	FME04  P228	$Kr=75^\circ$ $a_{pmax}=0.472$	LNKT1506EN-ZR	Heavy-duty face milling of steel and alloy steel	<ul style="list-style-type: none"> Diameter range $\varnothing 5.00''$-$\varnothing 12.00''$. Double positive rake angles can reduce the cutting force. Inserts are mounted upright, suitable for heavy machining at high cutting depth. Easy to assemble and clamp inserts.
	FMP01  P230	$Kr=90^\circ$ $a_{pmax}=0.709$	TP□N2204PD□ TPKN2204PDF□ TPKN2204PDT□	Face milling steel, alloy steel and cast iron	<ul style="list-style-type: none"> Diameter range $\varnothing 3.00''$-$\varnothing 12.00''$ $Kr 90^\circ$, square shoulder milling Top clamping is easy to assemble and disassemble
	FMP02  P232	$Kr=90^\circ$ $a_{pmax}=0.285$	SEET09T308PER-APF/APM SEET120308PER-APR	Face milling steel, alloy steel, stainless steel and cast iron	<ul style="list-style-type: none"> Diameter range $\varnothing 2.00''$-$\varnothing 10.00''$ $Kr 90^\circ$, for square shoulder millin Different pitch design: coarse pitch, close pitch and extra close pitch High precision insert, high work-piece surface quality Optimized chipbreaker and grade, for finish machining, semi-finish machining and rough machining.
		$Kr=90^\circ$ $a_{pmax}=0.425$	SEET120308PER-APF/APM SEET120308PER-APR		
	FMP03  P235	$Kr=90^\circ$ $a_{pmax}=0.512$	LNKT1506EN-ZR	Heavy-duty face milling of steel and alloy steel	<ul style="list-style-type: none"> Diameter range $\varnothing 5.00''$-$\varnothing 12.00''$. Double positive rake angles can reduce the cutting force. Inserts are mounted upright, suitable for heavy machining at high cutting depth. Easy to assemble and clamp inserts.
		$Kr=90^\circ$ $a_{pmax}=0.669$	LNKT2007DN-ZR		
		$Kr=90^\circ$ $a_{pmax}=0.866$	LNKT2510-ZR		
	FMP12  P237	$Kr=90^\circ$ $a_{pmax}=0.224$	WNHU060404PNR-GM WNHU060408PNR-GM	Steel, alloy steel, cast iron	<ul style="list-style-type: none"> Diameter range $\varnothing 2.00''$-$\varnothing 6.00''$ 90° approach angle can be used for shoulder milling, face milling, groove milling, etc.; -Six-flute double-sided groove milling inserts with wiper for large feed machining; double negative angle of the tool body combined with unique insert structure to achieve double positive tool angle, reducing cutting forces.
$Kr=90^\circ$ $a_{pmax}=0.303$		WNHU080608PNR-GM WNHU080616PNR-GM			
FMP12  P238	$Kr=90^\circ$ $a_{pmax}=0.224$	WNHU060404PNR-GM WNHU060408PNR-GM		<ul style="list-style-type: none"> Diameter range $\varnothing 1.00''$-$\varnothing 2.00''$ 90° approach angle can be used for shoulder milling, face milling, groove milling, etc.; -six-flute double-sided groove milling inserts with wiper for large feed machining; Double negative angle of cutter body combined with unique insert structure to achieve double positive tool angle, reducing cutting forces. 	
FMR01  P240	$a_{pmax}=0.197$	RCKT10T3MO-DM	Cavity profile milling steel, alloy steel, stainless steel and cast iron	<ul style="list-style-type: none"> Diameter range $\varnothing 1.00''$-$\varnothing 2.00''$ R-type inserts possess stronger cutting edges Suitable for machining curved surface of mould Economical milling cutters with screw clamping 	
	$a_{pmax}=0.236$	RCKT1204MO-DM/DR/ER			







● Face milling tools

Operating pattern	Series/Shape	Approach angle / Max. cutting depth. (inch)	Applicable insert	Application overview	Features
Face milling	FMR02  P242	$a_{pmax}=0.236$	RCKT1204MO-DM/DR/ER/NM	Face milling and cavity profile milling steel, alloy steel, stainless steel and cast iron	<ul style="list-style-type: none"> • Diameter range $\varnothing 2.50''\sim\varnothing 6.00''$ • R-type inserts possess stronger cutting edges • Suitable for machining curved surface of mould • Economical milling tools with screw clamping
		$a_{pmax}=0.315$	RCKT1606MO-DM/DR/ER/NM		
		$a_{pmax}=0.394$	RCKT2006MO-DR/ER/NM		
	FMR03  P244	$a_{pmax}=0.157$	RDKW0803MO	Cavity profile milling steel, alloy steel, stainless steel and cast iron	<ul style="list-style-type: none"> • Diameter range $\varnothing 1.00''\sim\varnothing 2.00''$ • R-type inserts possess stronger cutting edges • Suitable for machining curved surface of mould • Economical milling tools with screw clamping
		$a_{pmax}=0.197$	RDKW10T3MO		
		$a_{pmax}=0.236$	RDKW1204MO		
Face milling	FMR04  P246	$a_{pmax}=0.236$	RDKW1204MO	Face milling and cavity profile milling steel, alloy steel, stainless steel and cast iron	<ul style="list-style-type: none"> • Diameter range $\varnothing 2.00''\sim\varnothing 6.00''$ • R-type inserts possess stronger cutting edges • Suitable for machining curved surface of mould
		$a_{pmax}=0.315$	RDKW1605MO		
		$a_{pmax}=0.394$	RDKW2006MO		
	FMR05  P248	$a_{pmax}=0.125$	RPMW2T200	Cavity profile milling steel, alloy steel, stainless steel and cast iron	<ul style="list-style-type: none"> • Diameter range $\varnothing 0.625''\sim\varnothing 1.75''$ • R-type inserts possess stronger cutting edges • Suitable for machining curved surface of mould • Economical milling cutters with screw clamping
		$a_{pmax}=0.180$	RPMW3T300		
		$a_{pmax}=0.250$	RPMW40400		
	 P249	$a_{pmax}=0.250$	RPMW40400	Face milling and cavity profile milling steel, alloy steel, stainless steel and cast iron	<ul style="list-style-type: none"> • Diameter range $\varnothing 2.00''\sim\varnothing 8.00''$ • R-type inserts possess stronger cutting edges • Suitable for machining curved surface of mould • Economical milling tools with screw clamping
		$a_{pmax}=0.315$	RPMW50500		
		$a_{pmax}=0.375$	RPMW60600		



● Square shoulder milling tools

Operating pattern	Series/Shape	Approach angle / Max. cutting depth. (inch)	Applicable insert	Application overview	Features
Square shoulder milling	EMP01  P251-252	$Kr=90^\circ$ $a_{pmax}=0.433$	APKT11T3□□-APF/APM APKT11T3□□-ALH	Multi-function milling steel, alloy steel, stainless steel, cast iron and Al alloy	<ul style="list-style-type: none"> • Two mounting modes: Straight shank and Weldon shank, Diameter range $\varnothing 0.50''\sim\varnothing 2.50''$ • $Kr 90^\circ$, for square shoulder milling, slot milling, ramp milling etc. • Wiper inserts also suitable for face milling. • Inserts with 3D helical cutting edge, less cutting force
		$Kr=90^\circ$ $a_{pmax}=0.630$	APKT160408-APF/APM APKT160408-ALH		
	EMP02  P257	$Kr=90^\circ$ $a_{pmax}=0.433$	APKT11T3□□-APF/APM APKT11T3□□-ALH	Face milling steel, alloy steel, stainless steel, cast iron and Al alloy	<ul style="list-style-type: none"> • Diameter range $\varnothing 2.00''\sim\varnothing 8.00''$ • $Kr 90^\circ$, for square shoulder milling • Wiper inserts also suitable for face milling. • Inserts with 3D helical cutting edge, less cutting force
		$Kr=90^\circ$ $a_{pmax}=0.630$	APKT160408-APF/APM APKT160408-ALH		





Operating pattern	Series/Shape	Approach angle / Max. cutting depth.(inch)	Applicable insert	Application overview	Features
Square shoulder milling	EMP03  P260	$Kr=90^\circ$ $a_{pmax}=1.535$	APKT11T3□□-APF/APM APKT11T3□□-ALH	Adopting large cutting depth, for milling steel, alloy steel, stainless steel, cast iron and Al alloy	<ul style="list-style-type: none"> • Diameter range $\varnothing 2.00''\sim\varnothing 4.00''$ • End milling tools with positive helical angle, good chip removal • For side face milling and slot machining • Close pitch, high machining efficiency.
	EMP04  P261	$Kr=90^\circ$ $a_{pmax}=1.157\sim 2.283$	APKT11T3□□-APF/APM APKT11T3□□-ALH	Adopting large cutting depth, for milling steel, alloy steel, stainless steel, cast iron and Al alloy	<ul style="list-style-type: none"> • Diameter range $\varnothing 0.75''\sim\varnothing 1.50''$ • End milling tools with positive helical angle, good chip removal • For side face milling and slot machining • Close pitch, high machining efficiency.
	EMP13  P265	$Kr=90^\circ$ $a_{pmax}=0.441$	ANGX1105□□PNR-GM/LH	Face milling steel, alloy steel, stainless steel and cast iron	<ul style="list-style-type: none"> • Diameter range $\varnothing 2.00''\sim\varnothing 6.00''$ • $Kr 90^\circ$, for square shoulder milling • Double negative rake angle of the tool body in combination with extra thick insert achieves double positive tool angle, which will help reduce cutting resistance and greatly improve impact resistance. • Properly designed cutting edge with high precision control can achieve high quality 90square shoulder milling.
		$Kr=90^\circ$ $a_{pmax}=0.571$	ANGX1506□□PNR-GM/LH		
EMP13  P266	$Kr=90^\circ$ $a_{pmax}=0.441$	ANGX1105□□PNR-GM/LH	Multi-function milling steel, alloy steel, stainless steel and cast iron	<ul style="list-style-type: none"> • Two mounting modes: Straight shank and Weldon shank, Diameter range $\varnothing 0.75''\sim\varnothing 1.50''$ • $Kr90^\circ$, for square shoulder milling, slot milling, ramp milling ect. • Double negative rake angle of the tool body in combination with extra thick insert achieves double positive tool angle, which will help reduce cutting resistance and greatly improve impact resistance. • Properly designed cutting edge with high precision control can achieve high quality 90square shoulder milling. 	
	$Kr=90^\circ$ $a_{pmax}=0.571$	ANGX1506□□PNR-GM/LH			





Profile milling tools

Operating pattern	Series/Shape	Approach angle / Max. cutting depth.	Applicable insert	Application overview	Features
Profile milling	BMR02  P268	Cutting depth: see the detailed information about tool specifications	ROHX□□	Profile machining steel, stainless steel and cast iron	<ul style="list-style-type: none"> • Diameter range $\varnothing 0.472''\sim\varnothing 0.787''$ • Applied for profile finish machining. • Good assembly stability. • Insert with two cutting edges, perfect economical efficiency.
	BMR04  P270		ZOHX□□	Profile machining steel, stainless steel and cast iron	<ul style="list-style-type: none"> • Diameter range $\varnothing 0.625''\sim\varnothing 1.25''$ • High precision, for finish profile machining. • Two types of chipbreaker, used in different machining condition. • High assembling precision, good stability.

● Special milling tools

Operating pattern	Series/Shape	Approach angle / Max. cutting depth.	Applicable insert	Application overview	Features
Special milling (high feed)	 P274	Cutting depth: see the detailed information about tool specifications	SDMT□□-DM/PM/NM	Face and profile milling steel, stainless steel and cast iron in cavity applications	<ul style="list-style-type: none"> • Diameter range $\varnothing 0.75'' \sim \varnothing 6.00''$ • Two mounting types: Straight shank and Arbor mounting • The cutting forces are decomposed effectively, realize cutting with high feed rate. • For plunge milling • Double clamping, firm and reliable.
	 P275				
	 P277		WPGT□□ZSR WPGT□□ZSR-PM	Face and profile milling steel, stainless steel and cast iron in cavity applications	<ul style="list-style-type: none"> • Diameter range $\varnothing 0.75'' \sim \varnothing 4.00''$ • Two mounting types: Straight shank and Arbor mounting • The cutting forces are decomposed effectively, realize cutting with high feed rate. • Double clamping, firm and reliable.
	 P278				

● Chamfer milling tools



Operating pattern	Series/Shape	Approach angle / Max. cutting depth.	Applicable insert	Application overview	Features
Chamfer machining	 P281	Kr=45°	SPMT120408	Chamfer machining steel, alloy steel, stainless steel and cast iron	<ul style="list-style-type: none"> • Diameter range $\varnothing 0.50'' \sim \varnothing 1.25''$ • With the function of milling small surface.
	 P282	Kr=60°			

Milling insert grades overview

ISO	Coated grade		Coated cermet	Cemented carbide	PCBN&PCD
	CVD	PVD			
P Steel	P01				
	P10		YBG202 YBG205 YB9320 YBG252	YNG151 YNG151C	
	P20	YBC302 YBM251			
	P30	YBM351			YC30S
	P40		YBG302		
M Stainless steel	M01				
	M10	YBM251 YBM253 YBC302 YBM351	YBG202 YBG205 YB9320 YBG252	YNG151 YNG151C	
	M20				
	M30		YBG302		YC30S
	M40				
K Cast iron	K01				YCB01I
	K10	YBD151 YBD152	YBG102 YBG102 YBG152 YBG252	YNG151 YNG151C YD051	
	K20				YD201
	K30	YBD252			
	K40				
N Non-ferrous metal	N01				YCD011
	N10			YD101	
	N20			YD201	
	N30				
S Heat-resistant steel	S01				
	S10		YBG202		
	S20				
	S30				
H Hardened material	H01				YCB012
	H10				
	H20				
	H30				

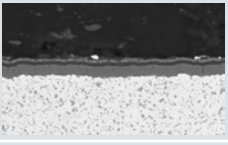
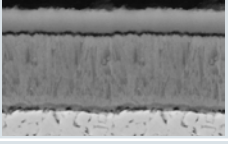
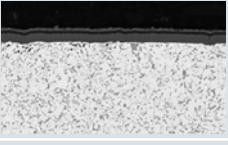

Coated Cemented Carbide CVD

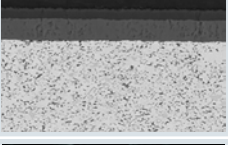
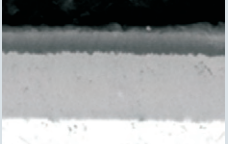
Grade	Coating structure	Micro-structure	ISO applied range	Application field
YBM251	Combination of high toughness and strength substrate and the coating comprised of TiCN, thin Al ₂ O ₃ , TiN		P15~40	Applicable for semi-finish and rough milling P, M type materials
			M10~30	
YBM253	Combination of high-toughness gradient substrate and coating composed of TiCN and ultra fine Al ₂ O ₃		M10~30	Suitable for rough milling of M-type material
YBM351	Combination of high toughness substrate and the coating composed of TiCN, thin Al ₂ O ₃ , TiN		P25~40	Applicable for rough milling P, M type materials
			M20~35	
YBD152	Good combination of substrate with high wear-resistance and coating composed of TiCN and thick Al ₂ O ₃		K05~25	Suitable for finish and semi-finish milling of K-type material
YBD252	Good combination of substrate with high wear-resistance and coating composed of TiCN and thick Al ₂ O ₃		K15~35	Suitable for rough and semi-finish milling of K-type material
YBC302	Combination of high toughness, high strength substrate and coating composed of TiCN, thin Al ₂ O ₃ and TiN.		P15~35	Suitable for rough and semifinish milling of P-type, M-type, whose hardness is below HRC45 and under.
			M10~30	

Coated Cemented Carbide PVD

Grade	Coating structure	ISO applied range	Application field
YBG102	Fine grain carbide substrate+Nano coating	K05~20	Applicable for finish and semi-finish milling K type material
YBG202	Carbide substrate with excellent deformation resistance +Nano coating	P10~30	PVD grade with wide application, widely applicable for semifinish milling type P, M, S materials
		M10~30	
		S05~20	
YBG205	Ultra fine carbide substrate + Nano coating	M10~30	Suitable for rough milling of M-type material
YBG302	Substrate with high toughness and strength + Nano-coating	P25~40	Applicable for rough milling type P and M materials
		M25~40	
YBG152	Substrate with reasonable hardness and strength + Nano coating	K20~35	Applicable for rough and semi-finish milling type K material
YB9320	Substrate with good toughness and strength +TiAlN Nano coating	P10~30	PVD grade with wide application, widely applicable for semifinish milling type P, M materials
		M10~30	

● Cermet

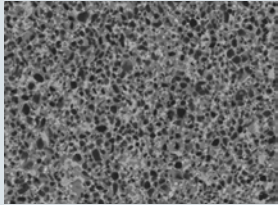
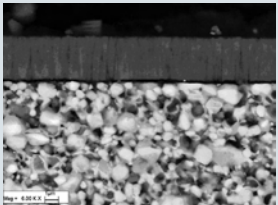
Grade	Coating structure	ISO applied range	Application field
YNG151		P05~20	Wide application of finish milling P, M, K type materials
		M05~20	
		K05~20	
YNG151C		P01~20	Wide application of finish milling P, M, K type materials
		M01~20	
		K01~20	

● Cemented Carbide

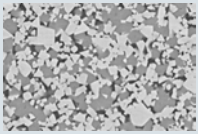
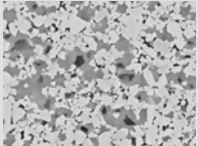
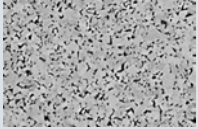
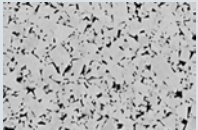
Grade	Coating structure	ISO applied range	Application field
YC30S		P25~40	Applicable for roughing milling Code P, M type materials
		M25~40	
YD051		K05~20	Applicable for finishing milling type K material
YD101		N05~25	Applicable for semi-finish and finish milling type N material
YD201		K15~35	Applicable for rough and semi-finish type K material, and for rough milling type N material
		N15~30	

Cutter type	
FM	Face milling
EM	Square shoulder milling
HM	Helical end milling
SM	Side and face milling
BM	Profile milling
CM	Chamfer milling
XM	Special milling

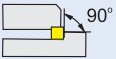
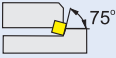
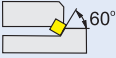
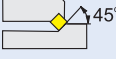
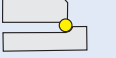
Approach angle		
P	90°	
E	75°	
D	60°	
A	45°	
R		

Sequence number of series

Cutting diameter $\varnothing D$

Side and face milling tool: diameter
X cutting edge width

Arbor/spindle Mounting
(as follow figure)







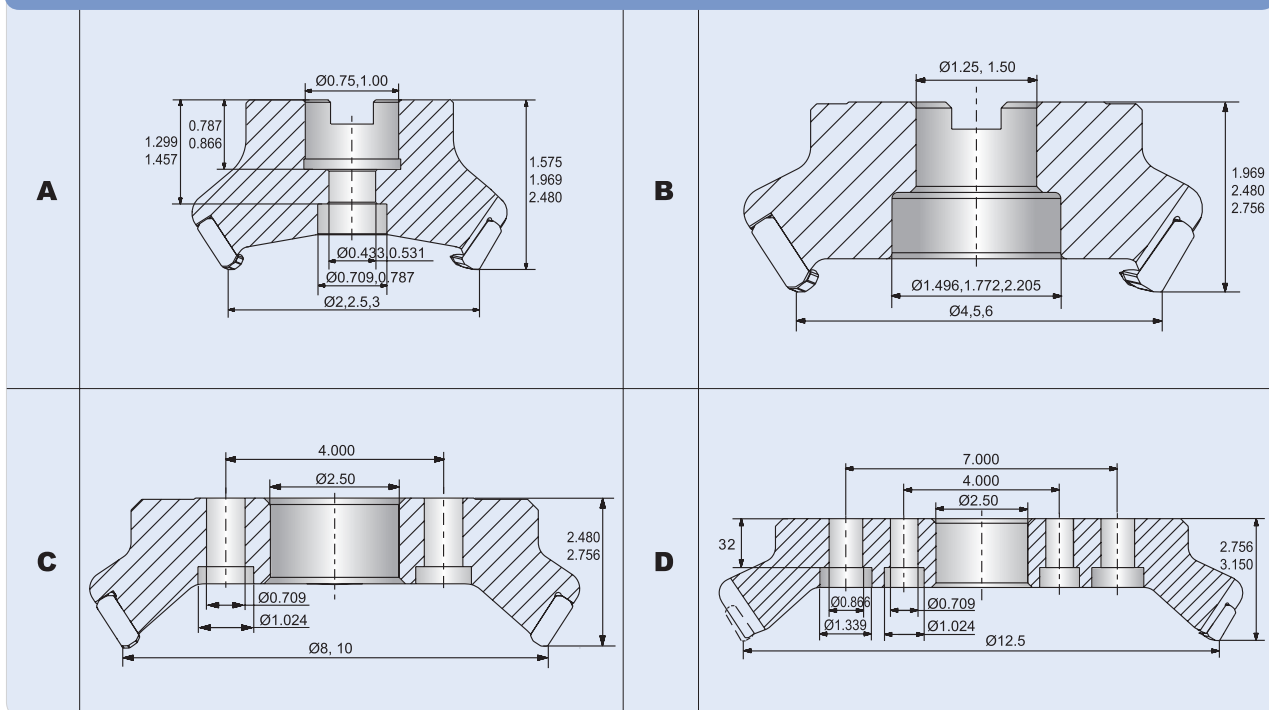

A	A type of mounting	XP	Weldon shank
B	B type of mounting	G	Straight shank
C	C type of mounting	MW	Morse adapter with a conical hole and without a flat end
D	D type of mounting		

FM A 02 - 2.00" - A

Arbor/spindle Mounting



Arbor hole size(inch)
(as follow figure)

Insert shape			
 C	 D	 R	 S
 T	 L	 H	 O

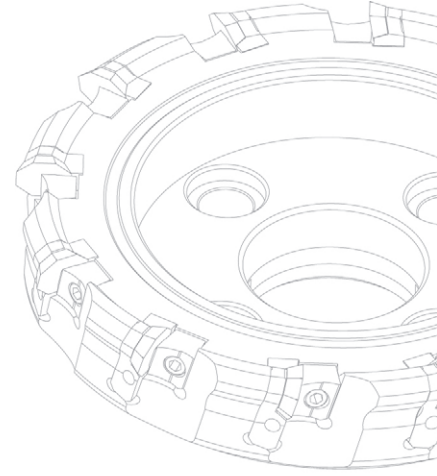

Insert clearance angle

N	B	C	P	D	E	F
0°	5°	7°	11°	15°	20°	25°

0.75"

S

E

12-04

C

D

Cutting edge length of insert

Inscribed circle	Insert shape					
	C	D	R	S	T	L
0.219	—	—	—	—	09	—
0.250	06	07	—	—	11	—
0.375	09	11	09	09	16	—
0.500	12	15	12	12	22	—
0.625	16	19	15	15	27	—
0.750	19	—	19	19	33	—
1.000	25	—	25	25	44	2

Number of teeth

(number of flute for corn-shaped milling tools)

Cutting direction

(Default:Right L:left)

Internal cooling structure

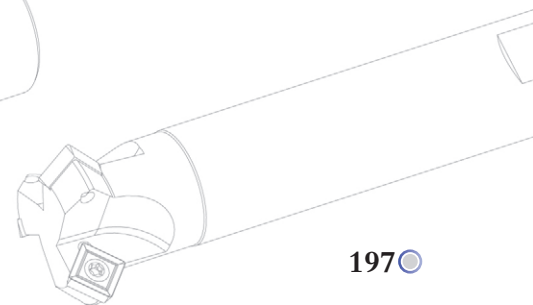
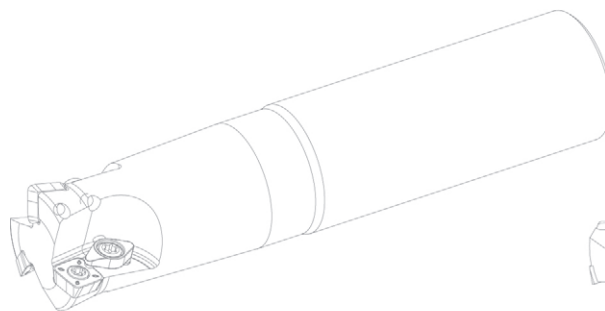

Face milling tools

Kr:45°



FMA01 P M K N S



Close pitch

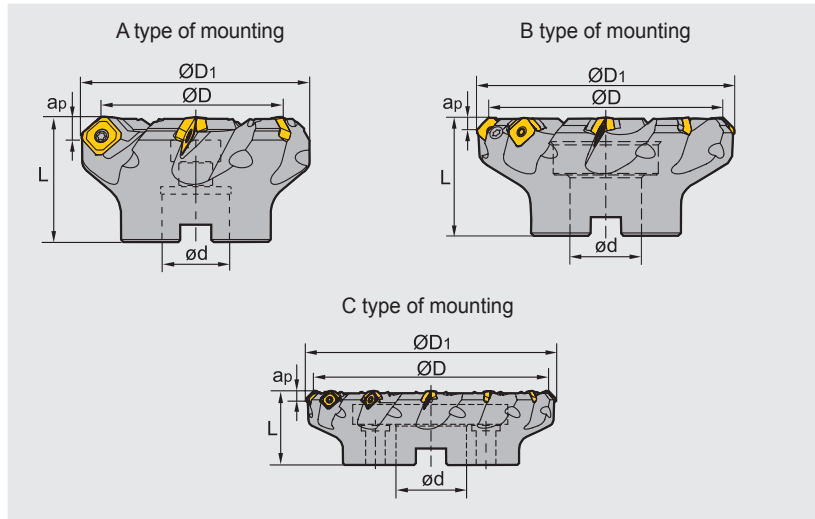

Specification of tools

Type		Dimensions (inch)						
		ØD	ØD1	ød	L	ap _{max}	Z	Interface form
FMA01	-2.00"-A0.75"-SE12-04	2.000	2.510	0.750	1.500	0.236	4	A
	-2.50"-A0.75"-SE12-05	2.500	3.010	0.750	1.500	0.236	5	A
	-3.00"-A1.00"-SE12-06	3.000	3.510	1.000	2.000	0.236	6	A
	-4.00"-B1.25"-SE12-07	4.000	4.510	1.250	2.000	0.236	7	B
	-4.00"-B1.25"-SE18-04	4.000	4.510	1.250	2.500	0.384	4	B
	-5.00"-B1.50"-SE12-08	5.000	5.510	1.500	2.500	0.236	8	B
	-5.00"-B1.50"-SE18-05	5.000	5.510	1.500	2.500	0.384	5	B
	-6.00"-B1.50"-SE12-10	6.000	6.510	1.500	2.500	0.236	10	B
	-6.00"-B1.50"-SE18-06	6.000	6.510	1.500	2.500	0.384	6	B
	-8.00"-C2.50"-SE12-12	8.000	8.510	2.500	2.500	0.236	12	C
	-8.00"-C2.50"-SE18-08	8.000	8.510	2.500	2.500	0.384	8	C
	-10.0"-C2.50"-SE12-14	10.000	10.510	2.500	2.500	0.236	14	C

Spare parts

Diameter ØD	Insert specification	Insert screw	Shim	Shim screw	Wrench	Wrench	Sketch of installation
Ø2", Ø2.5" Ø3", Ø4"	SEET12T3-□□	I60M3.5×10	--	--	WT15IS	--	
Ø5", Ø6" Ø8", Ø10"	SEET12T3-□□	I60M3.5×12	S13BS	SM5×7XA		WH35L	
Ø4"~Ø8"	SEET18T6-DM	I60M5×17	S18BS	SM8×9XA	WT20IT	WH50L	

Face milling tools **Kr:45°**



FMA02 **P M K N S**



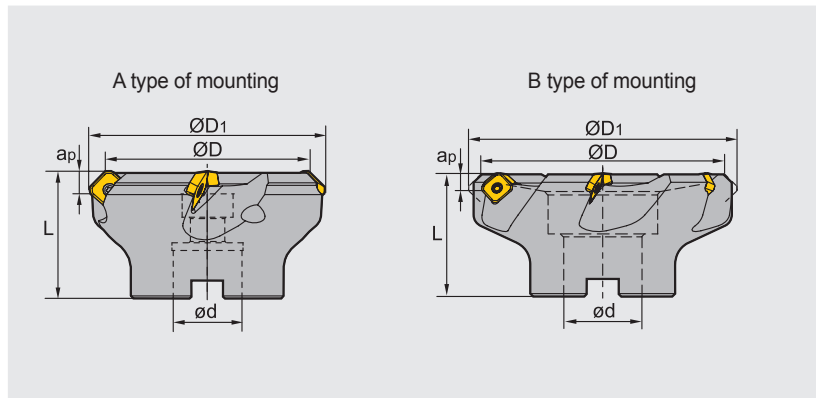

Coarse pitch differential



Specification of tools

Type		Dimensions(inch)						
		ØD	ØD ₁	Ød	L	ap _{max}	Z	Interface form
FMA02	-2.00"-A0.75"-SE12-04	2.000	2.510	0.750	1.500	0.236	4	A
	-2.50"-A0.75"-SE12-05	2.500	3.010	0.750	1.500	0.236	5	A
	-3.00"-A1.00"-SE12-05	3.000	3.510	1.000	2.000	0.236	5	A
	-4.00"-B1.25"-SE12-07	4.000	4.510	1.250	2.000	0.236	7	B
	-5.00"-B1.50"-SE12-08	5.000	5.510	1.500	2.500	0.236	8	B

Spare parts

Insert screw	Wrench	Sketch of installation
		
I60M3.5×10	WT15IS	

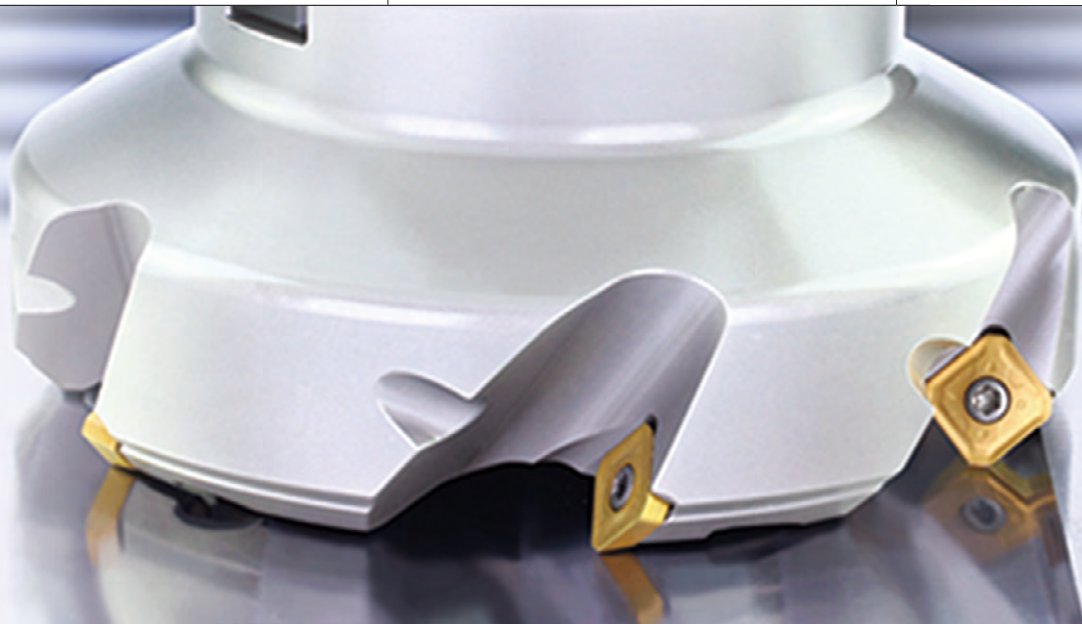

Selection of inserts

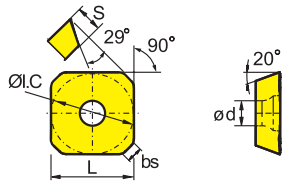

😊 Good working conditions 😐 General working conditions 😞 Adverse working conditions

Workpiece material	P Steel	M Stainless steel	K Cast iron	N Ferrite materials	S Heat-resistant steel
P Steel	😊	😊	😊	😊	😊
M Stainless steel	😊	😊	😊	😊	😊
K Cast iron	😊	😊	😊	😊	😊
N Ferrite materials	😊	😊	😊	😊	😊
S Heat-resistant steel	😊	😊	😊	😊	😊

Insert shape	Type	Dimensions (inch)						Coated grade										Cermet		Cemented carbide							
		L	ØI.C	S	ød	bs	R	YBC302	YBM251	YBM253	YBM351	YBD152	YBD252	YBG102	YBG202	YBG205	YB9320	YBG302	YBG152	YBG252	YNG151	YNG151C	YC30S	YD051	YD101	YD201	
	SEET12T3-DF	0.528	0.528	0.156	0.161	0.100		●	○							●		○									
	SEET12T3-CF	0.528	0.528	0.156	0.161	0.100						○	●		○		○										
	SEET12T3-EF	0.528	0.528	0.156	0.161	0.100									●		○										
	SEET12T3-DM	0.528	0.528	0.156	0.161	0.100		●	●							○	●										
	SEET18T6-DM	0.709	0.709	0.24	0.217	0.059	0.039	●		●						●											
	SEET12T3-CM	0.528	0.528	0.156	0.161	0.100						●				●		○									
	SEET12T3-EM	0.528	0.528	0.156	0.161	0.100			●		●					●		●									
	SEET12T3-DR	0.528	0.528	0.156	0.161	0.100		●			●					●		●									
	SEET12T3-CR	0.528	0.528	0.156	0.161	0.100						●				●		●									
	SEET12T3-LH	0.528	0.528	0.156	0.161	0.100			●																○	●	
	SEET12T3-W	0.702	0.528	0.156	0.161	0.372	19.685	●	●			●				●					●						

● Always stock available ○ Produce according to order

Chipbreaker selection for FMA01

Function Classification	For finishing	For semi-finishing	For roughing
P	-DF	-DM	-DR
M,S	-EF	-EM	
K	-CF	-CM	-CR
AL	-LH		

Recommended cutting parameters

Workpiece material	Hardness HB	Insert grade	Cutting parameters				
			V(SFPM)	f(in/z)			
				-DF	-DM	-DR	
P	Low-carbon steel, Soft steel	≤ 180	YBM251	900(700-1200)	0.006(0.004-0.008)	0.008(0.004-0.012)	0.012(0.008-0.016)
			YBC302	900(700-1200)	0.006(0.004-0.008)	0.008(0.004-0.012)	0.012(0.008-0.016)
			YBG205	900(650-1200)	0.006(0.004-0.008)	0.008(0.004-0.012)	0.012(0.008-0.016)
			YBG302	750(550-1200)	0.006(0.004-0.008)	0.008(0.004-0.012)	0.012(0.008-0.016)
	High-carbon steel, Alloy steel	180-280	YBM251	800(700-1000)	0.006(0.004-0.008)	0.008(0.004-0.012)	0.012(0.008-0.016)
			YBG205	800(600-1200)	0.006(0.004-0.008)	0.008(0.004-0.012)	0.012(0.008-0.016)
			YBG302	700(500-1100)	0.006(0.004-0.008)	0.008(0.004-0.012)	0.012(0.008-0.016)
	Alloy tool steel	280-350	YBM251	700(600-1000)	0.006(0.004-0.008)	0.008(0.004-0.012)	0.012(0.008-0.016)
			YBG205	700(550-1100)	0.006(0.004-0.008)	0.008(0.004-0.012)	0.012(0.008-0.016)
YBG302			600(400-1000)	0.006(0.004-0.008)	0.008(0.004-0.012)	0.012(0.008-0.016)	
M	Stainless steel	≤ 270			-EF	-EM	
			YBM251	500(400-800)	0.006(0.004-0.008)	0.008(0.004-0.012)	
			YBG205	500(360-900)	0.006(0.004-0.008)	0.008(0.004-0.012)	
			YBG302	450(300-800)	0.006(0.004-0.008)	0.008(0.004-0.012)	
K	Cast iron	180-250	YBG102	700(400-1000)	-CF	-CM	-CR
					0.006(0.004-0.008)	0.008(0.004-0.012)	0.012(0.008-0.016)
N	Al alloy steel	-	YD101	1000-	-LH		
			YD201	1000-	0.010(0.004-0.016)		
S	High-temperature alloy	≤ 400	YBG102	150(60-200)	-EF	-EM	
					0.004(0.004-0.008)	0.006(0.004-0.012)	



Face milling tools **Kr:45°**





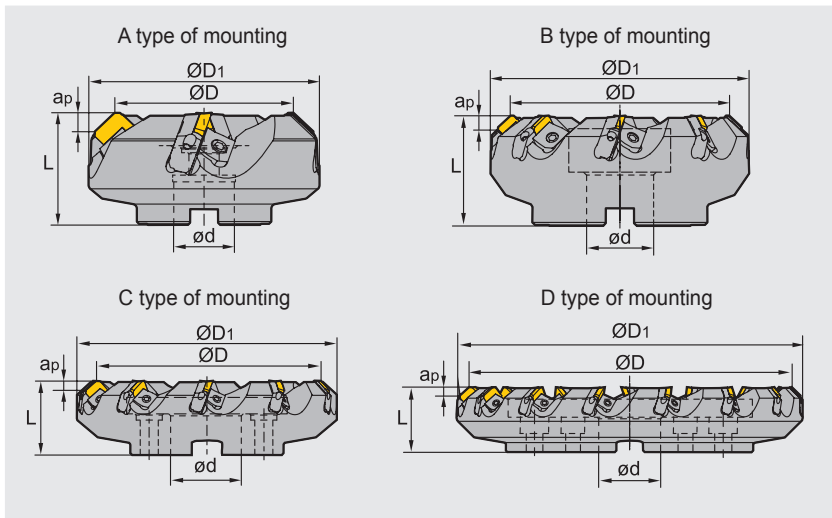



FMA03 P M K



Specification of tools

Type		Dimensions(inch)						
		ØD	ØD1	Ød	L	apmax	Z	Interface form
FMA03	-3.00"-A1.00"-SE12-04	3.000	3.858	1.000	2.000	0.217	4	A
	-4.00"-B1.25"-SE12-05	4.000	4.858	1.250	2.000	0.217	5	B
	-5.00"-B1.50"-SE12-06	5.000	5.858	1.500	2.500	0.217	6	B
	-6.00"-B1.50"-SE12-08	6.000	6.858	1.500	2.500	0.217	8	B
	-8.00"-C2.50"-SE12-10	8.000	8.858	2.500	2.500	0.217	10	C
	-10.0"-C2.50"-SE12-12	10.00	10.858	2.500	2.500	0.217	12	C
	-12.0"-D2.50"-SE12-15	12.00	12.858	2.500	2.500	0.217	15	D
	-3.00"-A1.00"-SE15-04	3.000	3.858	1.000	2.000	0.295	4	A
	-4.00"-B1.25"-SE15-05	4.000	4.858	1.250	2.000	0.295	5	B
	-5.00"-B1.50"-SE15-06	5.000	5.858	1.500	2.500	0.295	6	B
	-6.00"-B1.50"-SE15-08	6.000	6.858	1.500	2.500	0.295	8	B
	-8.00"-C2.50"-SE15-10	8.000	8.858	2.500	2.500	0.295	10	C
	-10.0"-C2.50"-SE15-12	10.00	10.858	2.500	2.500	0.295	12	C
	-12.0"-D2.50"-SE15-15	12.00	12.858	2.500	2.500	0.295	15	D

Spare parts

Locator	Wedge	Wedge screw	Locator screw	Wrench	Sketch of installation
 LSE 12R/L (Suitable for 12mm inserts) LSE 15R/L (Suitable for 15mm inserts)	 W01R/L	 DM8×21X	 LOM5×15.1	 WT20T WH40T	

Recommended cutting parameters

Workpiece material	Hardness HB	Insert grade	Cutting parameters		
			V(SFPM)	f(in/z)	
P	Low-carbon steel、 Soft steel	≤ 180	YNG151	1400 (1100 -1600)	0.008(0.004-0.016)
			YBM251	900 (700 -1100)	0.008(0.004-0.016)
			YBM351	700 (600 -1000)	0.01(0.006-0.012)
			YBG202	900 (650 -1200)	0.008(0.004-0.012)
			YC30S	450 (300 -700)	0.011(0.004-0.016)
	High-carbon steel、 Alloy steel	180—280	YNG151	1300 (1000 -1600)	0.008(0.004-0.016)
			YBM251	800 (650 -1000)	0.008(0.006-0.016)
			YBM351	650 (500 -900)	0.010(0.006-0.012)
			YBG202	800 (600 -1100)	0.008(0.004-0.012)
			YC30S	400 (260 -650)	0.011(0.004-0.016)
	Alloy tool steel	280—350	YNG151	1100 (1000 -1500)	0.008(0.004-0.016)
			YBM251	700 (600 -1000)	0.008(0.004-0.016)
			YBM351	600 (500 -800)	0.01(0.006-0.012)
			YBG202	700 (550 -1100)	0.008(0.004-0.012)
			YC30S	300 (200 -600)	0.011(0.004-0.016)
M	Stainless steel	≤ 270	YNG151	700 (500 -900)	0.008(0.004-0.016)
			YBM251	400 (300 -700)	0.008(0.004-0.016)
			YBM351	450 (300 -800)	0.01(0.006-0.012)
			YBG202	450 (300 -800)	0.008(0.004-0.012)
K	Cast iron	180-250	YBG102	700 (400 -1000)	0.008(0.004-0.012)
			YD201	300 (260 -500)	0.01(0.004-0.016)

D

M

K

Face milling tools **Kr:45°**



FMA04 **P** **M** **K** **N**



Screw clamping

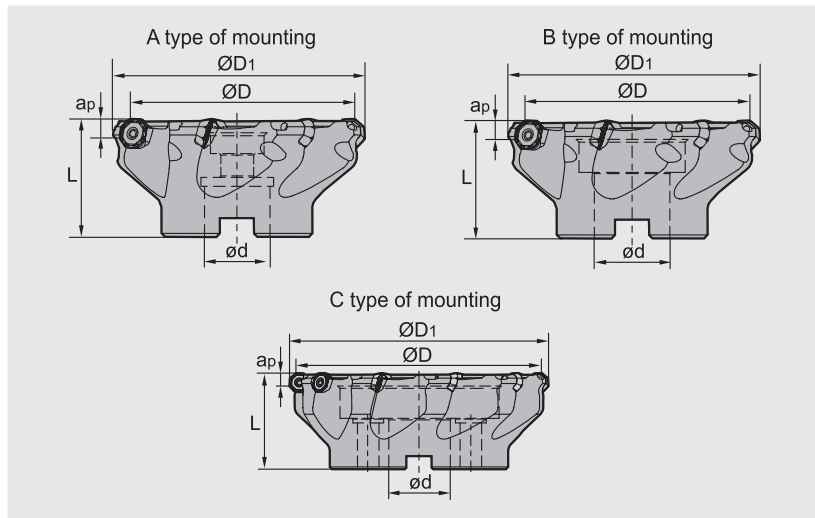

Specification of tools

Type		Dimensions(inch)						
		ØD	ØD1	ød	L	apmax	Z	Interface form
FMA04	-2.00" -A0.75" -OF05-04	2.000	2.356	0.750	1.500	0.138	4	A
	-2.00" -A0.75" -OF05-05	2.000	2.356	0.750	1.500	0.138	5	A
	-2.50" -A0.75" -OF05-05	2.500	2.856	0.750	2.000	0.138	5	A
	-3.00" -A1.00" -OF05-06	3.000	3.356	1.000	2.000	0.138	6	A
	-4.00" -B1.25" -OF05-07	4.000	4.356	1.250	2.000	0.138	7	B
	-5.00" -B1.50" -OF05-08	5.000	5.356	1.500	2.500	0.138	8	B
	-6.00" -B1.50" -OF05-10	6.000	6.356	1.500	2.500	0.138	10	B
	-6.00" -C1.50" -OF05-10	6.000	6.356	1.500	2.500	0.138	10	C

Spare parts

Adaptable tool holders	Insert screw	Wrench	Sketch of installation
Ø2", Ø2.5"	I60M4×8.4	WT15IS	
Ø3", Ø4", Ø5", Ø6"	I60M4×10	WT15IS	

Recommended cutting parameters

Workpiece material	Hardness HB	Insert grade	Cutting parameters			
			V(SFPM)	f(in/z)		
				-DF	-DM	
P	Low-carbon steel, Soft steel	≤ 180	YBM251	900(700-1100)	0.008(0.004-0.012)	0.01(0.004-0.016)
			YBG202	900(650-1200)	0.008(0.004-0.012)	0.01(0.004-0.016)
			YBM351	700(600-1000)	0.008(0.004-0.012)	0.01(0.004-0.016)
			YBG302	750(550-1200)	0.008(0.004-0.012)	0.01(0.004-0.016)
	High-carbon steel, Alloy steel	180-280	YBM251	800(650-1100)	0.006(0.004-0.012)	0.008(0.004-0.016)
			YBG202	800(600-1100)	0.006(0.004-0.012)	0.008(0.004-0.016)
			YBM351	650(500-900)	0.008(0.004-0.012)	0.01(0.004-0.016)
			YBG302	700(500-1100)	0.008(0.004-0.012)	0.01(0.004-0.016)
	Alloy tool steel	280-350	YBM251	700(600-1000)	0.008(0.004-0.012)	0.008(0.004-0.016)
			YBG202	700(550-1100)	0.008(0.004-0.012)	0.008(0.004-0.016)
			YBM351	600(500-800)	0.008(0.004-0.012)	0.01(0.004-0.016)
			YBG302	600(400-1000)	0.008(0.004-0.012)	0.01(0.004-0.016)
M	Stainless steel	≤ 270	YBG202	450(300-800)	0.006(0.004-0.012)	0.008(0.004-0.016)
			YBM251	500(400-800)	0.006(0.004-0.012)	0.008(0.004-0.016)
K	Cast iron	180-250	YBG102	700(400-1000)	0.008(0.004-0.012)	0.01(0.004-0.016)
N				-LH		
	Aluminium alloy	-	YD101	1000-	0.006(0.002-0.012)	

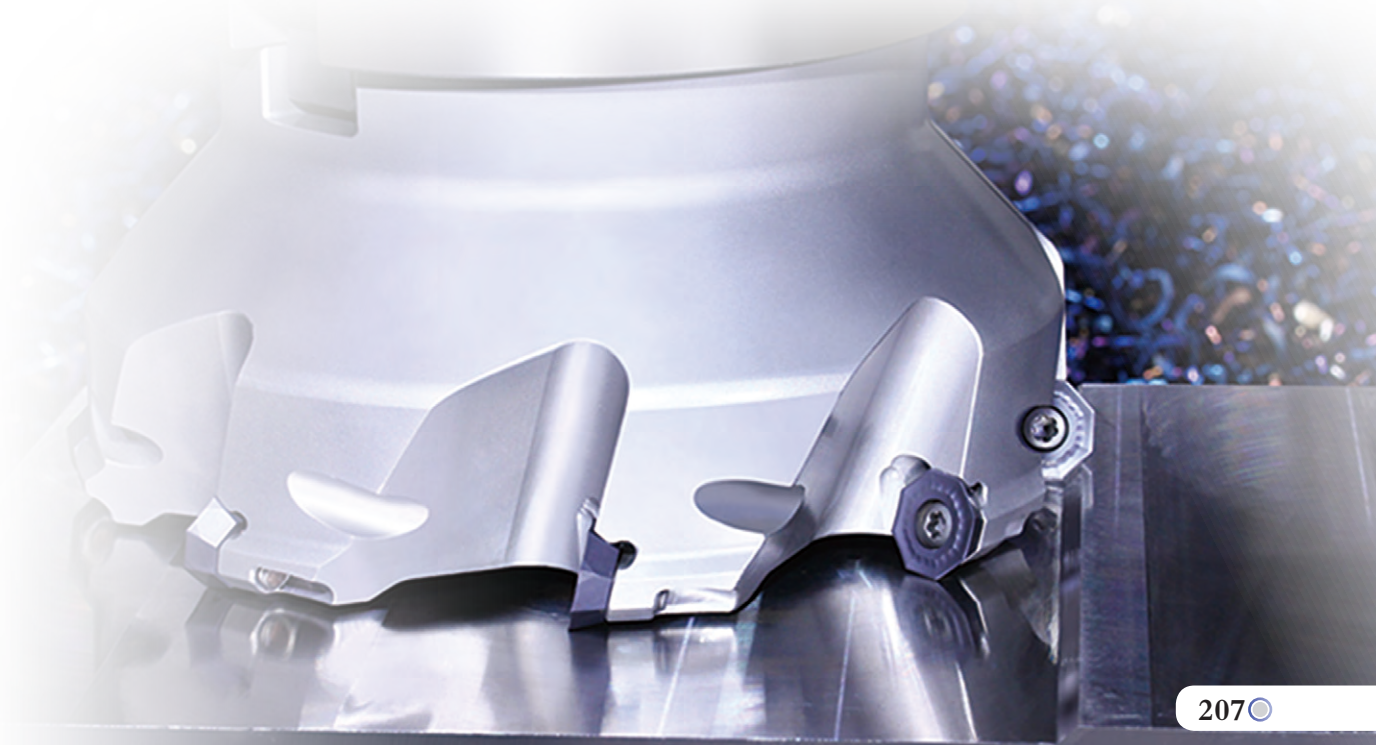

Face milling tools **Kr:45°**



FMA04 P M K





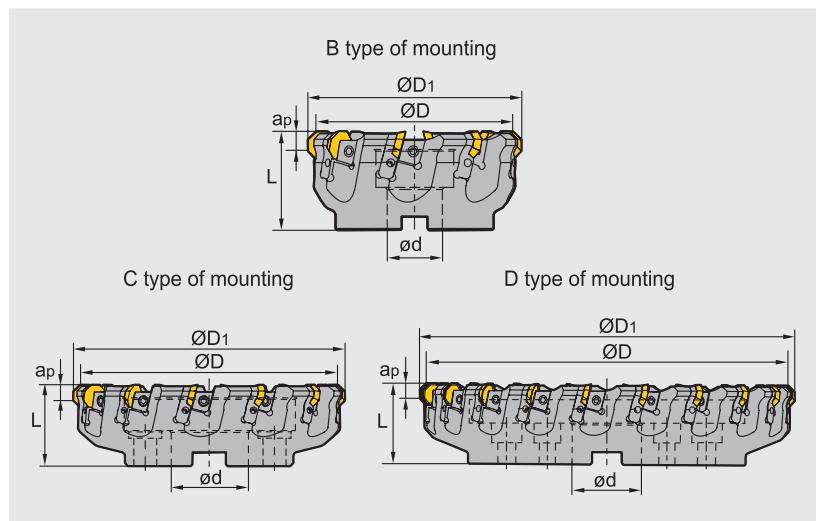

Top clamping



Specification of tools

Type		Dimensions(inch)						
		ØD	ØD ₁	Ød	L	a _{pmax}	Z	Interface form
FMA04	-5.00"-B1.50"-OF07-08	5.000	5.469	1.500	2.500	0.197	8	B
	-6.00"-B1.50"-OF07-10	6.000	6.469	1.500	2.500	0.197	10	B
	-8.00"-C2.50"-OF07-12	8.000	8.469	2.500	2.500	0.197	12	C
	-10.0"-C2.50"-OF07-16	10.00	10.469	2.500	2.500	0.197	16	C
	-12.5"-D2.50"-OF07-20	12.50	12.969	2.500	2.500	0.197	20	D

Spare parts

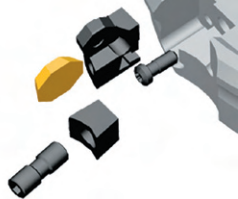
Locator	Wedge	Wedge screw	Locator screw	Wrench	Sketch of installation
 LOF07R/L	 W02R/L	 DM8×21X	 LOM5×15.1	 WH20T WH40T	
					

Recommended cutting parameters

Workpiece material	Hardness HB	Insert grade	Cutting parameters			
			V(SFPM)	f(in/z)		
				-DF	-DM	
P Low-carbon steel, Soft steel	≤ 180	YBM251 YBM253	900(700-1100)	0.008(0.004-0.012)	0.01(0.004-0.016)	
		YBG202	900(650-1200)	0.008(0.004-0.012)	0.01(0.004-0.016)	
		YBM351	700(600-1000)	0.008(0.004-0.012)	0.01(0.004-0.016)	
		YBG302	750(550-1100)	0.008(0.004-0.012)	0.01(0.004-0.016)	
	High-carbon steel, Alloy steel	180-280	YBM251 YBM253	800(650-1000)	0.006(0.004-0.012)	0.008(0.004-0.016)
			YBG202	800(600-1100)	0.006(0.004-0.012)	0.008(0.004-0.016)
			YBM351	650(500-900)	0.008(0.004-0.012)	0.01(0.004-0.016)
			YBG302	700(500-1100)	0.008(0.004-0.012)	0.01(0.004-0.016)
	Alloy tool steel	280-350	YBM251 YBM253	700(600-1000)	0.006(0.004-0.012)	0.008(0.004-0.016)
			YBG202	700(550-1100)	0.006(0.004-0.012)	0.008(0.004-0.016)
			YBM351	600(500-800)	0.008(0.004-0.012)	0.01(0.004-0.016)
			YBG302	600(400-1000)	0.008(0.004-0.012)	0.01(0.004-0.016)
M Stainless steel	≤ 270	YBG202	500(360-900)	0.006(0.004-0.012)	0.008(0.004-0.016)	
		YBG302	450(300-800)	0.006(0.004-0.012)	0.008(0.004-0.016)	
		YBM251 YBM253	500(400-800) 750(550-1000)	0.006(0.004-0.012)	0.008(0.004-0.016)	
K Cast iron	180-250	YBG102	700(400-1000) 600(500-800)	0.008(0.002-0.012)	0.01(0.004-0.016)	

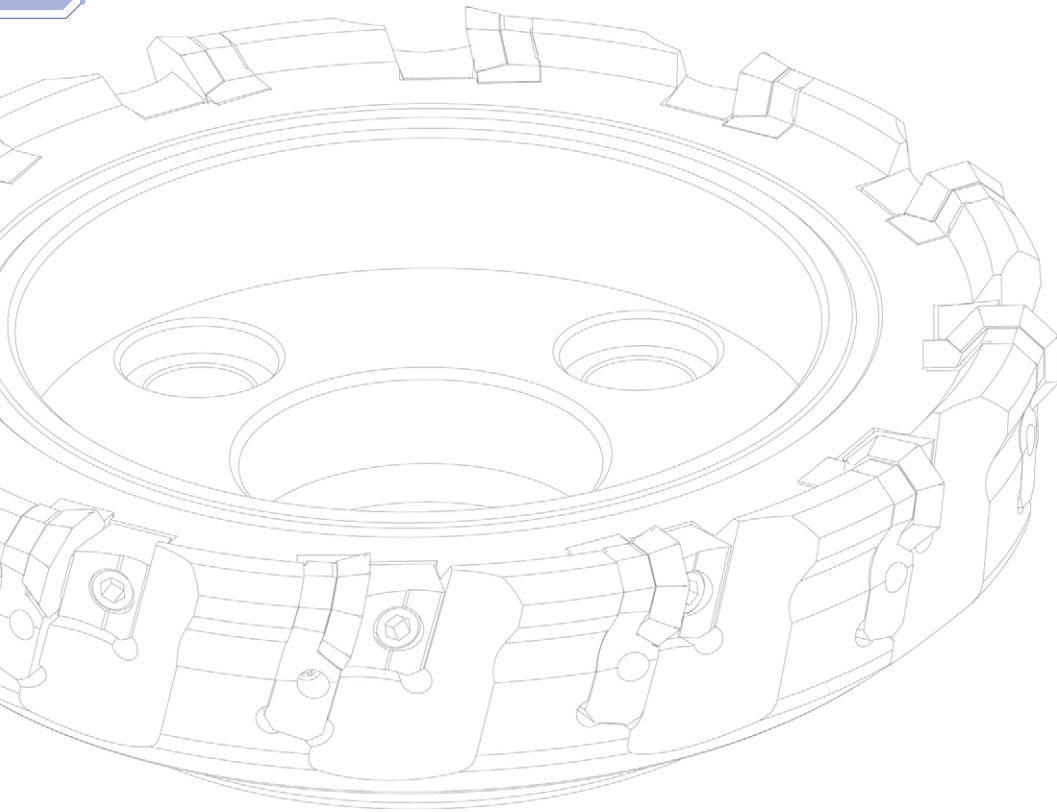

FMA11 Kr:45° Series Face Mills

With outstanding economy and high performance

Cutter body with PVD coating for superior corrosion and heat resistance resulting in longer service life.

4 × 2 = 8edge

Comprehensive upgrading of -GM geometry, good chip breaking performance, large rake angle, reduced cutting force.

New -HGR geometry, high edge strength, excellent breakage resistance.

Insert with wiper, smoother surface roughness.

Complete range of insert specifications and geometries, for different cutting depths and different machining demands.

Double negative structure, excellent impact resistance.

Optimized design of pitch and chip pocket, for unobstructed chip flow and higher cutting efficiency.

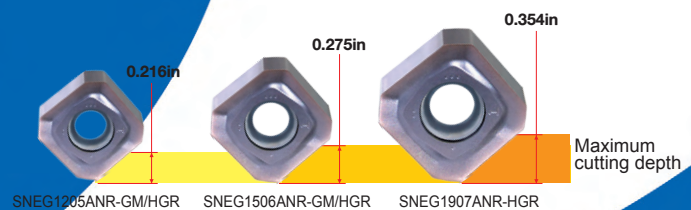

-W special geometry for wiper inserts, large arc design, improved workpiece quality.

Extra long wiper, moresuited to semi-finishing and finishing with large diameter cutters.

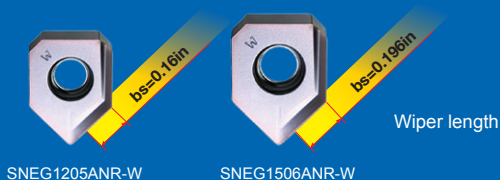

Face milling tools **Kr:45°**



FMA11 **P** **K**

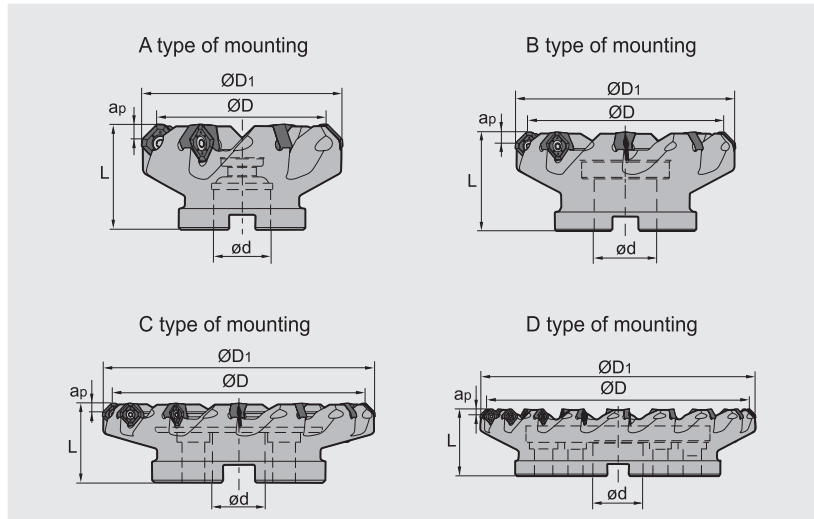

Specification of tools

Type	Basic dimensions (inch)					Z	Interface form	
	ØD	ØD ₁	Ød	L	a _p max			
FMA11 Coarse pitch	-2.00"-A0.75"-SN12-04C	2.000	2.453	0.750	1.750	0.216	4	A
	-2.50"-A0.75"-SN12-05C	2.500	2.953	0.750	1.750	0.216	5	A
	-3.00"-A1.00"-SN12-06C	3.000	3.453	1.000	2.000	0.216	6	A
	-4.00"-B1.50"-SN12-07	4.000	4.453	1.500	2.500	0.216	7	B
	-5.00"-B1.50"-SN12-08	5.000	5.453	1.500	2.500	0.216	8	B
	-6.00"-B2.00"-SN12-10	6.000	6.453	2.000	2.500	0.216	10	B
	-2.00"-A0.75"-SN15-04C	2.000	2.602	0.750	1.750	0.275	4	A
	-2.50"-A0.75"-SN15-05C	2.500	3.102	0.750	1.750	0.275	5	A
	-3.00"-A1.00"-SN15-06C	3.000	3.602	1.000	2.000	0.275	6	A
	-4.00"-B1.50"-SN15-07	4.000	4.602	1.500	2.500	0.275	7	B
	-5.00"-B1.50"-SN15-08	5.000	5.602	1.500	2.500	0.275	8	B
	-6.00"-B2.00"-SN15-10	6.000	6.602	2.000	2.500	0.275	10	B
	-8.00"-C2.50"-SN15-12	8.000	8.602	2.500	2.500	0.275	12	C
	-10.00"-C2.50"-SN15-14	10.000	10.602	2.500	2.500	0.275	14	C
	-12.00"-D2.50"-SN15-18	12.000	12.602	2.500	2.500	0.275	18	D
	-5.00"-B1.50"-SN19-07	5.000	5.720	1.500	2.500	0.354	7	B
-6.00"-B2.00"-SN19-09	6.000	6.720	2.000	2.500	0.354	9	B	
-8.00"-C2.50"-SN19-11	8.000	8.720	2.500	2.500	0.354	11	C	
-10.00"-C2.50"-SN19-13	10.000	10.720	2.500	2.500	0.354	13	C	
-12.00"-D2.50"-SN19-16	12.000	12.720	2.500	2.500	0.354	16	D	

D

Face milling tools **Kr:45°**



FMA11 **P** **K**

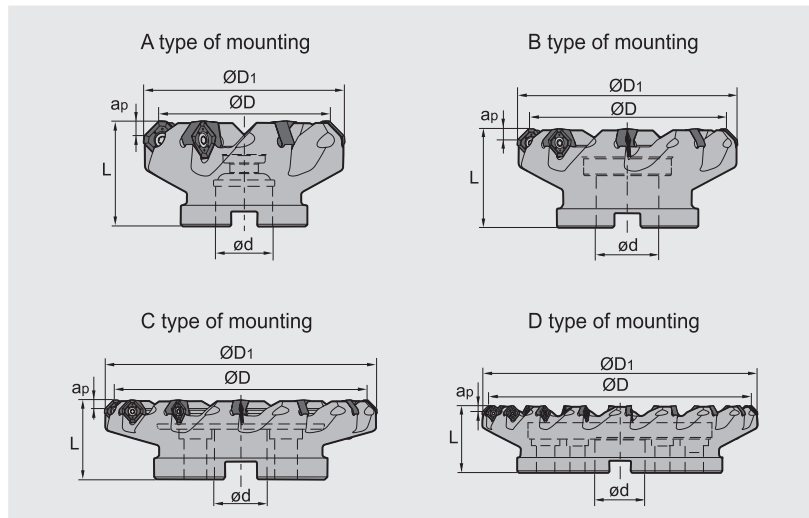
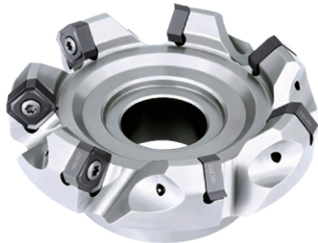

Specification of tools

Type	Basic dimensions (inch)					Z	Interface form	
	ØD	ØD1	Ød	L	apmax			
FMA11 Close pitch	-2.50"-A0.75"-SN12-06C	2.500	2.953	0.750	1.750	0.216	6	A
	-3.00"-A1.00"-SN12-07C	3.000	3.453	1.000	2.000	0.216	7	A
	-4.00"-B1.50"-SN12-09	4.000	4.453	1.500	2.500	0.216	9	B
	-5.00"-B1.50"-SN12-10	5.000	5.453	1.500	2.500	0.216	10	B
	-6.00"-B2.00"-SN12-12	6.000	6.453	2.000	2.500	0.216	12	B
	-2.50"-A0.75"-SN15-06C	2.500	3.102	0.750	1.750	0.275	6	A
	-3.00"-A1.00"-SN15-07C	3.000	3.602	1.000	2.000	0.275	7	A
	-4.00"-B1.50"-SN15-09	4.000	4.602	1.500	2.500	0.275	9	B
	-5.00"-B1.50"-SN15-10	5.000	5.602	1.500	2.500	0.275	10	B
	-6.00"-B2.00"-SN15-12	6.000	6.602	2.000	2.500	0.275	12	B
	-8.00"-C2.50"-SN15-15	8.000	8.602	2.500	2.500	0.275	15	C
	-10.00"-C2.50"-SN15-18	10.000	10.602	2.500	2.500	0.275	18	C
	-12.00"-D2.50"-SN15-22	12.000	12.602	2.500	2.500	0.275	22	D
	-5.00"-B1.50"-SN19-09	5.000	5.720	1.500	2.500	0.354	9	B
	-6.00"-B2.00"-SN19-11	6.000	6.720	2.000	2.500	0.354	11	B
	-8.00"-C2.50"-SN19-14	8.000	8.720	2.500	2.500	0.354	14	C
-10.00"-C2.50"-SN19-17	10.000	10.720	2.500	2.500	0.354	17	C	
-12.00"-D2.50"-SN19-20	12.000	12.720	2.500	2.500	0.354	20	D	

Spare parts

Diameter ØD	Insert specification	Insert screw	Wrench	
Ø2.00" -Ø6.00"	SNEG1205ANR-GM/HGR/W	I60M3.5×10	--	WT15IS
Ø2.00" -Ø12.00"	SNEG1506ANR-GM/HGR/W	I60M5×13	WT20IT	--
Ø5.00" -Ø12.00"	SNEG1907ANR-HGR	I43M6×16	WT25IT	--

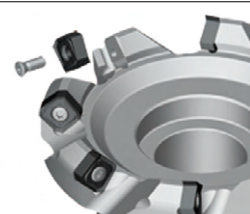

Recommended cutting parameters

	Workpiece material	Hardness HB	Grade	Cutting data		
				V(SFPM)	f(inch/z)	a _{pmax} (inch)
P	Low carbon steel Soft steel	≤ 180	YBM253 YBC302 YBG205 YB9320	880 (720-1200)	0.008 (0.004-0.016)	0.216(SN12) 0.275(SN15) 0.354(SN19)
	High carbon steel Alloy steel	180-280	YBM253 YBC302 YBG205 YB9320	850 (650-1050)	0.008 (0.004-0.016)	
	Alloy tool steel	280-350	YBM253 YBC302 YBG205 YB9320	780 (590-1000)	0.008 (0.004-0.016)	
K	Cast iron	180-250	YBD152	880 (490-980)	0.012(0.004-0.02)	
			YBD252	650 (490-820)	0.016 (0.008-0.024)	

Case for FMA11

(Comparison of tool life)

Workpiece material: NAK80

Operation: Face milling

Tool: FMA11-5.00"-B1.50"-SN12-08

Insert: SNEG1205ANR-HGR/YBG205

Cutting data: V_c=650 SFPM, f_z=0.08in/z,

A_p=0.08in, A_e=2.0in

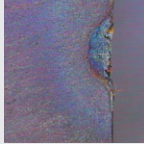
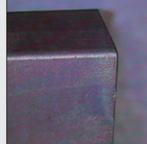
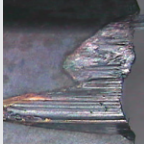
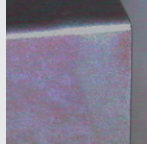

	Products of company A	-HGR/YBG205
Test Group 1		
Life	22 minutes Breakage	35 minutes, wear 0.0008in
Test Group 2		
Life	27 minutes Breakage	35 minutes, wear 0.0004 in

D

FMA 12 Series Kr:45°

High Performance Face Mill with 16 edges for outstanding economy



Unique 3-dimensional edge

Double negative rake angle, in combination with helical insert structure, achieves double positive axial angle, which will help reduce cutting resistance and improve chip evacuation.



8 × 2 = 16 edges

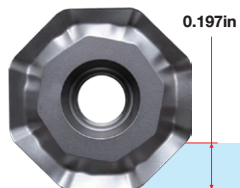

ONHU08T624R-GM

Maximum cutting depth

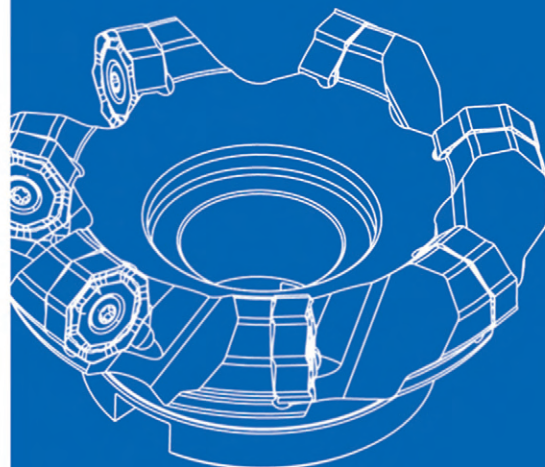

Face milling tools **Kr:45°**



FMA12 **P** **M** **K**

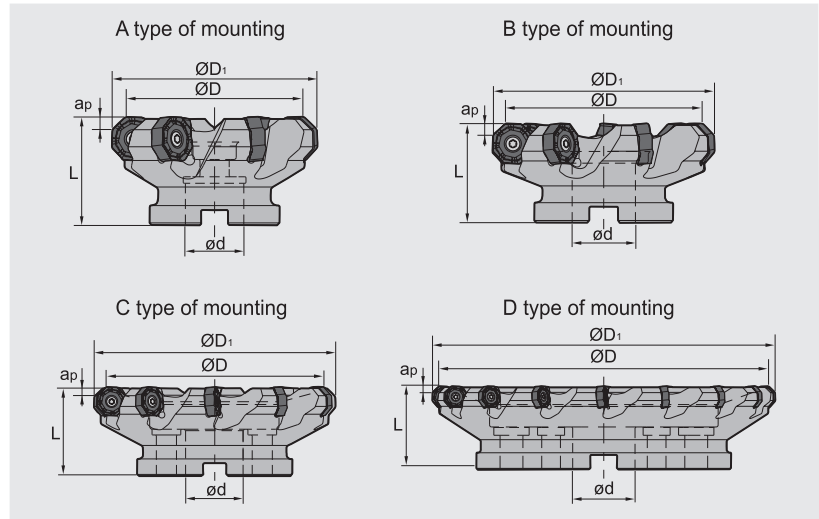

Specification of tools

Type	Basic dimensions (inch)					Z	Interface form	
	ØD	ØD ₁	Ød	L	a _{pmax}			
FMA12	-2.50"-A0.75"-ON08-05	2.500	3.091	0.750	1.750	0.197	5	A
	-3.00"-A1.00"-ON08-06	3.000	3.591	1.000	2.000	0.197	6	A
	-4.00"-B1.25"-ON08-07	4.000	4.591	1.250	2.500	0.197	7	B
	-5.00"-B1.50"-ON08-08	5.000	5.591	1.500	2.500	0.197	8	B
	-6.00"-B2.00"-ON08-10	6.000	6.591	2.000	2.500	0.197	10	B
	-8.00"-C2.50"-ON08-12	8.000	8.591	2.500	2.500	0.197	12	C
	-10.00"-C2.50"-ON08-14	10.000	10.591	2.500	2.500	0.197	14	C
	-12.00"-D2.50"-ON08-16	12.000	12.591	2.500	2.500	0.197	16	D



Spare parts

Diameter ØD	Insert specification	Insert screw	Wrench	
Ø2.50"-Ø12.00"	ONHU08T624R-GM	I60M5X13	WT20IT	



High strength
screw clamping



67° approach angle



Wiper



Each insert has 10
cutting edges

Whirl wind **FMD02** milling cutter series

- ▶ New generation of milling cutter for face milling mainly in automotive industry.
- ▶ Open chipbreaker and large rake angle design, suitable for machines of different power.
- ▶ Wiper insert guarantees stable good surface quality at different feed rates.
- ▶ The high precision insert pocket design, ensures high accuracy insert positioning and strong clamping of inserts for a stable machining process.
- ▶ The Pentagon insert with 10 cutting edges and offers outstanding machining economy.

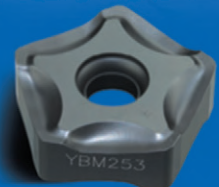

Face milling tools

Kr:67°



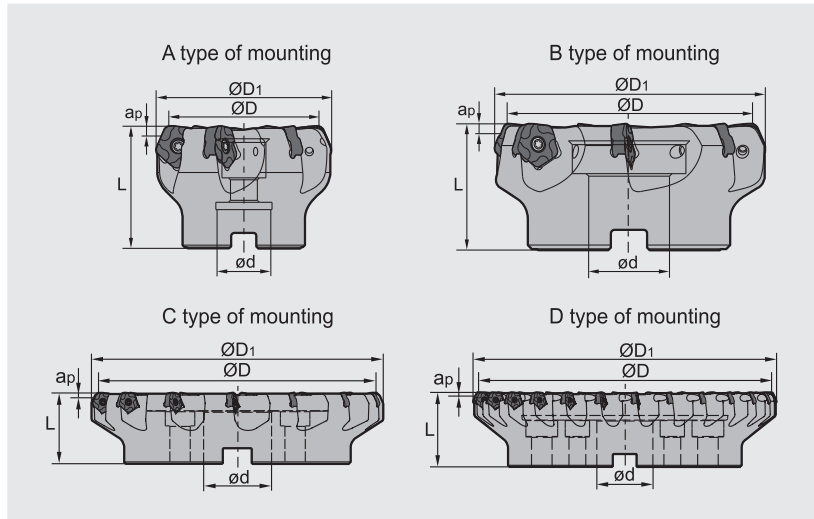

FMD02 P K



Specification of tools

Type		Dimensions(inch)						
		ØD	ØD ₁	Ød	L	a _{pmax}	Z	Interface form
FMD02 Coarse pitch (unequal pitch)	-2.00"-A0.75"-PN11-04	2.00	2.398	0.750	1.750	0.197/0.276	4	A
	-2.50"-A0.75"-PN11-05	2.50	2.898	0.750	1.750	0.197/0.276	5	A
	-3.00"-A1.00"-PN11-06	3.00	3.398	1.000	2.000	0.197/0.276	6	A
	-4.00"-B1.25"-PN11-07	4.00	4.398	1.250	2.000	0.197/0.276	7	B
	-5.00"-B1.50"-PN11-08	5.00	5.398	1.500	2.500	0.197/0.276	8	B
	-6.00"-B1.50"-PN11-10	6.00	6.398	1.500	2.500	0.197/0.276	10	B
	-8.00"-C2.50"-PN11-12	8.00	8.398	2.500	2.500	0.197/0.276	12	C
	-10.00"-C2.50"-PN11-14	10.00	10.398	2.500	2.500	0.197/0.276	14	C
Close pitch	-2.00"-A0.75"-PN11-05	2.00	2.398	0.750	1.750	0.197/0.276	5	A
	-2.50"-A0.75"-PN11-06	2.50	2.898	0.750	1.750	0.197/0.276	6	A
	-3.00"-A1.00"-PN11-08	3.00	3.398	1.000	2.000	0.197/0.276	8	A
	-4.00"-B1.25"-PN11-10	4.00	4.398	1.250	2.000	0.197/0.276	10	B
	-5.00"-B1.50"-PN11-12	5.00	5.398	1.500	2.500	0.197/0.276	12	B
	-6.00"-B1.50"-PN11-14	6.00	6.398	1.500	2.500	0.197/0.276	14	B
	-8.00"-C2.50"-PN11-16	8.00	8.398	2.500	2.500	0.197/0.276	16	C
	-10.00"-C2.50"-PN11-18	10.00	10.398	2.500	2.500	0.197/0.276	18	C
-12.00"-D2.50"-PN11-26	12.00	12.398	2.500	2.500	0.197/0.276	26	D	

Spare parts

Diameter ØD	Insert screw	Wrench	Sketch of installation
Ø2.00"-Ø12.00"	 I60M4x10	 WT15IS	

Face milling tools **Kr:67°**





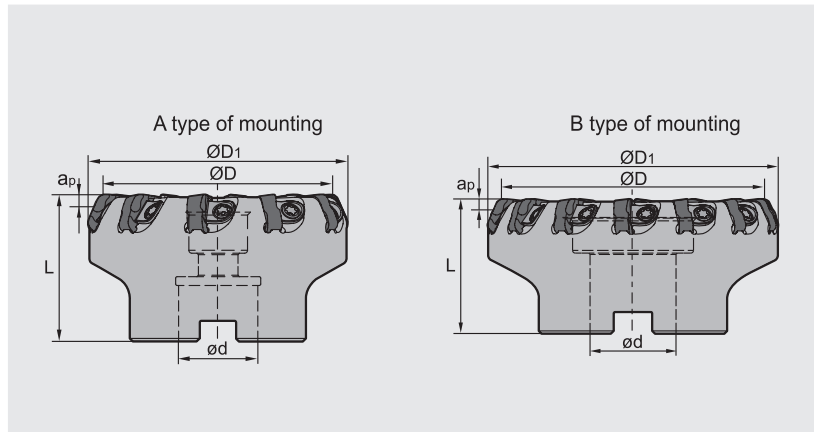

FMD02 **P K**



Specification of tools

Type		Dimension(inch)						
		$\varnothing D$	$\varnothing D_1$	$\varnothing d$	L	a_{pmax}	Z	Interface form
FMD02 Extra close pitch	-3.00"-A1.00"-PN11-10	3.00	3.398	1.000	1.750	0.197	10	A
	-4.00"-B1.25"-PN11-14	4.00	4.398	1.250	2.000	0.197	14	B
	-5.00"-B1.50"-PN11-18	5.00	5.398	1.500	2.500	0.197	18	B
	-6.00"-B1.50"-PN11-22	6.00	6.398	1.500	2.500	0.197	22	B

Spare parts

Diameter $\varnothing D$	Wedge	Insert screw	Wrench	Sketch of installation
$\varnothing 3.00''$ - $\varnothing 6.00''$	 W18N	 DM6x20A	 WT15IT	

Selection of inserts

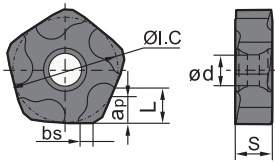

😊 Good working conditions 😐 General working conditions 😞 Adverse working conditions

Workpiece material	P Steel	M Stainless steel	K Cast iron	N Ferrite materials	S Heat-resistant steel
P Steel	😊😊😊😊	😊😊😊😊	😊😊😊😊	😊😊😊😊	😊😊😊😊
M Stainless steel	😊😊😊😊	😊😊😊😊	😊😊😊😊	😊😊😊😊	😊😊😊😊
K Cast iron	😊😊😊😊	😊😊😊😊	😊😊😊😊	😊😊😊😊	😊😊😊😊
N Ferrite materials	😊😊😊😊	😊😊😊😊	😊😊😊😊	😊😊😊😊	😊😊😊😊
S Heat-resistant steel	😊😊😊😊	😊😊😊😊	😊😊😊😊	😊😊😊😊	😊😊😊😊

Insert shape	Type	Dimensions(inch)						Coated grade										Cermet		Cemented carbide							
		L	ØI.C	S	Ød	bs	apmax	YBC302	YBM251	YBM253	YBM351	YBD152	YBD252	YBG102	YBG202	YBG205	YB9320	YBG302	YBG152	YBG252	YNG151	YNG151C	YC30S	YD051	YD101	YD201	
	PNEG110512R-CF	0.213	0.625	0.219	0.183	0.063	0.197					●															
	PNEG110512L-CF	0.213	0.625	0.219	0.183	0.063	0.197					●															
	PNEG110512R-CM	0.213	0.625	0.219	0.183	0.063	0.197					●															
	PNEG110512L-CM	0.213	0.625	0.219	0.183	0.063	0.197					●															
	PNEG110512R-CR	0.213	0.625	0.219	0.183	0.063	0.197					●															
	PNEG110512L-CR	0.213	0.625	0.219	0.183	0.063	0.197					●															

● Always stock available ○ Produce according to order

Selection of inserts

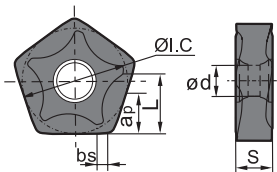

😊 Good working conditions 😐 General working conditions 😞 Adverse working conditions

Workpiece material	P Steel	M Stainless steel	K Cast iron	N Ferrite materials	S Heat-resistant steel
P Steel	😊😊😊😊	😊😊😊😊	😊😊😊😊	😊😊😊😊	😊😊😊😊
M Stainless steel	😊😊😊😊	😊😊😊😊	😊😊😊😊	😊😊😊😊	😊😊😊😊
K Cast iron	😊😊😊😊	😊😊😊😊	😊😊😊😊	😊😊😊😊	😊😊😊😊
N Ferrite materials	😊😊😊😊	😊😊😊😊	😊😊😊😊	😊😊😊😊	😊😊😊😊
S Heat-resistant steel	😊😊😊😊	😊😊😊😊	😊😊😊😊	😊😊😊😊	😊😊😊😊

Insert shape	Type	Dimensions(inch)						Coated grade										Cermet		Cemented carbide							
		L	ØI.C	S	Ød	bs	apmax	YBC302	YBM251	YBM253	YBM351	YBD152	YBD252	YBG102	YBG202	YBG205	YB9320	YBG302	YBG152	YBG252	YNG151	YNG151C	YC30S	YD051	YD101	YD201	
	PNEG110512R-PF	0.296	0.625	0.219	0.183	0.056	0.276	●		●																	
	PNEG110512L-PF	0.296	0.625	0.219	0.183	0.056	0.276	●		●																	
	PNEG110512R-PM	0.296	0.625	0.219	0.183	0.056	0.276	●		●																	
	PNEG110512L-PM	0.296	0.625	0.219	0.183	0.056	0.276	●		●																	
	PNEG110512R-PR	0.296	0.625	0.219	0.183	0.056	0.276	●		●																	
	PNEG110512L-PR	0.296	0.625	0.219	0.183	0.056	0.276	●		●																	

● Always stock available ○ Produce according to order

Recommended cutting parameters

Workpiece material	Hardness HB	Insert grade	Cutting parameters			
			V(SFPM)	f(in/z)		
				PF	PM	PR
P Low carbon steel, Soft steel	≤ 180	YBC302 YBM253	900(700-1100)	0.006(0.004-0.008)	0.008(0.004-0.012)	0.012(0.008-0.016)
	180-280		850(650-1000)	0.006(0.004-0.008)	0.008(0.004-0.012)	0.012(0.008-0.016)
	280-350		800(600-950)	0.006(0.004-0.008)	0.008(0.004-0.012)	0.012(0.008-0.016)
K Cast iron	180-250	YBD152	900(500-1000)	CF	CM	CR
				0.006(0.004-0.008)	0.008(0.004-0.012)	0.012(0.008-0.016)

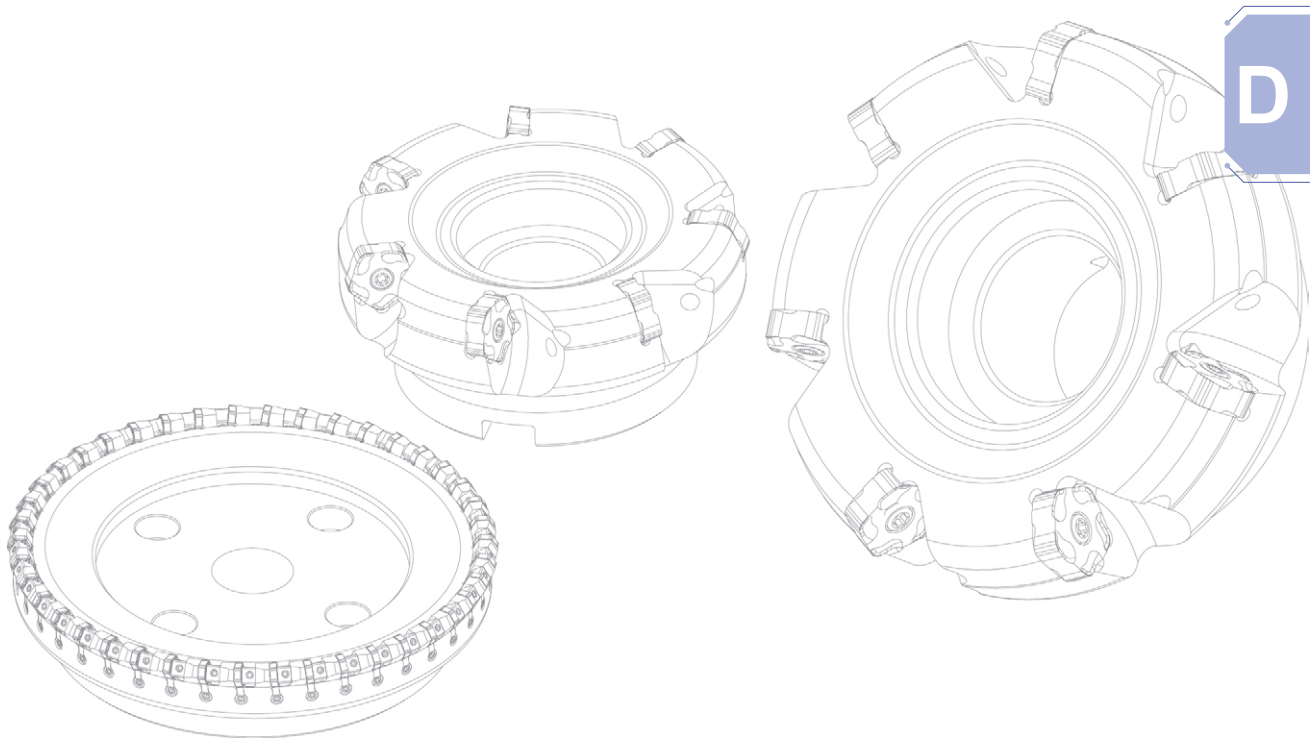

Face milling tools **Kr:60°**



FMD03 **P** **M** **K**

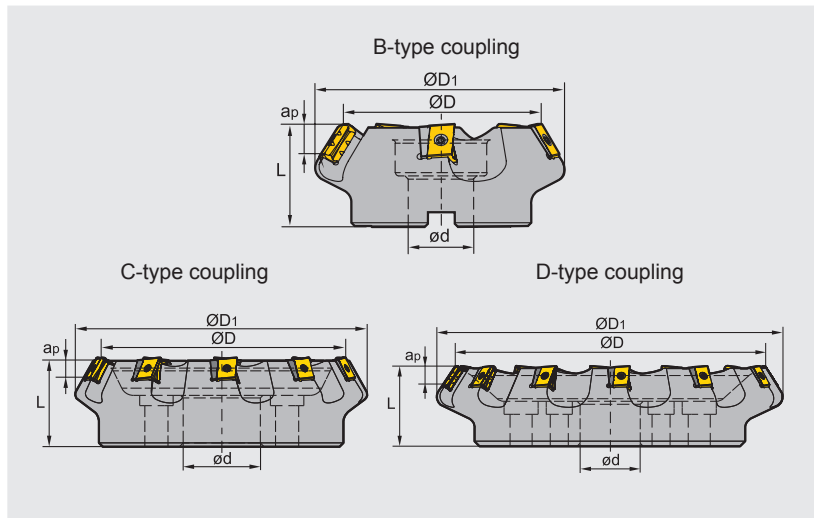

Specification of tools

Type		Dimensions(inch)						Interface form
		ØD	ØD1	Ød	L	apmax	Z	
FMD03	-5.00"-B1.5"-LN20-06	5.000	6.053	1.500	2.500	0.472	6	B
	-6.00"-C1.5"-LN20-08	6.000	7.053	1.500	2.500	0.472	8	C
	-8.00"-C2.5"-LN20-10	8.000	9.053	2.500	2.500	0.472	10	C
	-10.00"-C2.5"-LN20-12	10.000	11.053	2.500	2.500	0.472	12	C
	-12.00"-D2.5"-LN20-15	12.000	13.053	2.500	2.500	0.472	15	D
	-5.00"-B1.5"-LN25-05	5.000	6.172	1.500	2.500	0.669	5	B
	-6.00"-C1.5"-LN25-06	6.000	7.172	1.500	2.500	0.669	6	C
	-8.00"-C2.5"-LN25-08	8.000	9.172	2.500	2.500	0.669	8	C
	-10.00"-C2.5"-LN25-10	10.000	11.172	2.500	2.500	0.669	10	C
	-12.00"-D2.5"-LN25-12	12.000	13.172	2.500	2.500	0.669	12	D

Spare parts

Inserts	Shim	Shim screw	Insert screw	Wrench		Sketch of installation
	LNKT2007DN-ZR	LLN20R-ZR	I60M3×7	I60M4×15	WT15IS	
LNKT2510-ZR	LLN25R-ZR	I60M3.5×10.4	I60M5×17	WT20IT	WT15IS	

Face milling tools

Kr:67°



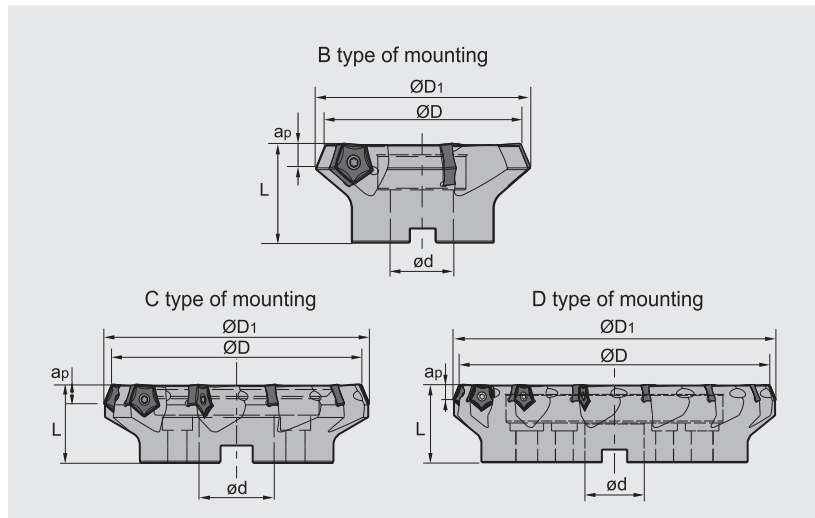

FMD04 **P** **K**



Specification of tools

Type		Dimensions(inch)						
		ØD	ØD1	Ød	L	apmax	Z	Interface form
FMD04	-5.00"-B1.50"-PN17-06	5.000	5.496	1.500	2.500	0.472	6	B
	-6.00"-B2.00"-PN17-08	6.000	6.496	2.000	2.500	0.472	8	B
	-8.00"-C2.50"-PN17-10	8.000	8.496	2.500	2.500	0.472	10	C
	-10.00"-C2.50"-PN17-12	10.000	10.496	2.500	2.500	0.472	12	C
	-12.00"-D2.50"-PN17-14	12.000	12.496	2.500	2.500	0.472	14	D

Spare parts

Diameter ØD	Insert screw	Wrench	Sketch of installation
Ø5.00" -Ø12.00"	 I43M6×16	 WT25IT	

Selection of inserts

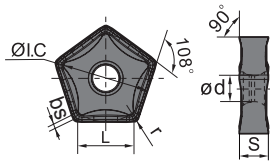

😊 Good working conditions 😐 General working conditions 😞 Adverse working conditions

Workpiece material	P Steel	M Stainless steel	K Cast iron	N Ferrite materials	S Heat-resistant steel	YBC302	YBM251	YBM253	YBM351	YBD152	YBD252	YBG102	YBG202	YBG205	YB9320	YBG302	YBG152	YBG252	YNG151	YNG151C	YC30S	YD051	YD101	YD201
P Steel	😊	😊	😊	😊	😊	😊	😊	😊	😊	😊	😊	😊	😊	😊	😊	😊	😊	😊	😊	😊	😊	😊	😊	😊
M Stainless steel	😊	😊	😊	😊	😊	😊	😊	😊	😊	😊	😊	😊	😊	😊	😊	😊	😊	😊	😊	😊	😊	😊	😊	😊
K Cast iron	😊	😊	😊	😊	😊	😊	😊	😊	😊	😊	😊	😊	😊	😊	😊	😊	😊	😊	😊	😊	😊	😊	😊	😊
N Ferrite materials	😊	😊	😊	😊	😊	😊	😊	😊	😊	😊	😊	😊	😊	😊	😊	😊	😊	😊	😊	😊	😊	😊	😊	😊
S Heat-resistant steel	😊	😊	😊	😊	😊	😊	😊	😊	😊	😊	😊	😊	😊	😊	😊	😊	😊	😊	😊	😊	😊	😊	😊	😊

Insert shape	Type	Dimensions(inch)						Coated grade										Cermet	Cemented carbide							
		L	ØI.C	S	Ød	bs	r	YBC302	YBM251	YBM253	YBM351	YBD152	YBD252	YBG102	YBG202	YBG205	YB9320	YBG302	YBG152	YBG252	YNG151	YNG151C	YC30S	YD051	YD101	YD201
	PNGU170712R-GR	0.554	0.925	0.312	0.283	0.049	0.047	●		●		●														

● Always stock available ○ Produce according to order

Recommended cutting parameters

Workpiece material	Hardness HB	Insert grade	Cutting parameters	
			V(SFPM)	f(in/z)
P Low carbon steel, Soft steel	≤ 180	YBC302 YBM253	400(300-450)	0.012(0.008-0.016)
	180-280		350(300-400)	0.008(0.004-0.012)
	280-350		300(200-400)	0.008(0.004-0.012)
K Cast iron	180-250	YBD152	500(300-600)	0.012(0.008-0.016)

D

Face milling tools **Kr:75°**



FME04 **P M K**

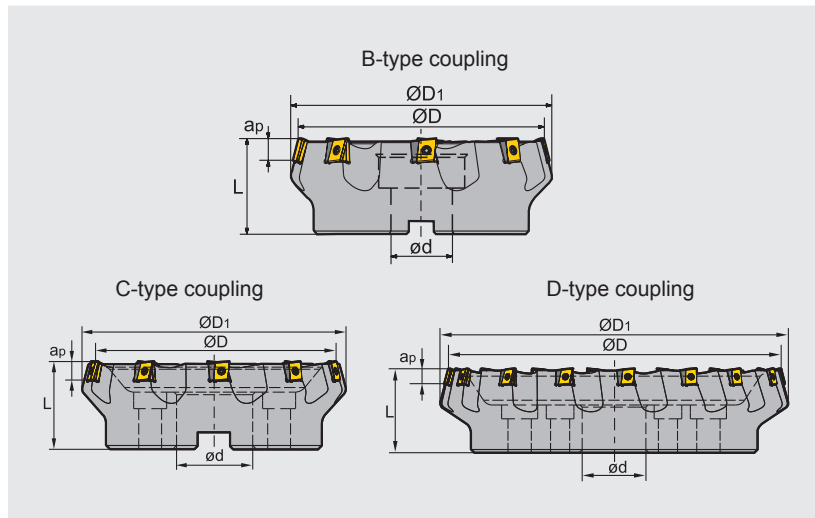

Specification of tools

Type		Dimensions(inch)						Interface form
		ØD	ØD ₁	Ød	L	a _{pmax}	Z	
FME04	-5.00"-B1.5"-LN15-06	5.000	5.388	1.500	2.500	0.472	6	B
	-6.00"-B1.5"-LN15-08	6.000	6.388	1.500	2.500	0.472	8	B
	-8.00"-C2.5"-LN15-10	8.000	8.388	2.500	2.750	0.472	10	C
	-10.00"-C2.5"-LN15-12	10.000	10.388	2.500	2.750	0.472	12	C
	-12.00"-D2.5"-LN15-16	12.000	12.388	2.500	3.150	0.472	16	D

Spare parts

Diameter ØD	Shim	Shim screw	Insert screw	Wrench	Sketch of installation
Ø5.00"-Ø12.00"	LLN15-ZR	I60M3×7	I60M4×12	WT15IS, WT09IS	

Face milling tools **Kr:90°**



FMP01 **P** **M** **K**

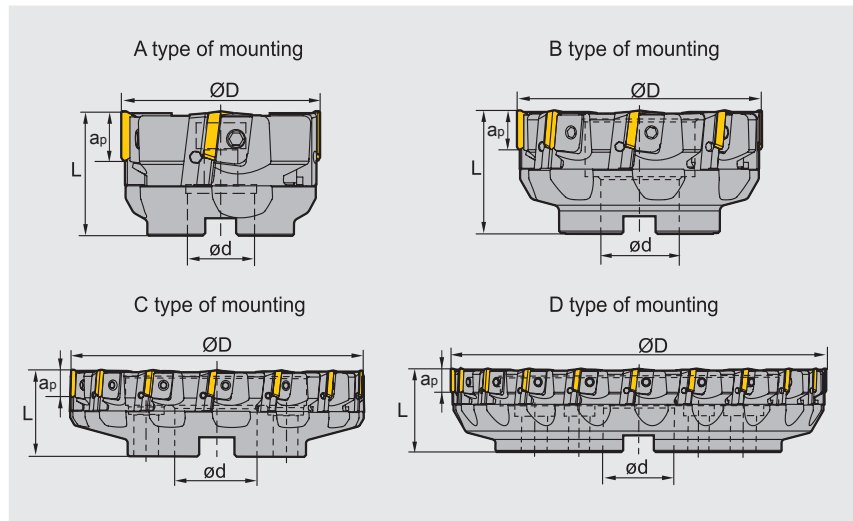

Specification of tools

Type		Dimensions(inch)				
		ØD	Ød	L	apmax	Z
FMP01	-3.00"-A1.00"-TP22-04	3.000	1.000	2.500	0.709	4
	-4.00"-B1.25"-TP22-06	4.000	1.250	2.500	0.709	6
	-5.00"-B1.50"-TP22-08	5.000	1.500	2.500	0.709	8
	-6.00"-B1.50"-TP22-10	6.000	1.500	2.500	0.709	10
	-8.00"-C2.50"-TP22-12	8.000	2.500	2.500	0.709	12
	-10.00"-C2.50"-TP22-16	10.00	2.500	2.500	0.709	16
	-12.00"-D2.50"-TP22-20	12.00	2.500	2.750	0.709	20

Spare parts

Diameter ØD	Locator	Wedge	Wedge screw	Locator Screw	Wrench	Sketch of installation
ØD3.00"~ØD4.00"	LTP4R1/L1	W04R/L	WM8×17	LOM5×15.1	WT20T	
ØD5.00"~ØD12.00"	LTP4R/L	W04R/L	WM8×22	LOM5×15.1	WT25T	

Face milling tools



FMP02 P M K

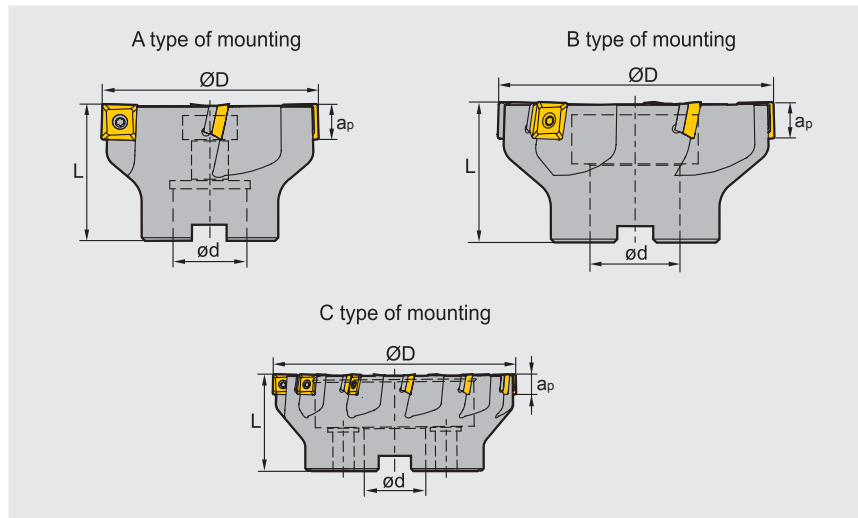

Specification of tools

Type		Dimensions (inch)					Interface form
		ØD	Ød	L	apmax	Z	
FMP02	-2.00"-A0.75"-SE09-05	2.000	0.750	1.500	0.285	5	A
	-2.50"-A1.00"-SE09-06	2.500	1.000	1.500	0.285	6	A
	-3.00"-A1.00"-SE09-08	3.000	1.000	2.000	0.285	8	A
	-4.00"-B1.25"-SE09-10	4.000	1.250	2.000	0.285	10	B
	-5.00"-B1.50"-SE09-12	5.000	1.500	2.500	0.285	12	B
	-6.00"-C1.50"-SE09-14	6.000	1.500	2.500	0.285	14	C
	-2.00"-A0.75"-SE12-03	2.000	0.750	1.500	0.425	3	A
	-2.00"-A1.00"-SE12-04	2.000	1.000	1.500	0.425	4	A
	-2.50"-A1.00"-SE12-04	2.500	1.000	1.500	0.425	4	A
	-2.50"-A1.00"-SE12-05	2.500	1.000	1.500	0.425	5	A
	-2.50"-A1.00"-SE12-06	2.500	1.000	1.500	0.425	6	A
	-3.00"-A1.00"-SE12-08	3.000	1.000	2.000	0.425	8	B
	-4.00"-B1.25"-SE12-10	4.000	1.250	2.000	0.425	10	B
	-5.00"-B1.50"-SE12-08	5.000	1.500	2.500	0.425	8	B
	-5.00"-B1.50"-SE12-12	5.000	1.500	2.500	0.425	12	C
	-6.00"-C1.50"-SE12-12	6.000	1.500	2.500	0.425	12	C
	-6.00"-C1.50"-SE12-15	6.000	1.500	2.500	0.425	15	C
	-8.00"-C2.50"-SE12-10	8.000	2.500	2.500	0.425	10	C
	-8.00"-C2.50"-SE12-16	8.000	2.500	2.500	0.425	16	C
	-10.00"-C2.50"-SE12-12	10.00	2.500	2.500	0.425	12	C
-10.00"-C2.50"-SE12-18	10.00	2.500	2.500	0.425	18	C	

Recommended cutting parameters

Workpiece material	Hardness HB	Insert grade	Cutting data				
			V(SFPM)	f(in/z)			
				-APF	-APM	-APR	
P Low carbon steel soft steel	≤ 180	YBG202	900(650-1200)	0.006(0.004-0.008)	0.008 (0.004-0.012)	0.012 (0.008-0.016)	
		YB9320	900(650-1200)	0.006(0.004-0.008)	0.008 (0.004-0.012)	0.012 (0.008-0.016)	
	High carbon steel alloy steel	180—280	YBM351	750 (660-1000)	0.006(0.004-0.008)	0.008 (0.004-0.012)	0.012 (0.008-0.016)
			YBG202	800 (600-1150)	0.006(0.004-0.008)	0.008 (0.004-0.012)	0.012 (0.008-0.016)
			YB9320	800 (600-1150)	0.006(0.004-0.008)	0.008 (0.004-0.012)	0.012 (0.008-0.016)
	Alloy tool steel	280—350	YBM351	700 (600-1000)	0.004(0.004-0.008)	0.008 (0.004-0.012)	0.012 (0.008-0.016)
YBG202			700 (550-1100)	0.004(0.004-0.008)	0.008 (0.004-0.012)	0.012 (0.008-0.016)	
YB9320			700 (550-1100)	0.004(0.004-0.008)	0.008 (0.004-0.012)	0.012 (0.008-0.016)	
M Stainless steel	≤ 270	YBM351	500 (400-800)	0.004(0.004-0.008)	0.008 (0.004-0.012)	0.012 (0.008-0.016)	
		YBG202	500 (350-900)	0.004(0.004-0.008)	0.008 (0.004-0.012)	0.012 (0.008-0.016)	
		YB9320	500 (350-900)	0.004(0.004-0.008)	0.008 (0.004-0.012)	0.012 (0.008-0.016)	
K Cast iron	180—250	YBG202	500 (400-650)	0.006(0.004-0.008)	0.008 (0.004-0.012)	0.012 (0.008-0.016)	
		YBD152	900 (500-1000)	0.006(0.004-0.008)	0.008 (0.004-0.012)	0.012 (0.008-0.016)	

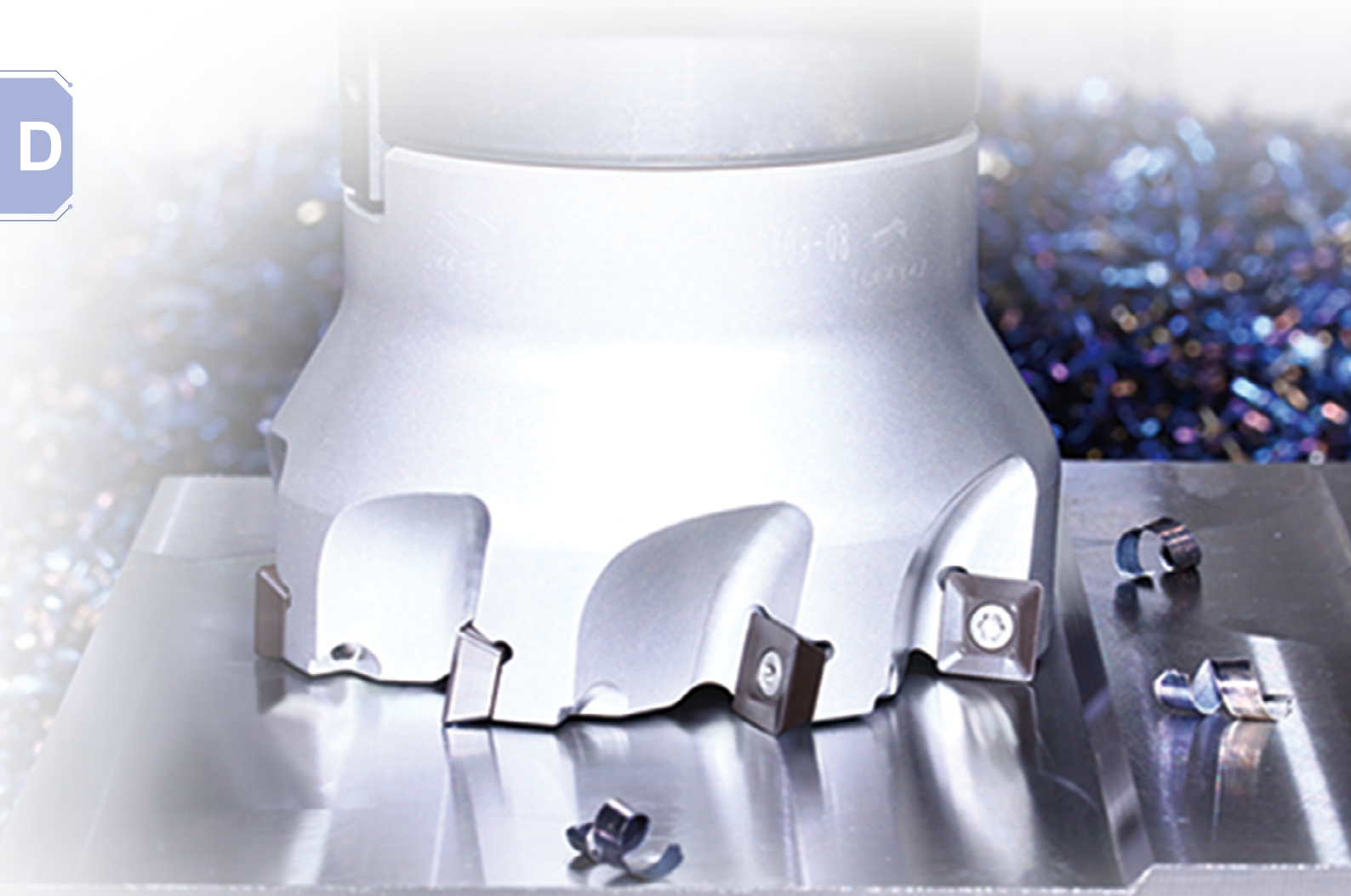

D

Face milling tools **Kr:90°**



FMP03 **P** **M** **K**

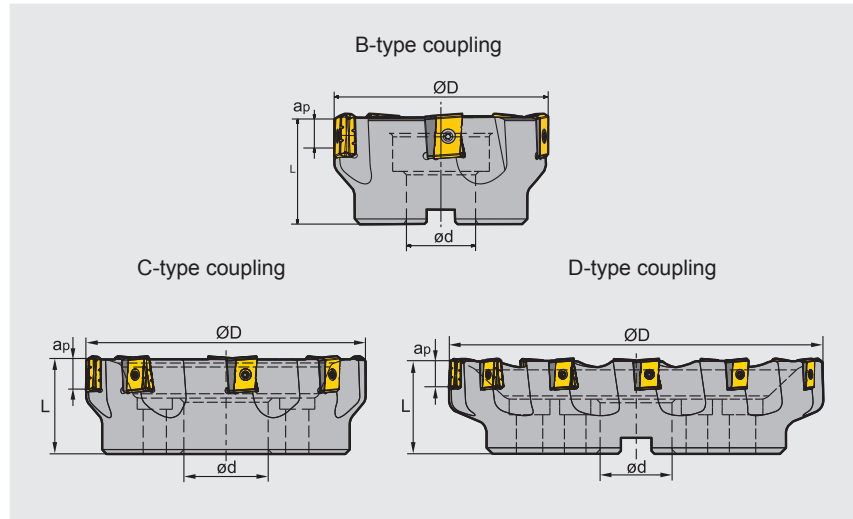

Specification of tools

Type		Dimensions(inch)					
		ØD	Ød	L	apmax	Z	Interface form
FMP03	-5.00"-B1.5"-LN15-06	5.00	1.50	2.50	0.512	6	B
	-6.00"-C1.5"-LN15-08	6.00	1.50	2.50	0.512	8	C
	-8.00"-C2.5"-LN15-10	8.00	2.50	2.75	0.512	10	C
	-10.00"-C2.5"-LN15-12	10.00	2.50	2.75	0.512	12	C
	-12.00"-D2.5"-LN15-16	12.00	2.50	3.15	0.512	16	D
	-5.00"-B1.5"-LN20-06	5.00	1.50	2.50	0.669	6	B
	-6.00"-C1.5"-LN20-08	6.00	1.50	2.50	0.669	8	C
	-8.00"-C2.5"-LN20-10	8.00	2.50	2.75	0.669	10	C
	-10.00"-C2.5"-LN20-12	10.00	2.50	2.75	0.669	12	C
	-12.00"-D2.5"-LN20-15	12.00	2.50	3.15	0.669	15	D
	-5.00"-B1.5"-LN25-05	5.00	1.50	2.50	0.866	5	B
	-6.00"-C1.5"-LN25-06	6.00	1.50	2.50	0.866	6	C
-8.00"-C2.5"-LN25-08	8.00	2.50	2.75	0.866	8	C	
-10.00"-C2.5"-LN25-10	10.00	2.50	2.75	0.866	10	C	
-12.00"-D2.5"-LN25-12	12.00	2.50	3.15	0.866	12	D	

Spare parts

Diameter ØD	Shim	Shim screw	Insert screw	Wrench		Sketch of installation
LNKT1506EN-ZR	LLN15-ZR	I60M3×7	I60M4×12	WT15IS	WT09IS	
LNKT2007DN-ZR	LLN20R-ZR	I60M3×7	I60M4×15	WT15IS	WT09IS	
LNKT2510-ZR	LLN25R-ZR	I60M3.5×10.4	I60M5×17	WT20IT	WT15IS	

Face milling tools

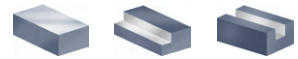

FMP12 P K

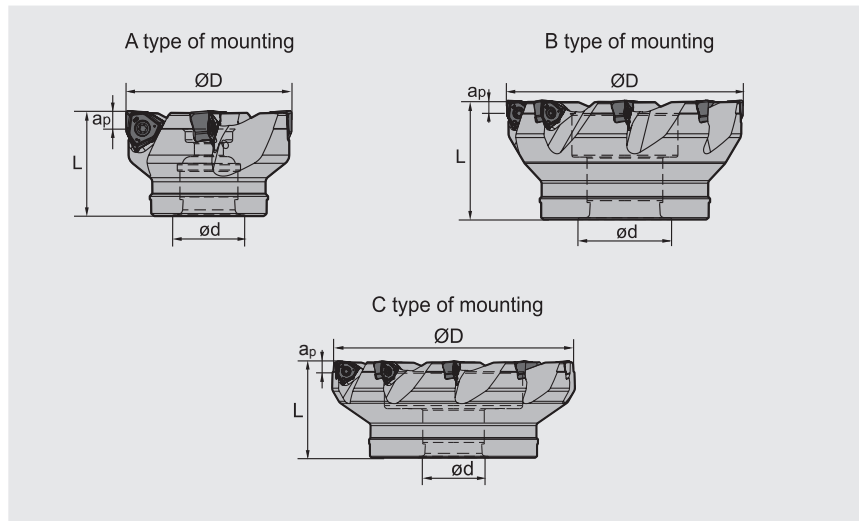

Specification of tools

Type		Dimensions (inch)					
		ØD	Ød	L	apmax	Z	Interface form
FMP12	-2.00"-A0.75"-WN06-05C	2.00	0.75	1.75	0.224	5	A
	-2.50"-A0.75"-WN06-06C	2.50	0.75	1.75	0.224	6	A
	-2.50"-A1.00"-WN06-06C	2.50	1.00	2.00	0.224	6	A
	-3.00"-A1.00"-WN06-07C	3.00	1.00	2.00	0.224	7	A
	-4.00"-B1.25"-WN06-09	4.00	1.25	2.00	0.224	9	B
	-5.00"-B1.50"-WN06-11	5.00	1.50	2.50	0.224	11	B
	-6.00"-C1.50"-WN06-14	6.00	1.50	2.50	0.224	14	C
	-2.50"-A0.75"-WN08-05C	2.50	0.75	1.75	0.303	5	A
	-2.50"-A1.00"-WN08-05C	2.50	1.00	2.00	0.303	5	A
	-3.00"-A1.00"-WN08-06C	3.00	1.00	2.00	0.303	6	A
	-4.00"-B1.25"-WN08-08	4.00	1.25	2.00	0.303	8	B
	-5.00"-B1.50"-WN08-10	5.00	1.50	2.50	0.303	10	B
-6.00"-C1.50"-WN08-12	6.00	1.50	2.50	0.303	12	C	

Spare parts

Inserts	Insert tightening screw	Wrench	Sketch of installation
WNHU06	I60M3×9	WT09IS	
WNHU08	I60M4×10	WT15IS	

Face milling tools

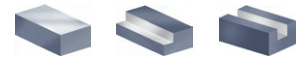

FMP12 P K

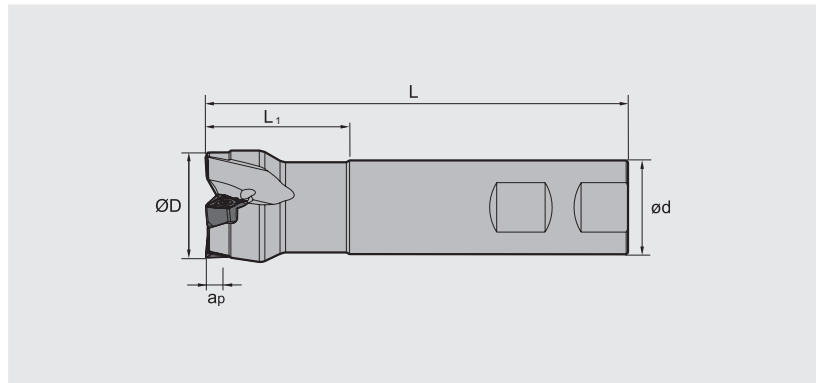

Specification of tools

Type		Dimensions(inch)					
		ØD	ød	L	L ₁	a _p max	Z
FMP12	-1.00"-XP1.00"-WN06-02C	1.00	1.00	4.0	1.25	0.224	2
	-1.25"-XP1.00"-WN06-03C	1.25	1.00	4.5	1.50	0.224	3
	-1.50"-XP1.25"-WN06-04C	1.50	1.25	4.5	1.50	0.224	4
	-2.00"-XP1.50"-WN06-05C	2.00	1.50	4.5	1.50	0.224	5

Spare parts

Inserts	Insert tightening screw	Wrench	Sketch of installation
WNHU06	I60M3×9	WT09IS	
WNHU08	I60M4×10	WT15IS	

Face milling tools



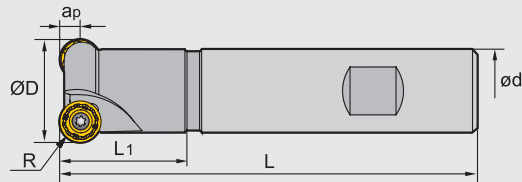

FMR01 **P** **M** **K**



Specification of tools

Type		Dimensions(inch)						
		$\varnothing D$	R	$\varnothing d$	L_1	L	a_{pmax}	Z
FMR01	-1.00"-XP0.75" -RC10-02	1.00	0.197	0.75	1.75	4.00	0.197	2
	-1.25"-XP1.00" -RC10-02	1.25	0.197	1.00	2.50	4.75	0.197	2
	-1.50"-XP1.25" -RC12-03	1.50	0.236	1.25	2.50	4.75	0.236	3
	-2.00"-XP1.25" -RC12-03	2.00	0.236	1.25	2.50	4.75	0.236	3

Spare parts

Diameter $\varnothing D$	Insert specification	Insert screw	Wrench	Sketch of installation
$\varnothing D=1.00", 1.25"$	RCKT10T3MO-DM	 I60M4×8.4	 WT15S	
$\varnothing D=1.50", 2.00"$	RCKT1204MO-□□	I60M3.5×10	WT15S	

Face milling tools



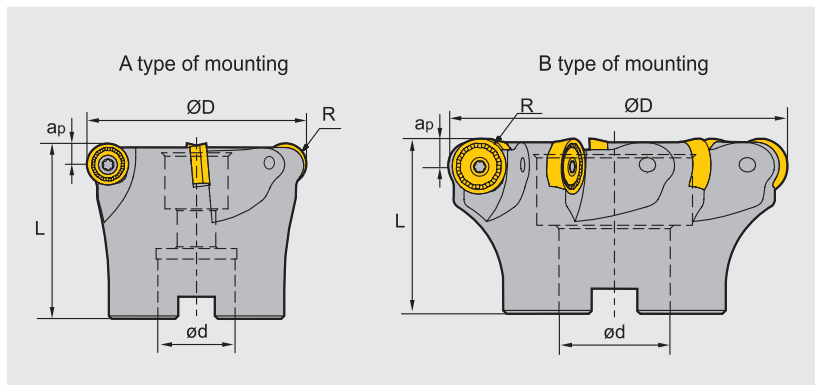

FMR02 P M K S



Specification of tools

Type		Dimensions(inch)						
		ØD	R	ød	L	apmax	Z	Interface form
FMR02	-2.50"-A0.75"-RC12-04	2.50	0.236	0.75	2.00	0.236	4	A
	-3.00"-B1.00"-RC16-05	3.00	0.315	1.00	2.00	0.315	5	B
	-4.00"-B1.25"-RC16-06	4.00	0.315	1.25	2.50	0.315	6	B
	-5.00"-B1.50"-RC20-07	5.00	0.394	1.50	2.50	0.394	7	B
	-6.00"-B1.50"-RC20-08	6.00	0.394	1.50	2.50	0.394	8	B

Spare parts

Diameter ØD	Insert specification	Insert screw	Wrench	Sketch of installation
				
ØD=2.50"	RC□□1204MO-□□	I60M3.5×10	WT15IS	
ØD=3.00",4.00"	RC□□1606MO-□□	I60M5×13	WT20IT	
ØD=5.00",6.00"	RC□□2006MO-□□	I43M6×16	WT25IT	

Face milling tools



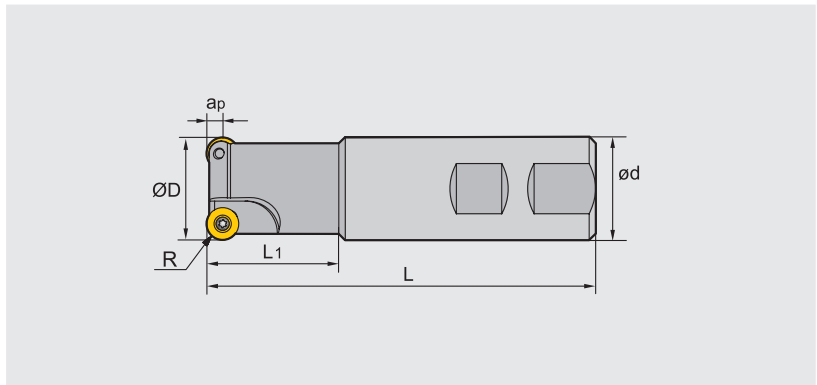

FMR03 P M K



Specification of tools

Type		Dimensions(inch)						
		ØD	R	ød	L1	L	apmax	Z
FMR03	-1.00"-XP1.00" -RD08-02	1.00	0.157	1.00	1.75	4.00	0.157	2
	-1.25"-XP1.25" -RD10-02	1.25	0.197	1.25	2.50	4.75	0.197	2
	-1.50"-XP1.25" -RD12-03	1.50	0.236	1.25	2.50	4.75	0.236	3
	-2.00"-XP1.25" -RD12-03	2.00	0.236	1.25	2.50	4.75	0.236	3

Spare parts

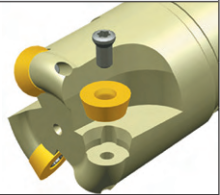
Diameter ØD	Insert specification	Insert screw	Wrench	Sketch of installation
				
ØD=1.00"	RDKW0803MO	I60M3×7	WT09IP	
ØD=1.25", 1.50", 2.00"	RDKW1073MO RDKW1204MO	I60M4×10	WT15IP	

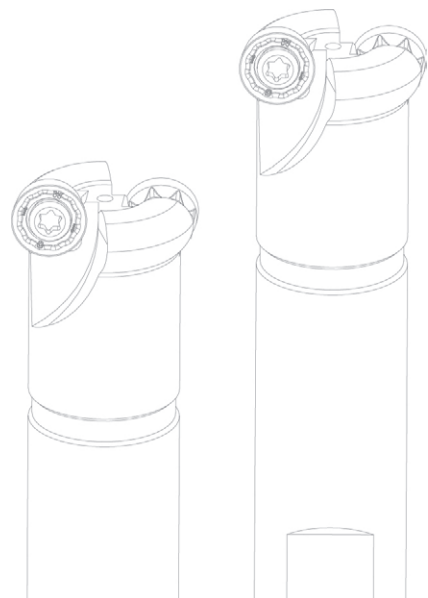

Face milling tools





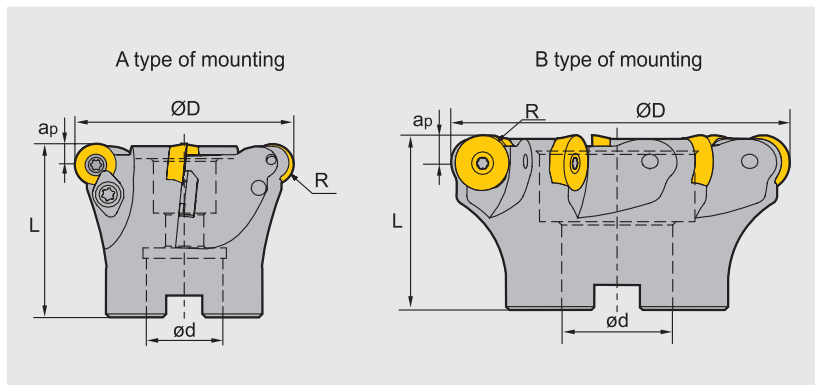

FMR04 P M K



Specification of tools

Type		Dimensions(inch)						
		ØD	R	ød	L	apmax	Z	Interface form
FMR04	-2.00"-A0.75"-RD12-04	2.00	0.236	0.75	2.00	0.236	4	A
	-2.50"-A0.75"-RD12-04	2.50	0.236	0.75	2.00	0.236	4	A
	-3.00"-A1.00"-RD16-05	3.00	0.315	1.00	2.00	0.315	5	A
	-4.00"-B1.25"-RD16-06	4.00	0.315	1.25	2.00	0.315	6	B
	-5.00"-B1.50"-RD20-06	5.00	0.394	1.50	2.50	0.394	6	B
	-6.00"-B1.50"-RD20-07	6.00	0.394	1.50	2.50	0.394	7	B

Spare parts

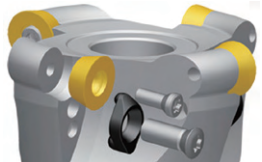
Diameter ØD	Insert screw	Wedge	Wedge Screw	Wrench	Sketch of installation
ØD=2.00" ØD=2.50"	 I60M3.5×10	 WD-204	 I60M4×10	 WT15IT	
ØD=3.00",4.00"	I60M5×13	WD-207	I60M5×13	WT20IT	
ØD=5.00",6.00"	I43M6×16	--	--	WT25IT	



Face milling tools



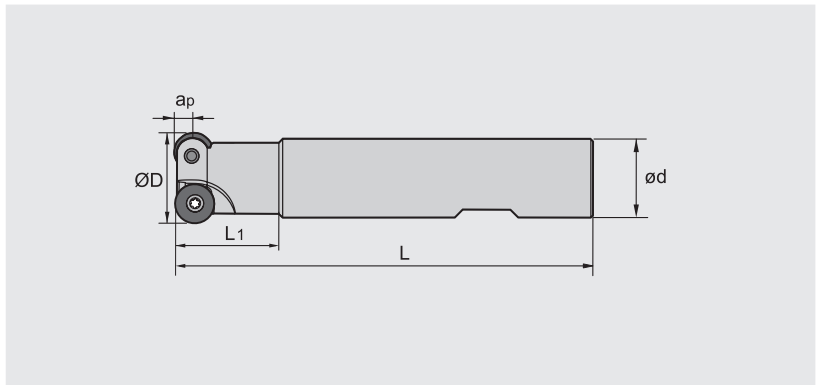
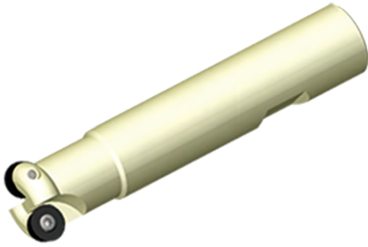

FMR05 P M K



Specification of tools

Type		Dimensions(inch)					
		ØD	Ød	L1	L	apmax	Z
FMR05	-0.625"-XP0.75"-RP06-02	0.625	0.75	1.75	4	0.125	2
	-0.750"-XP0.75"-RP06-02	0.750	0.75	1.75	4	0.125	2
	-0.875"-XP0.75"-RP06-03	0.875	0.75	1.75	4	0.125	3
	-0.875"-XP0.75"-RP09-02	0.875	0.75	1.75	4	0.180	2
	-1.000"-XP0.75"-RP09-02	1.000	0.75	1.75	4	0.180	2
	-1.250"-XP1.00"-RP09-03	1.250	1.00	2.75	5	0.180	3
	-1.250"-XP1.00"-RP12-02	1.250	1.00	2.75	5	0.250	2
	-1.500"-XP1.25"-RP12-03	1.500	1.25	2.75	5	0.250	3
	-1.750"-XP1.50"-RP12-04	1.750	1.50	2.75	5	0.250	4

Spare parts

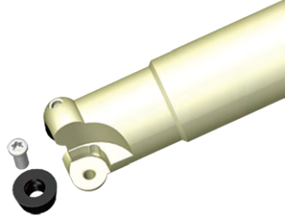
Diameter ØD	Insert specification	Insert screw	Wrench	Sketch of installation
				
Ø0.625"-Ø0.875"	RPMW06T200	I60M2.2×5.5	WT07IP	
Ø0.875"-Ø1.250"	RPMW09T300	I60M3×7	WT09IP	
Ø1.250"-Ø1.750"	RPMW120400	I60M4×8.4	WT15IP	

Face milling tools



FMR05 P M K



A type of mounting

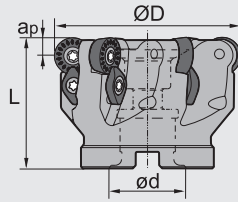

B type of mounting

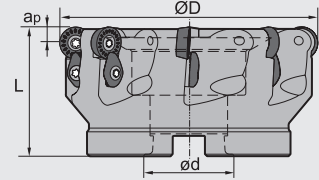



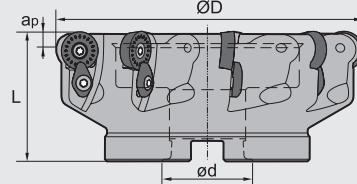

C type of mounting



Specification of tools

Type		Dimensions(inch)					Interface form
		ØD	Ød	L	apmax	Z	
FMR05	-2.00"-A0.75"-RP12-05	2.0	0.75	1.75	0.250	5	A
	-2.50"-A0.75"-RP12-06	2.5	0.75	1.75	0.250	6	A
	-3.00"-A1.00"-RP12-07	3.0	1.00	2.00	0.250	7	A
	-3.00"-A1.00"-RP16-05	3.0	1.00	2.00	0.315	5	A
	-4.00"-B1.50"-RP16-07	4.0	1.50	2.50	0.315	7	B
	-5.00"-B1.50"-RP16-08	5.0	1.50	2.50	0.315	8	B
	-5.00"-B1.50"-RP19-07	5.0	1.50	2.50	0.375	7	B
	-6.00"-B2.00"-RP19-08	6.0	2.00	2.50	0.375	8	B
	-8.00"-C2.50"-RP19-09	8.0	2.50	2.50	0.375	9	C

Spare parts

Diameter ØD	Insert specification	Insert screw	Wedge	Wedge Screw	Wrench	Sketch of installation
						
Ø2.00"-Ø3.00"	RPMW120400	I60M4×8.4	WD-204	I60M4×10	WT15IP	
Ø3.00"-Ø5.00"	RPMW160500	I60M5×13	WD-208	I60M5×13	WT20IP	
Ø5.00"-Ø8.00"	RPMW190600					

Square shoulder milling tools **Kr:90°**



EMP01 **P** **M** **N**

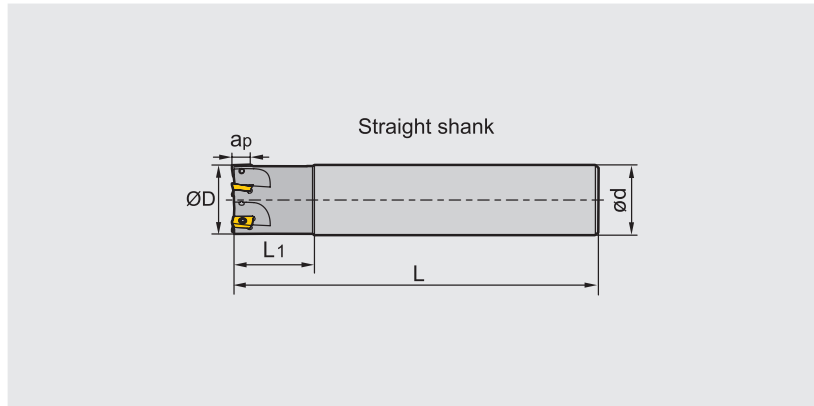

Specification of tools

Type		Dimensions(inch)					
		$\varnothing D$	$\varnothing d$	L_1	L	a_{pmax}	Z
EMP01 Cylindrical	-0.50"-G0.625"-AP11-01	0.50	0.625	1.00	3.50	0.433	1
	-0.625"-G0.625"-AP11-02	0.625	0.625	1.00	3.50	0.433	2
	-0.75"-G0.75"-AP11-02	0.75	0.75	1.25	4.00	0.433	2
	-0.75"-G0.75"-AP11-02(L=6.5")	0.75	0.75	3.50	6.50	0.433	2
	-0.75"-G0.75"-AP11-02(L=10")	0.75	0.75	1.25	10.0	0.433	2
	-1.00"-G1.00"-AP11-03	1.00	1.00	1.50	4.50	0.433	3
	-1.25"-G1.25"-AP11-04	1.25	1.25	1.50	5.00	0.433	4
	-1.00"-G1.00"-AP16-02	1.00	1.00	1.50	4.50	0.630	2
	-1.00"-G1.00"-AP11-03 (L=10")	1.00	1.00	1.50	10.0	0.433	3
	-1.00"-G1.00"-AP11-03 (L=6.5")	1.00	1.00	3.50	6.50	0.433	3
	-1.00"-G1.00"-AP16-02 (L=7")	1.00	1.00	4.00	7.00	0.630	2
	-1.00"-G1.00"-AP16-02 (L=10")	1.00	1.00	1.50	10.0	0.630	2
	-1.25"-G1.25"-AP16-03	1.25	1.25	1.50	5.00	0.630	3
	-1.25"-G1.25"-AP11-04 (L=10")	1.25	1.25	1.50	10.0	0.433	4
	-1.25"-G1.25"-AP16-03 (L=7")	1.25	1.25	4.00	7.00	0.630	3
	-1.25"-G1.25"-AP16-03 (L=10")	1.25	1.25	1.50	10.0	0.630	3
	-1.50"-G1.25"-AP16-04	1.50	1.25	1.75	5.00	0.630	4
	-1.50"-G1.25"-AP16-04 (L=7")	1.50	1.25	1.75	7.00	0.630	4
	-1.50"-G1.25"-AP16-04 (L=10")	1.50	1.25	1.75	10.0	0.630	4
	-1.50"-G1.50"-AP16-04 (L=7")	1.50	1.50	4.00	7.00	0.630	4
-2.00"-G1.25"-AP16-05	2.00	1.25	1.75	5.50	0.630	5	
-2.50"-G1.25"-AP16-06	2.50	1.25	1.75	5.50	0.630	6	



Square shoulder milling tools **Kr:90°**



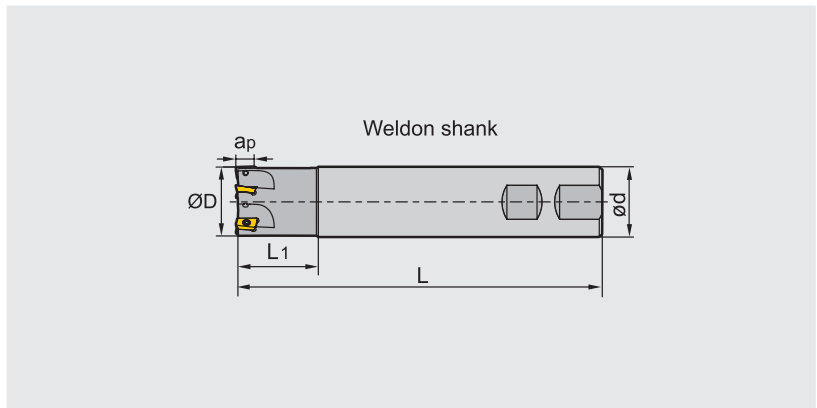

EMP01 **P M N**



Specification of tools

Type		Dimensions(inch)					
		ØD	Ød	L1	L	apmax	Z
EMP01 Weldon	-0.50"-XP0.625"-AP11-01	0.50	0.625	1.25	3.50	0.433	1
	-0.625"-XP0.625"-AP11-02	0.625	0.625	1.25	3.50	0.433	2
	-0.75"-XP0.75"-AP11-02	0.75	0.75	1.75	4.00	0.433	2
	-0.75"-XP0.75"-AP11-03	0.75	0.75	1.75	4.00	0.433	3
	-1.00"-XP1.00"-AP11-03	1.00	1.00	2.25	4.50	0.433	3
	-1.25"-XP1.25"-AP11-04	1.25	1.25	2.75	5.00	0.433	4
	-1.00"-XP1.00"-AP16-02	1.00	1.00	2.25	4.50	0.630	2
	-1.25"-XP1.25"-AP16-03	1.25	1.25	2.75	5.00	0.630	3
	-1.50"-XP1.25"-AP16-04	1.50	1.25	1.75	5.00	0.630	4
	-2.00"-XP1.25"-AP16-05	2.00	1.25	1.75	5.50	0.630	5
	-2.50"-XP1.25"-AP16-06	2.50	1.25	1.75	5.50	0.630	6
	-1.00"-XPL1.00"-AP16-02	1.00	1.00	4.25	6.50	0.630	2
	-1.00"-XPL1.00"-AP16-02	1.00	1.00	5.75	8.00	0.630	2
	-1.25"-XPL1.25"-AP16-03	1.25	1.25	4.25	6.50	0.630	3
	-1.25"-XPL1.25"-AP16-03	1.25	1.25	6.25	8.50	0.630	3

Spare parts

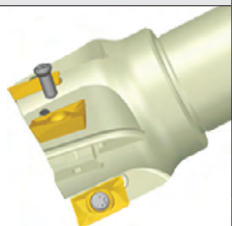
Diameter ØD	Insert specification	screw	Wrench	Sketch of installation
				
ØD=0.50 "~1.25"	AP11	I60M2.5×6.5T	WT08IP	
ØD=1.00 "~2.50"	AP16	I60M4×8.4	WT15IS	

Selection of inserts

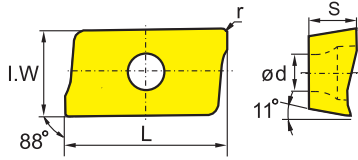

😊 Good working conditions 😊 General working conditions ☹️ Adverse working conditions

Workpiece material	P Steel	M Stainless steel	K Cast iron	N Ferrite materials	S Heat-resistant steel
YBC302	😊	😊	😊	😊	😊
YBM251	😊	😊	😊	😊	😊
YBM253	😊	😊	😊	😊	😊
YBM351	😊	😊	😊	😊	😊
YBD152	😊	😊	😊	😊	😊
YBD252	😊	😊	😊	😊	😊
YBG102	😊	😊	😊	😊	😊
YBG202	😊	😊	😊	😊	😊
YBG205	😊	😊	😊	😊	😊
YB9320	😊	😊	😊	😊	😊
YBG302	😊	😊	😊	😊	😊
YBG152	😊	😊	😊	😊	😊
YBG252	😊	😊	😊	😊	😊
YNG151	😊	😊	😊	😊	😊
YNG151C	😊	😊	😊	😊	😊
YC30S	😊	😊	😊	😊	😊
YD051	😊	😊	😊	😊	😊
YD101	😊	😊	😊	😊	😊
YD201	😊	😊	😊	😊	😊

Insert shape	Type	Dimensions (inch)					Coated grade										Cermet		Cemented carbide								
		L	I.W	S	ød	r	YBC302	YBM251	YBM253	YBM351	YBD152	YBD252	YBG102	YBG202	YBG205	YB9320	YBG302	YBG152	YBG252	YNG151	YNG151C	YC30S	YD051	YD101	YD201		
	APKT11T304-APF	0.482	0.256	0.142	0.110	0.016										●											
	APKT11T308-APF	0.482	0.256	0.142	0.110	0.031										●											
	APKT160408-APF	0.704	0.367	0.227	0.173	0.031										●											
	APKT11T304-APM	0.482	0.256	0.142	0.110	0.016										●											
	APKT11T308-APM	0.482	0.256	0.142	0.110	0.031										●											
	APKT11T312-APM	0.482	0.256	0.142	0.110	0.047										●											
	APKT11T316-APM	0.482	0.256	0.142	0.110	0.063										●											
	APKT11T320-APM	0.482	0.256	0.142	0.110	0.079										●											
	APKT160408-APM	0.704	0.367	0.227	0.173	0.031										●											
	APKT160416-APM	0.704	0.367	0.227	0.173	0.063										●											
	APKT160420-APM	0.704	0.367	0.227	0.173	0.079										●											
	APKT160424-APM	0.704	0.367	0.227	0.173	0.094										●											
	APKT160430-APM	0.704	0.367	0.227	0.173	0.118										●											
	APKT11T304-ALH	0.482	0.256	0.142	0.110	0.016																		●	●		
	APKT11T308-ALH	0.482	0.256	0.142	0.110	0.031																		●	○		
	APKT160408-ALH	0.704	0.367	0.227	0.173	0.031																		●	●		

● Always stock available ○ Produce according to order



Chipbreaker selection

Classification	Function	For finishing	For Semi-finishing
P		-APF	-APM
M		-APF	-APM
AL		-ALH	

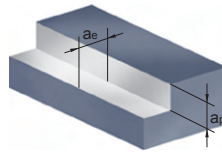

1 Square shoulder milling

Recommended cutting parameters

(D: Diameter)

Workpiece material	Hardness HB	Insert grade	Cutting parameters			
			V(SFPM)	f(in/z)		ae(inch)
				-APF	-APM	
P Low-carbon steel, Soft steel	≤ 180	YB9320	1000(650-1300)	0.004(0.003-0.008)	0.008(0.004-0.012)	≤ 0.5D
	180-280	YB9320	900(600-1100)	0.004(0.003-0.008)	0.008(0.004-0.012)	≤ 0.5D
	280-350	YB9320	850(500-1100)	0.004(0.003-0.008)	0.008(0.004-0.012)	≤ 0.5D
M Stainless steel	≤ 270	YB9320	650(360-1000)	0.004(0.003-0.008)	0.008(0.004-0.012)	≤ 0.5D
N Aluminium alloy	----			-ALH		
		YD101	1000-	0.008(0.003-0.016)	≤ 0.5D	
		YD201	1000-	0.008(0.003-0.016)	≤ 0.5D	

D

2 Slot milling

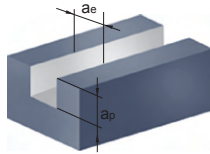

Recommended cutting parameters (D: Diameter)

Workpiece material	Hardness HB	Insert grade	Cutting parameters			
			V(SFPM)	f(in/z)		ae(inch)
				-APF	-APM	
P Low-carbon steel, Soft steel	≤ 180	YB9320	600(450-800)	0.004(0.003-0.006)	0.006(0.004-0.01)	D
	180-280	YB9320	550(400-800)	0.004(0.003-0.006)	0.006(0.004-0.01)	D
	280-350	YB9320	500(360-800)	0.004(0.003-0.006)	0.006(0.004-0.01)	D
M Alloy tool steel	≤ 270	YB9320	400(260-600)	0.004(0.003-0.006)	0.006(0.004-0.01)	D
N Aluminium alloy	----			-ALH		
		YD101	1000-	0.008(0.003-0.012)	D	
		YD201	1000-	0.008(0.003-0.012)	D	

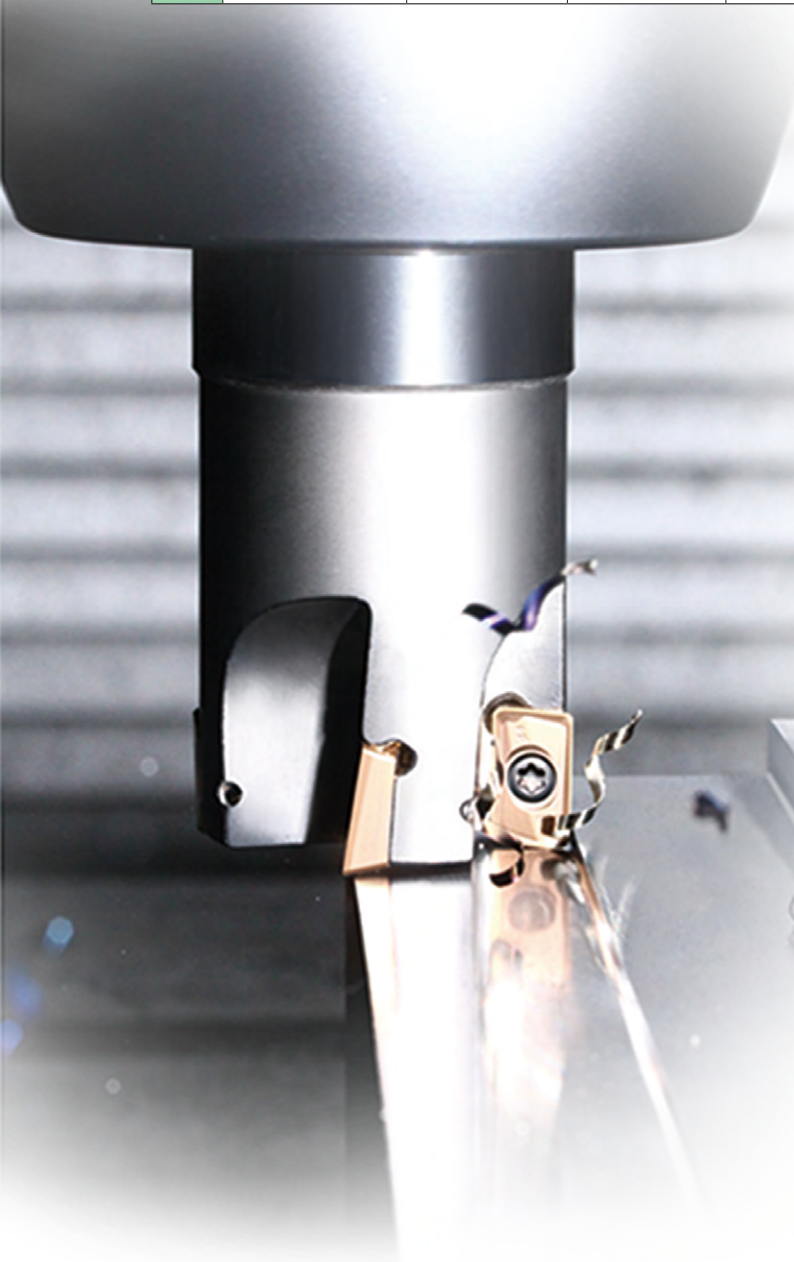

D

3 Ramp milling, helical interpolation milling

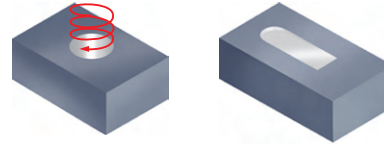

Recommended cutting parameters (D: Diameter)

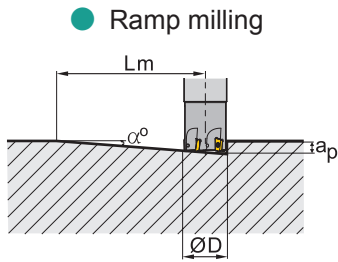

$$L_m = \frac{a_p}{\tan \alpha} \quad (\alpha: \text{Maximum ramp angle})$$

● Helical interpolation milling

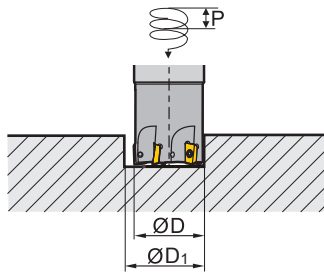

$$\tan \alpha = \frac{P}{\pi D_1} \quad (\alpha: \text{Helical angle})$$

Diameter ØD(mm)	APKT Ramp milling, helical interpolation milling (Inserts-11)				
	Ramp milling			Helical interpolation milling	
	Maximum cutting depth a_p (inch)	Maximum ramp angle α°	Minimum length L_m (inch)	Minimum diameter $\text{Ø}D_1$ (inch)	Maximum pitch(inch)
0.62	0.394	10.0	2.232	0.787	0.079
0.75	0.394	5.0	4.504	1.102	0.079
1	0.394	4.5	5.000	1.575	0.079
1.25	0.394	3.0	7.512	2.205	0.079
1.5	0.394	2.0	11.276	2.756	0.079

Note: For cutting speed and feed rate per tooth, see square shoulder milling.

Square shoulder milling tools **Kr:90°**



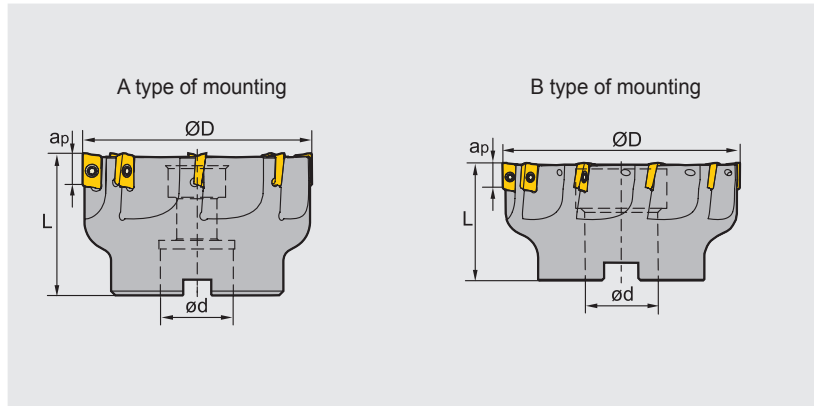

EMP02 **P** **M** **N**



Specification of tools

Type		Dimensions(inch)					
		ØD	ød	L	ap	Z	Interface form
EMP02	-2.00"-A0.75"-AP11-06	2.00	0.75	1.50	0.433	6	A
	-2.50"-A0.75"-AP11-08	2.50	0.75	1.50	0.433	8	A
	-3.00"-A1.00"-AP11-08	3.00	1.00	2.00	0.433	8	A
	-4.00"-B1.25"-AP11-10	4.00	1.25	2.00	0.433	10	B
	-2.00"-A0.75"-AP16-05	2.00	0.75	1.50	0.630	5	A
	-2.50"-A0.75"-AP16-06	2.50	0.75	1.50	0.630	6	A
	-3.00"-A1.00"-AP16-07	3.00	1.00	2.00	0.630	7	A
	-4.00"-B1.25"-AP16-08	4.00	1.25	2.00	0.630	8	B
	-5.00"-B1.50"-AP16-08	5.00	1.50	2.50	0.630	8	B
	-6.00"-B1.50"-AP16-09	6.00	1.50	2.50	0.630	9	B
	-8.00"-C2.50"-AP16-12	8.00	2.50	2.50	0.630	12	C

Spare parts

Diameter ØD	Inserts	Screw	Wrench	Sketch of installation
				
Ø=2"~4"	AP11	I60M2.5×6.5T	WT08IS	
Ø=2"~4"	AP16	I60M4×10	WT15IS	
Ø=5"~8"	AP16	I60M4×10	WT15IS	

Selection of inserts

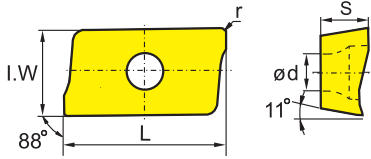

😊 Good working conditions 😊 General working conditions 😞 Adverse working conditions

Workpiece material	P Steel	M Stainless steel	K Cast iron	N Ferrite materials	S Heat-resistant steel
P Steel	😊	😊	😊	😊	😊
M Stainless steel	😊	😊	😊	😊	😊
K Cast iron	😊	😊	😊	😊	😊
N Ferrite materials	😊	😊	😊	😊	😊
S Heat-resistant steel	😊	😊	😊	😊	😊

Insert shape	Type	Dimensions (inch)					Coated grade										Cermets		Cemented carbide						
		L	I.W	S	ød	r	YBC302	YBM251	YBM253	YBM351	YBD152	YBD252	YBG102	YBG202	YBG205	YB9320	YBG302	YBG152	YBG252	YNG151	YNG151C	YC30S	YD051	YD101	YD201
	APKT11T304-APF	0.482	0.256	0.142	0.110	0.016										●									
	APKT11T308-APF	0.482	0.256	0.142	0.110	0.031										●									
	APKT160408-APF	0.704	0.367	0.227	0.173	0.031										●									
	APKT11T304-APM	0.482	0.256	0.142	0.110	0.016										●									
	APKT11T308-APM	0.482	0.256	0.142	0.110	0.031										●									
	APKT11T312-APM	0.482	0.256	0.142	0.110	0.047										●									
	APKT11T316-APM	0.482	0.256	0.142	0.110	0.063										●									
	APKT11T320-APM	0.482	0.256	0.142	0.110	0.079										●									
	APKT160408-APM	0.704	0.367	0.227	0.173	0.031										●									
	APKT160416-APM	0.704	0.367	0.227	0.173	0.063										●									
	APKT160420-APM	0.704	0.367	0.227	0.173	0.079										●									
	APKT160424-APM	0.704	0.367	0.227	0.173	0.094										●									
	APKT160430-APM	0.704	0.367	0.227	0.173	0.118										●									
	APKT11T304-ALH	0.482	0.256	0.142	0.110	0.016																	●	●	
	APKT11T308-ALH	0.482	0.256	0.142	0.110	0.031																	●	○	
	APKT160408-ALH	0.704	0.367	0.227	0.173	0.031																	●	●	

● Always stock available ○ Produce according to order

Chipbreaker selection

Classification	Function	For finishing	For Semi-finishing
P		-APF	-APM
M		-APF	-APM
AL		-ALH	

Square shoulder milling

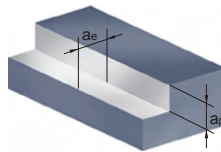

Recommended cutting parameters (D: Diameter)

Workpiece material	Hardness HB	Insert grade	Cutting parameters			
			V(SFPM)	f(in/z)		ae(inch)
				-APF	-APM	
P Low-carbon steel, Soft steel	≤ 180	YB9320	1000(650-1300)	0.004(0.003-0.008)	0.008(0.004-0.012)	≤ 0.5D
	180-280	YB9320	900(600-1100)	0.004(0.003-0.008)	0.008(0.004-0.012)	≤ 0.5D
	280-350	YB9320	850(500-1100)	0.004(0.003-0.008)	0.008(0.004-0.012)	≤ 0.5D
M Alloy tool steel	280-350	YB9320	850(500-1100)	0.004(0.003-0.008)	0.008(0.004-0.012)	≤ 0.5D
N Stainless steel	≤ 270	YB9320	650(360-1000)	0.004(0.003-0.008)	0.008(0.004-0.012)	≤ 0.5D
N Aluminium alloy	---	-ALH				
		YD101	1000-	0.008(0.003-0.016)		≤ 0.5D
		YD201	1000-	0.008(0.003-0.016)		≤ 0.5D

D

Square shoulder milling tools **Kr:90°**



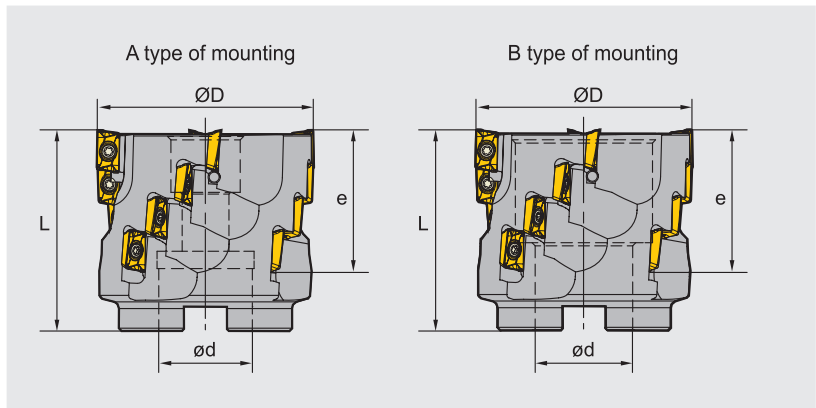

EMP03 P M N



Specification of tools

Type		Dimensions(inch)						
		ØD	ød	L	e	Z	Inserts total	Interface form
EMP03	-2.00"-A0.75"-AP11-04	2.00	0.75	2.5	1.535	4	16	A
	-2.50"-A1.00"-AP11-04	2.50	1.00	2.5	1.535	4	16	A
	-3.00"-B1.25"-AP11-05	3.00	1.25	2.5	1.535	5	20	B
	-4.00"-B1.50"-AP11-06	4.00	1.50	2.5	1.535	6	24	B

Spare parts

Inserts screw	Wrench	Sketch of installation
 I60M2.5×6.5T	 WT08IS	

Square shoulder milling tools **Kr:90°**

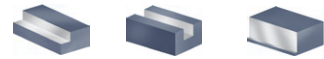

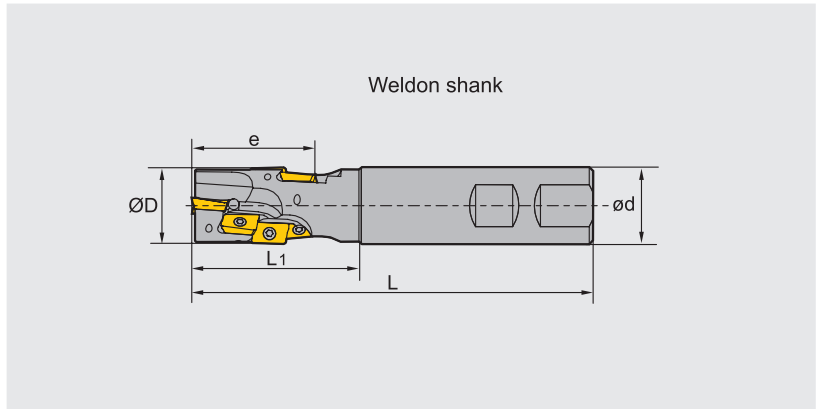

EMP04 **P** **M** **N**



Specification of tools

Type		Dimensions(inch)						
		$\varnothing D$	$\varnothing d$	L_1	L	e	Z	Inserts total
EMP04	-0.75" -XP0.75" -AP11-01	0.75	0.75	2.50	4.75	1.157	1	3
	-1.00" -XP1.00" -AP11-02	1.00	1.00	2.75	5.00	1.531	2	8
	-1.25" -XP1.25" -AP11-02	1.25	1.25	3.25	5.50	1.909	2	10
	-1.50" -XP1.50" -AP11-02	1.50	1.50	3.75	6.00	2.283	2	14

Spare parts

Insert screw	Wrench	Sketch of installation
 I60M2.5×6.5T	 WT08IS	
		

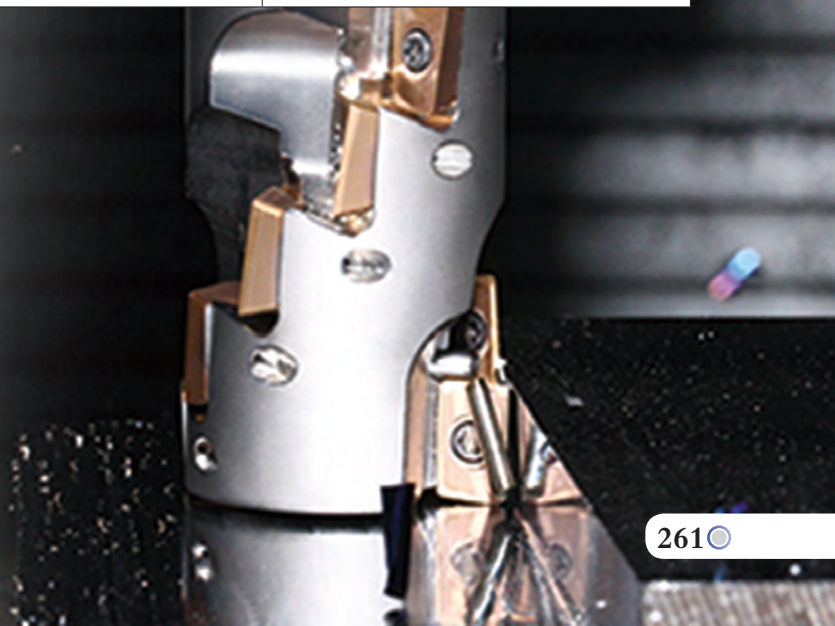

Recommended cutting parameters

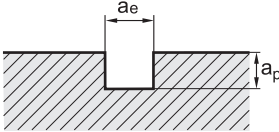
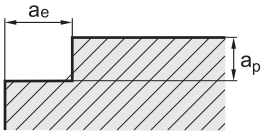
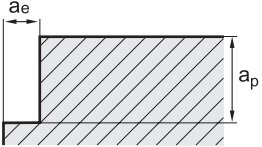
Slot milling	Square shoulder milling	Deep square shoulder milling
		
$a_e = D$ $a_p \leq 0.5D$	$a_e \leq 0.5D$ $a_p \leq 1.2D$	$a_e \leq 0.2D$ $a_p < \text{Cutting length of insert}$

Workpiece material	Hardness HB	Insert grade	Cutting parameters		
			Square shoulder milling		
			V(SFPM)	f(in/z)	
-APF	-APM				
P Low-carbon steel, Soft steel	≤ 180	YB9320	900(650-1200)	0.004(0.003-0.008)	0.008(0.004-0.012)
	180-280	YB9320	800(600-1200)	0.004(0.003-0.008)	0.008(0.004-0.012)
	280-350	YB9320	700(500-1100)	0.004(0.003-0.008)	0.008(0.004-0.012)
M Stainless steel	≤ 270	YB9320	500(360-900)	0.004(0.003-0.008)	0.008(0.004-0.012)
N Aluminium alloy	--	-ALH			
		YD101	1000-	0.008 (0.003-0.016)	
		YD201	1000-	0.008 (0.003-0.016)	

Kr:90°

**Achieving high quality
90° square shoulder milling**

EMP13 Series Square Shoulder Mills

Maximum cutting depth

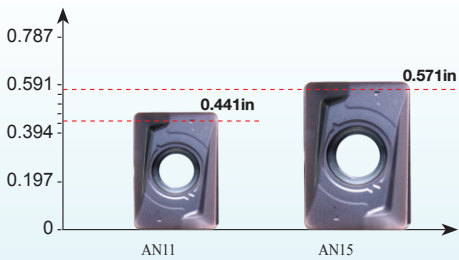

Extra thick insert with double negative cutter can achieve double positive cutting angle, reduce cutting force and greatly improve impact resistance.

Cutting edge properly designed with high precision control for high quality 90° square shoulder milling.

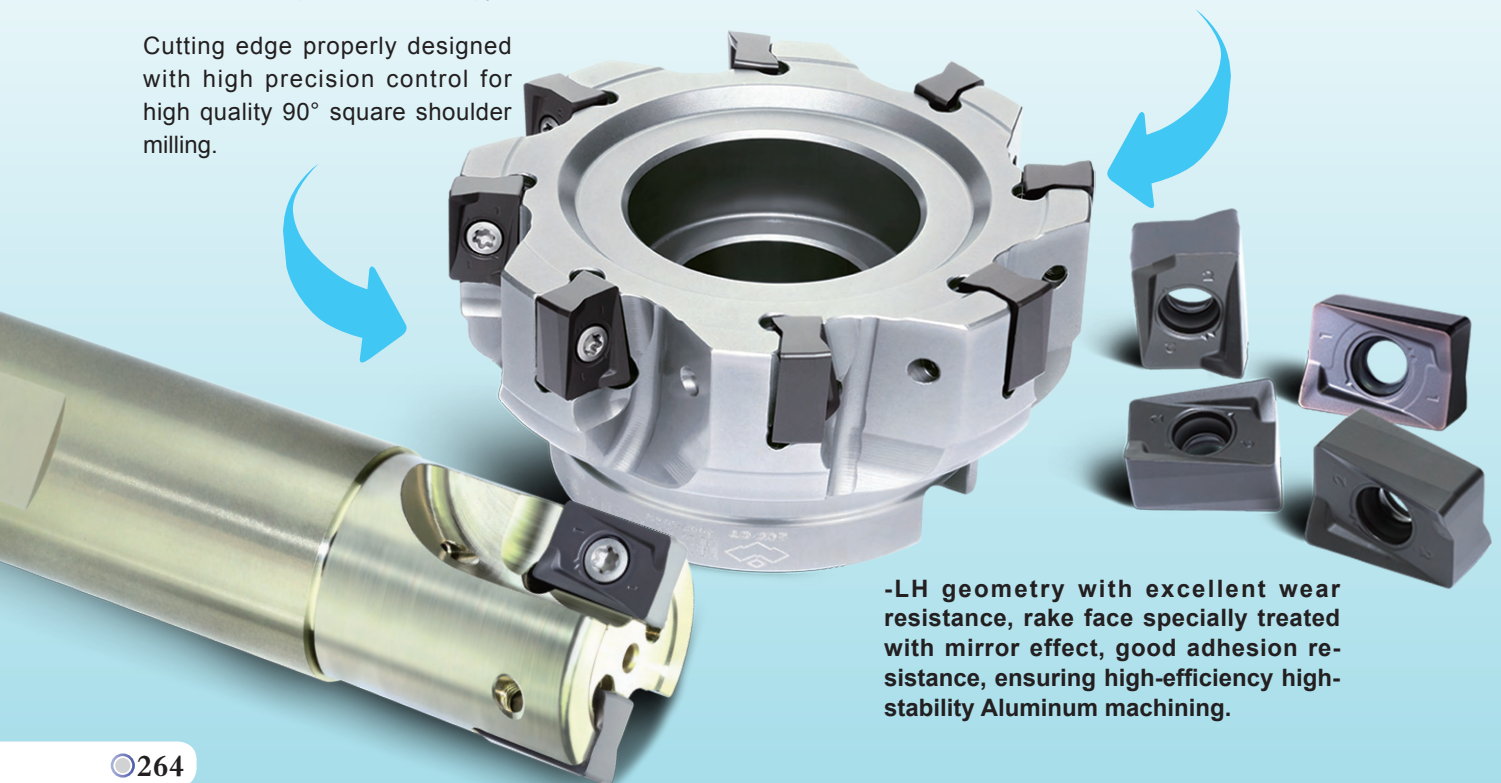

-LH geometry with excellent wear resistance, rake face specially treated with mirror effect, good adhesion resistance, ensuring high-efficiency high-stability Aluminum machining.

Square shoulder milling tools **Kr:90°**



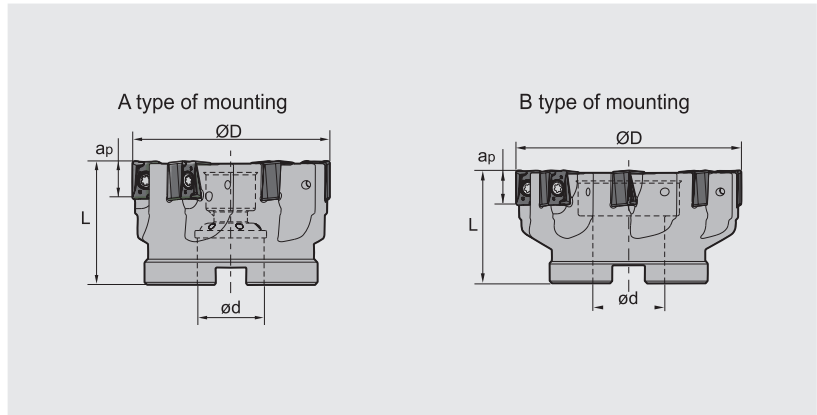

EMP13 **P** **K** **N**



Specification of tools

Type		Basic dimensions (inch)				Z	Interface form
		ØD	Ød	L	a _p max		
EMP13	-2.00"-A0.75"-AN11-06C	2.00	0.75	1.75	0.441	6	A
	-2.50"-A0.75"-AN11-07C	2.50	0.75	1.75	0.441	7	A
	-3.00"-A1.00"-AN11-09C	3.00	1.00	2.00	0.441	9	A
	-4.00"-B1.50"-AN11-12	4.00	1.50	2.50	0.441	12	B
	-5.00"-B1.50"-AN11-14	5.00	1.50	2.50	0.441	14	B
	-6.00"-B2.00"-AN11-16	6.00	2.00	2.50	0.441	16	B
	-2.00"-A0.75"-AN15-04C	2.00	0.75	1.75	0.571	4	A
	-2.50"-A0.75"-AN15-05C	2.50	0.75	1.75	0.571	5	A
	-3.00"-A1.00"-AN15-06C	3.00	1.00	2.00	0.571	6	A
	-4.00"-B1.50"-AN15-08	4.00	1.50	2.50	0.571	8	B
	-5.00"-B1.50"-AN15-10	5.00	1.50	2.50	0.571	10	B
	-6.00"-B2.00"-AN15-12	6.00	2.00	2.50	0.571	12	B

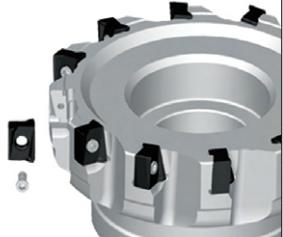
Spare parts

Diameter ØD	Insert specification	Insert screw	Wrench	
				
Ø2.00"-Ø6.00"	ANGX110504PNR-GM/LH	I60M3X9	WT09IS	
	ANGX110508PNR-GM/LH			
Ø2.00"-Ø6.00"	ANGX150608PNR-GM/LH	I60M4X12	WT15IS	
	ANGX150616PNR-GM/LH			

Square shoulder milling tools **Kr:90°**

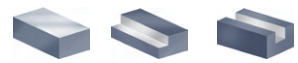

EMP13 **P** **K** **N**



Straight shank



Weldon shank

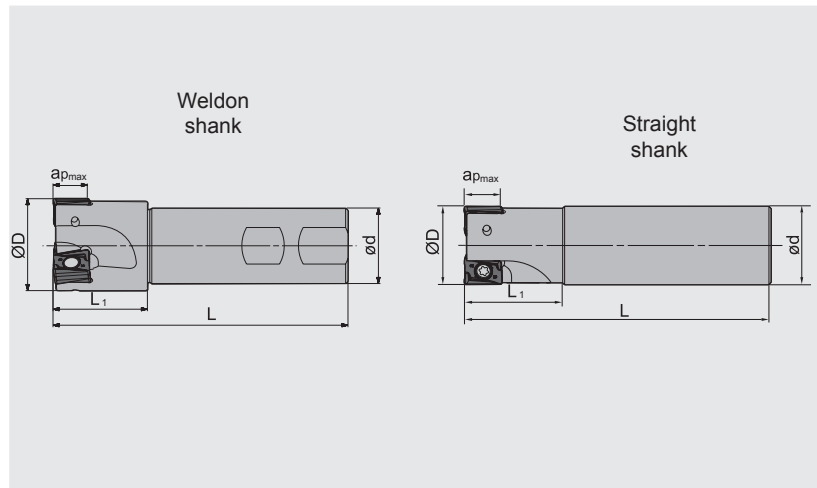

Specification of tools

Type		Basic dimensions (inch)					Z
		ØD	Ød	L	L ₁	a _{pmax}	
EMP13 Weldon shank	-0.75"-XP0.75"-AN11-01C	0.75	0.75	4.00	1.75	0.441	1
	-1.00"-XP1.00"-AN11-02C	1.00	1.00	4.50	2.25	0.441	2
	-1.25"-XP1.25"-AN11-03C	1.25	1.25	5.00	2.75	0.441	3
	-1.50"-XP1.25"-AN11-04C	1.50	1.25	5.00	1.50	0.441	4
	-1.25"-XP1.25"-AN15-02C	1.25	1.25	5.00	2.75	0.571	2
	-1.50"-XP1.25"-AN15-03C	1.50	1.25	5.00	1.50	0.571	3
straight shank	-0.75"-G0.75"-AN11-01C	0.75	0.75	4.00	1.25	0.441	1
	-1.00"-G1.00"-AN11-02C	1.00	1.00	4.50	1.50	0.441	2
	-1.25"-G1.25"-AN11-03C	1.25	1.25	5.00	1.50	0.441	3
	-1.50"-G1.25"-AN11-04C	1.50	1.25	5.00	1.75	0.441	4
	-1.25"-G1.25"-AN15-02C	1.25	1.25	5.00	1.50	0.571	2
	-1.50"-G1.25"-AN15-03C	1.50	1.25	5.00	1.75	0.571	3

Spare parts

Diameter ØD	Insert specification	Insert screw	Wrench	
Ø0.75"-Ø1.50"	ANGX110504PNR-GM/LH	 160M3X9	 WT09IS	
	ANGX110508PNR-GM/LH			
Ø0.75"-Ø1.50"	ANGX150608PNR-GM/LH	 160M4X12	 WT15IS	
	ANGX150616PNR-GM/LH			

Profile milling tools

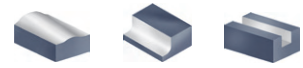

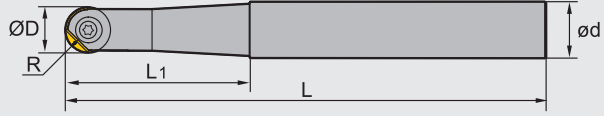

BMR02 P M K



Specification of tools

Type		Dimension(inch)					
		ØD	R	ød	L	L1	Z
BMR02	-12-G0.62" -S	0.472	0.236	0.625	4.50	1.50	2
	-12-G0.62" -M	0.472	0.236	0.625	5.00	2.00	2
	-12-G0.62" -L	0.472	0.236	0.625	6.00	2.00	2
	-16-G0.75" -S	0.630	0.315	0.75	6.00	1.75	2
	-16-G0.75" -M	0.630	0.315	0.75	6.50	2.50	2
	-16-G0.75" -L	0.630	0.315	0.75	8.00	2.50	2
	-20-G1.00" -S	0.787	0.394	1.00	6.50	2.50	2
	-20-G1.00" -M	0.787	0.394	1.00	8.00	3.00	2
	-20-G1.00" -L	0.787	0.394	1.00	9.50	3.00	2

Spare parts

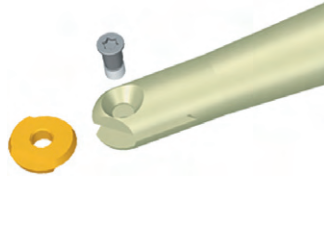
Diameter ØD	Insert specification	Screw	Wrench	Sketch of installation
				
ØD=0.472"	ROHX1203	I70M4×10TT	WT15IS	
ØD=0.630"	ROHX1604	I70M5×12TT	WT20IS	
ØD=0.787"	ROHX2005	I70M5×16TT	WT20IS	

Profile milling tools

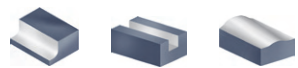

BMR04 P M K

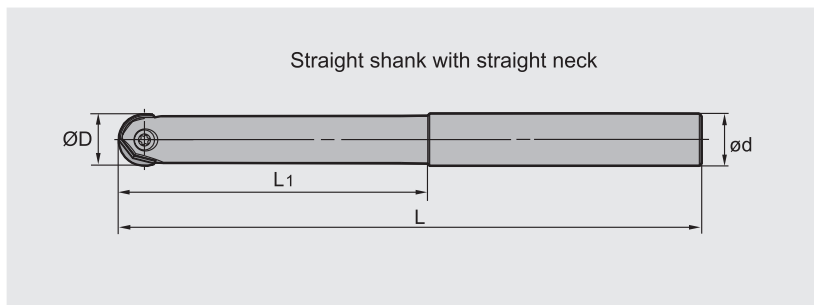



Specification of tools

Type		Dimensions(inch)				
		ØD	ød	L1	L	Z
BMR04	-0.625"-G0.625"-M	0.625	0.625	2.0	4.5	2
	-0.625"-G0.625"-L	0.625	0.625	3.0	6.5	2
	-0.75"-G0.75"-M	0.75	0.75	2.5	5.0	2
	-0.75"-G0.75"-L	0.75	0.75	3.5	7.0	2
	-1.00"-G1.00"-M	1.00	1.00	2.5	5.5	2
	-1.00"-G1.00"-L	1.00	1.00	3.5	8.0	2
	-1.00"-G1.00"-XL	1.00	1.00	5.0	10.0	2
	-1.25"-G1.25"-M	1.25	1.25	3.0	6.0	2
	-1.25"-G1.25"-L	1.25	1.25	4.0	9.0	2
	-1.25"-G1.25"-XL	1.25	1.25	5.0	12.0	2

D



Spare parts

Diameter ØD	Insert specification	Insert screw	Wrench	Sketch of installation
				
ØD=0.625"	ZOHX5-□□	I70M5×12TT	WT15IP	
ØD=0.75"	ZOHX6-□□	I70M5×16TT	WT20IP	
ØD=1.00"	ZOHX8-□□	I70M6×20TT	WT20IP	
ØD=1.25"	ZOHX10-□□	I70M8×25TT	WT30IT	

Selection of inserts

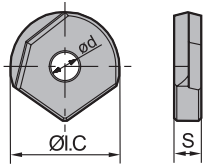

😊 Good working conditions 😐 General working conditions 😞 Adverse working conditions

Workpiece material	P Steel	M Stainless steel	K Cast iron	N Ferrite materials	S Heat-resistant steel	YBC302	YBM251	YBM253	YBG102	YBG205	YBG252	YBG302	YD101	YD201
P Steel	😊	😊	😊	😊	😊	😊	😊	😊	😊	😊	😊	😊	😊	😊
M Stainless steel	😊	😊	😊	😊	😊	😊	😊	😊	😊	😊	😊	😊	😊	😊
K Cast iron	😊	😊	😊	😊	😊	😊	😊	😊	😊	😊	😊	😊	😊	😊
N Ferrite materials	😊	😊	😊	😊	😊	😊	😊	😊	😊	😊	😊	😊	😊	😊
S Heat-resistant steel	😊	😊	😊	😊	😊	😊	😊	😊	😊	😊	😊	😊	😊	😊

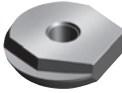
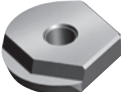
Insert shape	Type	Dimensions(inch)			Coated grade						Uncoated grade		Adaptable tool holders	
		ØI.C	ød	S	YBC302	YBM251	YBM253	YBG102	YBG205	YBG252	YBG302	YD101		YD201
	ZOHX5-GF	0.625	0.197	0.157						●				D0.625"
	ZOHX6-GF	0.750	0.197	0.197						●				D0.75"
	ZOHX8-GF	1.000	0.236	0.236						●				D1.00"
	ZOHX10-GF	1.250	0.315	0.276						●				D1.25"
	ZOHX5-GM	0.625	0.197	0.157						●				D0.625"
	ZOHX6-GM	0.750	0.197	0.197						●				D0.75"
	ZOHX8-GM	1.000	0.236	0.236						●				D1.00"
	ZOHX10-GM	1.250	0.315	0.276						●				D1.25"

● Always stock available ○ Produce according to order

Calculation of cutting speed for BMR02/04 series ball nose end mills

1. When the tool axial line is vertical to the surface being machined,

$$N = \frac{1000 V_c}{\pi D_c} \text{ (r/min)}$$

$$D_c = 2\sqrt{a_p(D - a_p)}$$

N: rotating speed
 Vc: actual cutting speed
 Dc: effective cutting diameter
 D: tool nominal diameter
 ap: axial cutting depth

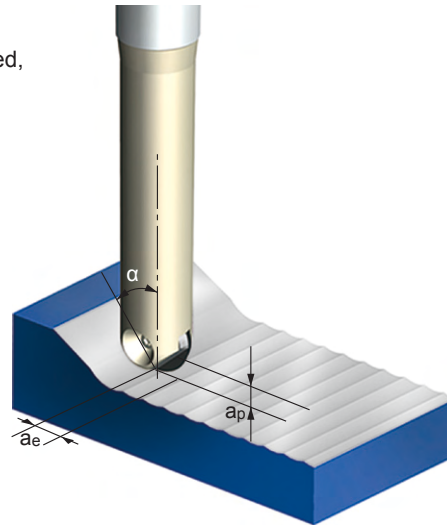

2. When there is an inclined angle between the tool axial line and the surface being machined, the recommended cutting speed should be multiplied by a factor in the table below to obtain the cutting speed used for programming.

Diameter (inch)		Ø0.625		Ø0.75		Ø1.00		Ø1.25	
Cutting depth ap(inch)		0.008	0.020	0.020	0.039	0.020	0.039	0.020	0.060
Inclined angle alpha	15°	1.00	1.00	1.00	1.02	1.00	1.01	1.00	1.00
	30°	1.05	1.01	1.02	1.04	1.03	1.04	1.04	1.00
	45°	1.18	1.10	1.12	1.06	1.14	1.08	1.16	1.06
	60°	1.47	1.30	1.34	1.21	1.38	1.25	1.43	1.22
	75°	2.14	1.73	1.83	1.53	1.93	1.62	2.04	1.55
	90°	4.48	2.87	3.20	2.29	3.57	2.55	4.03	2.37

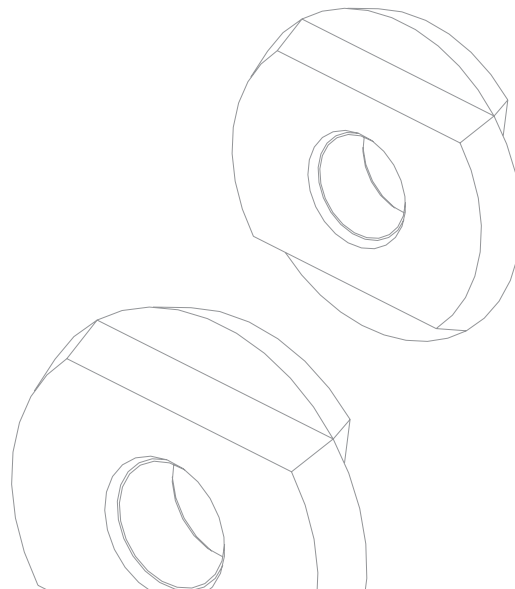
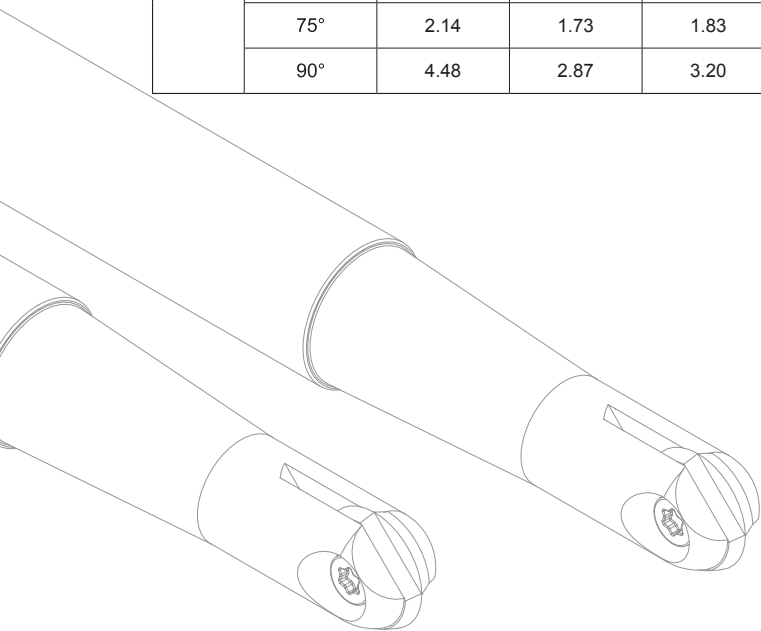

Recommended cutting parameters

Workpiece material	Hardness HB	Insert grade	Cutting parameters	Ø0.625	Ø0.75	Ø1.00	Ø1.25
P	Carbon steel	HB ≤ 180	V(SFPM)	300~650	300~650	300~650	300~650
			fz(in/z)	0.008~0.012	0.008~0.012	0.01~0.014	0.01~0.014
			a _{pmax} (inch)	0.04	0.05	0.06	0.08
			a _{emax} (inch)	0.04	0.05	0.06	0.08
	Alloy steel	HB180~280	V(SFPM)	260~600	260~600	260~600	260~600
			fz(in/z)	0.008~0.012	0.008~0.012	0.01~0.014	0.01~0.014
			a _{pmax} (inch)	0.04	0.05	0.06	0.08
			a _{emax} (inch)	0.04	0.05	0.06	0.08
	Hardened steel	HRC55~65	V(SFPM)	200~300	200~300	200~300	200~300
			fz(in/z)	0.008~0.012	0.008~0.012	0.01~0.014	0.01~0.014
			a _{pmax} (inch)	0.02	0.024	0.032	0.04
			a _{emax} (inch)	0.02	0.024	0.032	0.04
M	Stainless steel	HB ≤ 270	V(SFPM)	230~500	230~500	230~500	230~500
			fz(in/z)	0.004~0.01	0.004~0.01	0.008~0.012	0.008~0.012
			a _{pmax} (inch)	0.032	0.04	0.05	0.06
			a _{emax} (inch)	0.032	0.04	0.05	0.06
K	Cast iron	HB180-250	V(SFPM)	500~1000	500~1000	500~1000	500~1000
			fz(in/z)	0.01~0.014	0.01~0.014	0.012~0.016	0.012~0.016
			a _{pmax} (inch)	0.06	0.07	0.08	0.1
			a _{emax} (inch)	0.06	0.07	0.08	0.1



High feed milling cutters

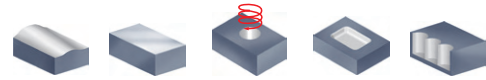

XMR01 P M K



S-type insert, straight shank

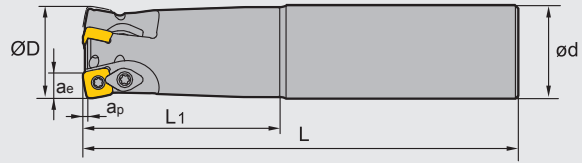

Specification of tools

Type		Dimensions(inch)						
		ØD	ød	L ₁	L	a _p max	a _e max	Z
XMR01	-0.75"-G0.75"-SD06-02	0.75	0.75	2.5	6	0.031	0.196	2
	-1.00"-G1.00"-SD06-03	1.00	1.00	3.5	7	0.031	0.196	3
	-1.00"-G1.00"-SD09-02	1.00	1.00	3.5	7	0.055	0.297	2
	-1.25"-G1.25"-SD09-03	1.25	1.25	3.5	8	0.055	0.297	3
	-1.25"-G1.25"-SD12-02	1.25	1.25	3.5	8	0.071	0.380	2
	-1.50"-G1.50"-SD12-03	1.50	1.50	3.5	8	0.071	0.380	3
	-1.75"-G1.50"-SD15-02	1.75	1.50	4.5	10	0.087	0.508	2

High feed milling cutters

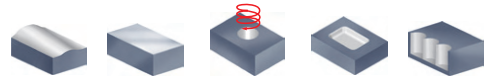

XMR01 P M K S





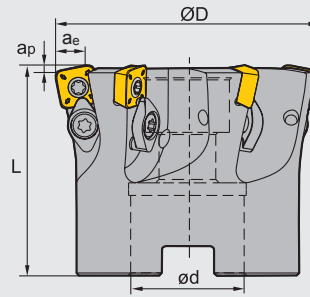

S-type insert, arbor mounting



Specification of tools

Type		Dimensions(inch)					
		ØD	ød	L	apmax	aemax	Z
XMR01	-2.00"-A0.75"-SD06-07	2.0	0.75	1.75	0.031	0.196	7
	-2.50"-A0.75"-SD06-10	2.5	0.75	1.75	0.031	0.196	10
	-2.50"-A1.00"-SD06-10	2.5	1.00	2.00	0.031	0.196	10
	-2.00"-A0.75"-SD09-05	2.0	0.75	1.75	0.055	0.297	5
	-2.50"-A0.75"-SD09-07	2.5	0.75	1.75	0.055	0.297	7
	-2.50"-A1.00"-SD09-07	2.5	1.00	2.00	0.055	0.297	7
	-2.50"-A0.75"-SD12-05	2.5	0.75	1.75	0.071	0.380	5
	-2.50"-A1.00"-SD12-05	2.5	1.00	2.00	0.071	0.380	5
	-3.00"-A1.00"-SD12-06	3.0	1.00	2.00	0.071	0.380	6
	-3.00"-A1.25"-SD12-06	3.0	1.25	2.00	0.071	0.380	6
	-4.00"-B1.50"-SD12-08	4.0	1.50	2.50	0.071	0.380	8
	-3.00"-A1.00"-SD15-05	3.0	1.00	2.00	0.087	0.508	5
	-3.00"-A1.25"-SD15-05	3.0	1.25	2.00	0.087	0.508	5
	-4.00"-B1.50"-SD15-07	4.0	1.50	2.50	0.087	0.508	7
	-5.00"-B1.50"-SD15-09	5.0	1.50	2.50	0.087	0.508	9
-6.00"-B2.00"-SD15-12	6.0	2.00	2.50	0.087	0.508	12	

Spare parts

Tool type	Insert screw	Wedge screw	Clamp	Insert wrench	Wedge wrench	Sketch of installation
						
XMR01□□-SD06□□	I60M2.2×5.5	--	--	WT07IP	---	
XMR01□□-SD09□□	I60M3.5×08TT	I60M4×8.4	WD-204	WT10IP	WT15IP	
XMR01□□-SD12□□	I60M4× 8.4	I60M4×8.4	WD-204	WT15IP	WT15IP	
XMR01□□-SD15□□	I60M5×13	I60M5×13	WD-208	WT20IP	WT20IP	

Selection of inserts

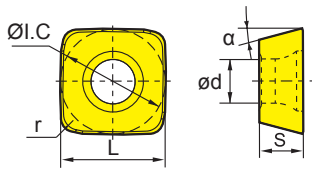

😊 Good working conditions 🙄 General working conditions 😞 Adverse working conditions

Workpiece material	Steel	Stainless steel	Cast iron	Ferrite materials	Heat-resistant steel
P	😊	😊	😊	😊	😊
M	😊	😊	😊	😊	😊
K	😊	😊	😊	😊	😊
N	😊	😊	😊	😊	😊
S	😊	😊	😊	😊	😊

Insert shape	Type	Dimensions(inch)						Coated grade						Uncoated grade				
		α	L	r	S	ød	ØI.C	YBC302	YBM251	YBM253	YBM351	YBG102	YBG202	YBG212	YBG205	YBG302	YD101	YD201
	SDMT06T208-DM	15°	0.250	0.031	0.101	0.102	0.250	●				●				○		
	SDMT09T312-DM	15°	0.375	0.047	0.156	0.157	0.375	●				●				○		
	SDMT120412-DM	15°	0.500	0.047	0.187	0.173	0.500	●				●				○		
	SDMT150520-DM	15°	0.625	0.079	0.219	0.220	0.625	●				●				○		
	SDMT06T208-PM	15°	0.250	0.031	0.101	0.102	0.250	●		○					●			
	SDMT09T312-PM	15°	0.375	0.047	0.156	0.157	0.375	●		●					●			
	SDMT120412-PM	15°	0.500	0.047	0.187	0.173	0.500	●		●					●			
	SDMT150520-PM	15°	0.625	0.079	0.219	0.220	0.625	●		●					●			
	SDMT09T312-NM	15°	0.500	0.047	0.187	0.173	0.500			●				●				
	SDMT120412-NM	15°	0.375	0.047	0.156	0.157	0.375							●				

● Always stock available ○ Produce according to order

Chipbreaker introduction:

- PM chipbreaker is more suitable for machining with power shortage and for relatively adhesive materials, such as stainless steel.
- DM chipbreaker is relatively suitable for machining of hard materials such as hardened steel, cast iron, etc.
- NM chipbreaker is more suitable for machining Ti alloy and high temp alloy.

High feed milling cutters

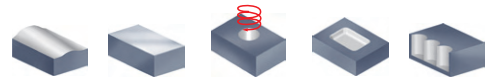

XMR01 **P** **M** **K**



W-type insert, straight shank

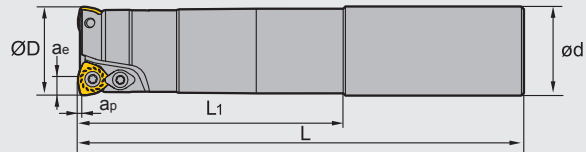

Specification of tools

Type		Dimensions(inch)						
		ØD	ap	ae	L1	L	ød	Z
XMR01	-0.75" -G0.75" -WP05-02-M	0.75	0.059	0.150	1.75	5.00	0.75	2
	-0.75" -G0.75" -WP05-02-L	0.75	0.059	0.150	3.75	7.00	0.75	2
	-0.75" -G0.75" -WP05-02-XL	0.75	0.059	0.150	4.75	10.00	0.75	2
	-1.00" -G1.00" -WP06-02-M	1.00	0.059	0.171	2.25	5.50	1.00	2
	-1.00" -G1.00" -WP06-02-L	1.00	0.059	0.171	4.75	8.00	1.00	2
	-1.00" -G1.00" -WP06-02-XL	1.00	0.059	0.171	4.75	12.00	1.00	2
	-1.25" -G1.25" -WP06-02-M	1.25	0.059	0.171	2.75	6.00	1.25	2
	-1.25" -G1.25" -WP06-02-L	1.25	0.059	0.171	4.75	8.00	1.25	2
	-1.25" -G1.25" -WP06-02-XL	1.25	0.059	0.171	7.25	12.00	1.25	2
	-1.50" -G1.25" -WP06-03-M	1.50	0.059	0.171	2.00	6.00	1.25	3
	-1.50" -G1.50" -WP06-03-L	1.50	0.059	0.171	2.00	10.00	1.50	3
	-1.50" -G1.25" -WP06-03-XL	1.50	0.059	0.171	2.00	12.00	1.25	3
	-1.50" -G1.25" -WP08-02-M	1.50	0.059	0.223	2.00	6.00	1.25	2
	-1.50" -G1.25" -WP08-02-L	1.50	0.059	0.223	2.00	10.00	1.25	2
	-1.50" -G1.25" -WP08-02-XL	1.50	0.059	0.223	2.00	12.00	1.25	2
	-2.00" -G1.50" -WP09-02-M	2.00	0.118	0.268	2.15	6.00	1.50	2
-2.00" -G1.50" -WP09-02-L	2.00	0.118	0.268	2.15	10.00	1.50	2	

Spare parts

Adaptable tool holders	Insert screw	Clamp	Wrench	Sketch of installation
XMR01 □□-WP05□□	I60M3.5×08TT		WT10P	
XMR01 □□-WP06□□	I60M4×8.4	--	WT15P	
XMR01 □□-WP08□□	I60M5×13	WD-208	WT20IT	
XMR01 □□-WP09□□				

High feed milling cutters

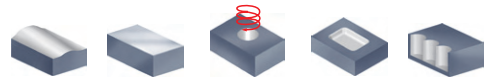

XMR01 **P** **M** **K**

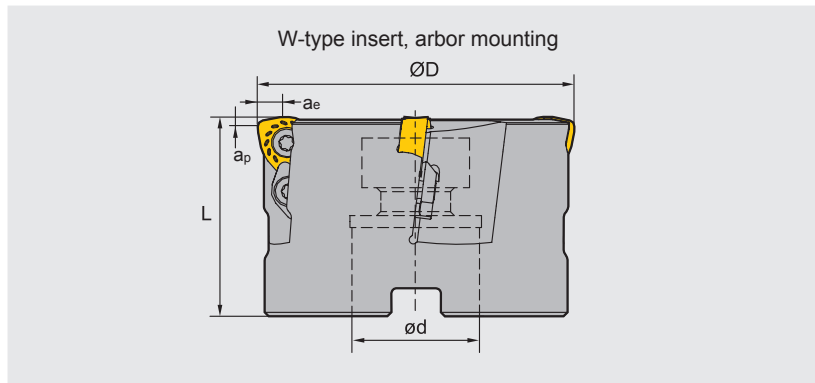

Specification of tools

Type		Dimensions(inch)					
		$\varnothing D$	a_p	a_e	L	$\varnothing d$	Z
XMR01	-2.00"-A0.75"-WP06-05	2.00	0.75	2.00	0.059	0.171	5
	-2.00"-A0.75"-WP08-04	2.00	0.75	2.00	0.059	0.223	4
	-2.00"-A0.75"-WP06-04	2.00	0.059	0.171	2.00	0.75	4
	-2.50"-A0.75"-WP08-04	2.50	0.059	0.223	2.00	0.75	4
	-2.50"-A1.00"-WP08-04	2.50	0.059	0.223	2.00	1.00	4
	-2.50"-A0.75"-WP09-03	2.50	0.118	0.268	2.00	0.75	3
	-3.00"-A1.25"-WP08-04	3.00	0.059	0.223	2.50	1.25	4
	-3.00"-A1.25"-WP09-04	3.00	0.118	0.268	2.50	1.25	4
	-4.00"-B1.25"-WP08-05	4.00	0.059	0.223	2.50	1.25	5
	-4.00"-B1.25"-WP09-05	4.00	0.118	0.268	2.50	1.25	5

Spare parts

Tool type	Insert screw	Clamp	Wrench	Sketch of installation
XMR01□□-WP06□□	I60M4×8.4	--	WT15S	
XMR01□□-WP08□□	I60M5×13	WD-208	WT20IT	
XMR01□□-WP09□□	I60M5×13	WD-208	WT20IT	

Selection of inserts

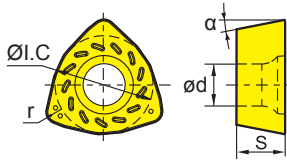

😊 Good working conditions 😐 General working conditions 😞 Adverse working conditions

Workpiece material	P Steel	M Stainless steel	K Cast iron	N Ferrite materials	S Heat-resistant steel
P Steel	😊	😊	😊	😊	😊
M Stainless steel	😊	😊	😊	😊	😊
K Cast iron	😊	😊	😊	😊	😊
N Ferrite materials	😊	😊	😊	😊	😊
S Heat-resistant steel	😊	😊	😊	😊	😊

Insert shape	Type	Dimensions(inch)					Coated grade								Uncoated grade	
		α	r	ϕd	S	$\phi I.C$	YBC302	YBM251	YBM253	YBM351	YBG102	YBG202	YBG205	YBG302	YD101	YD201
	WPGT050315ZSR	11°	0.059	0.157	0.138	0.313	●			●						
	WPGT060415ZSR	11°	0.059	0.173	0.165	0.375	●			●						
	WPGT080615ZSR	11°	0.059	0.217	0.250	0.506	●			●						
	WPGT090725ZSR	11°	0.098	0.217	0.276	0.591	●			●						
	WPGT050315ZSR-PM	11°	0.059	0.157	0.138	0.313	●			●		●				
	WPGT060415ZSR-PM	11°	0.059	0.173	0.165	0.375	●			●		●				
	WPGT080615ZSR-PM	11°	0.059	0.217	0.250	0.506	●			●		●				
	WPGT090725ZSR-PM	11°	0.098	0.217	0.276	0.591	●			●		●				

● Always stock available ○ Produce according to order

Chipbreaker introduction:

-PM chipbreaker has sharp cutting edge. It is more suitable for machining with power shortage and for relatively adhesive materials, such as stainless steel and Ti alloy. etc.
 General chipbreaker has blunt cutting edge and is relatively suitable for machining of hard materials such as hardened steel and cast iron. etc.



Recommended cutting parameters

Workpiece material	Hardness HB	Insert grade	Cutting speed (SFPM)	Ø0.75/Ø1.00		Ø1.25		
				Axial cutting depth	Feed rate per tooth	Axial cutting depth	Feed rate per tooth	
P Soft steel Carbon Steel	≤ HB180 HB180-280	YBG202	550(400-700)	0.024~0.04	0.032~0.048	0.032~0.048	0.04~0.056	
		YBM253 YBM351 YBC302	500(300-650)					
	Alloy steel Alloy tool steel	HB280-350 ≤ HB350	YBG202	450(300-650)	0.016~0.032	0.032~0.048	0.024~0.04	0.04~0.056
			YBM253 YBM351 YBC302	400(260-600)				
			YBG202	450(300-600)				
	pre-hardened steel	≤ HRC35	YBM253 YBM351 YBC302	400(260-500)	0.016~0.032	0.024~0.04	0.024~0.04	0.032~0.048
YBG202			450(300-600)					
YBM253 YBM351			400(260-500)					
M Stainless steel	≤ HB270	YBM253 YBM351	400(260-500)	0.024~0.04	0.024~0.04	0.032~0.048	0.032~0.048	
		YBG202 YBG205	400(260-600)					
K Common cast Iron	Tensile strength ≤ 350MPa	YBG202	500(350-700)	0.024~0.04	0.04~0.056	0.032~0.048	0.048~0.064	
		YBG302	500(300-650)					
Nodular cast iron	Tensile strength ≤ 800MPa	YBG202	400(300-600)	0.016~0.032	0.032~0.048	0.024~0.04	0.04~0.056	
		YBG302	400(260-500)					
S High-temperature alloy	≤ 400	YBG212	150(60-200)	0.016~0.031	0.004-0.010	0.02-0.035	0.005-0.012	

Recommended cutting parameters

Workpiece material	Hardness HB	Insert grade	Cutting speed (SFPM)	Ø1.50		Ø2.00/2.50		Ø3.00/4.00/5.00/6.00		
				Axial cutting depth	Feed rate per tooth	Axial cutting depth	Feed rate per tooth	Axial cutting depth	Feed rate per tooth	
P Soft steel Carbon steel	≤ HB180 HB180-280	YBG202	550(400-700)	0.032~0.048	0.04~0.056	0.043~0.06	0.043~0.06	0.04~0.06	0.04~0.06	
		YBM253 YBM351 YBC302	500(300-650)							
	Alloy steel Alloy tool steel	HB280-350 ≤ HB350	YBG202	450(300-650)	0.024~0.04	0.04~0.056	0.035~0.051	0.43~0.06	0.032~0.051	0.04~0.06
			YBM253 YBM351 YBC302	400(260-600)						
			YBG202	450(300-600)						
	Pre-hardened steel	≤ HRC35	YBM253 YBM351 YBC302	400(260-500)	0.024~0.04	0.032~0.048	0.035~0.051	0.035~0.051	0.032~0.051	0.032~0.051
YBG202			450(300-600)							
YBM253 YBM351			400(260-500)							
M Stainless steel	≤ HB270	YBM253 YBM351	400(260-500)	0.032~0.048	0.032~0.048	0.043~0.06	0.035~0.051	0.04~0.06	0.032~0.051	
		YBG202 YBG205	400(260-600)							
K Common cast iron	Tensile strength ≤ 350MPa	YBG202	500(350-700)	0.032~0.048	0.048~0.064	0.043~0.06	0.051~0.067	0.04~0.06	0.048~0.067	
		YBG302	500(300-650)							
Nodular cast iron	Tensile strength ≤ 800MPa	YBG202	400(300-600)	0.024~0.04	0.04~0.056	0.035~0.051	0.043~0.06	0.032~0.051	0.04~0.06	
		YBG302	400(260-500)							
S High-temperature alloy	≤ 400	YBG212	150(60-200)	0.02-0.035	0.005-0.016	0.03-0.047	0.006-0.016	0.03-0.05	0.005-0.02	

Chamfer milling tools **Kr:45°**



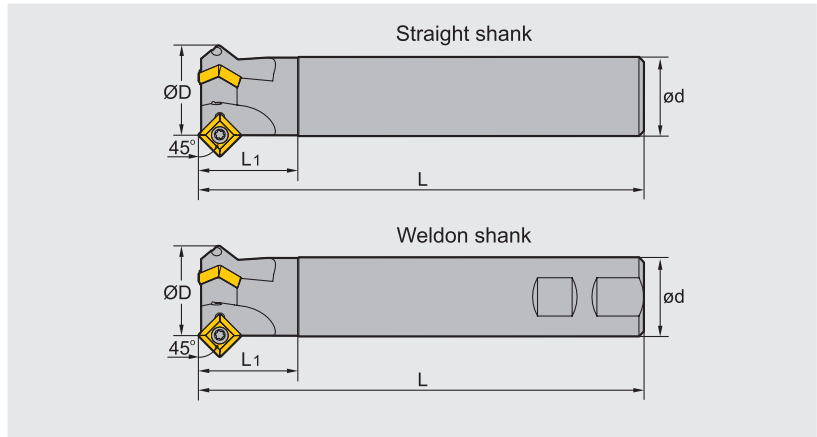

CMA01 **P** **M** **K**



Specification of tools

Type		Dimensions(inch)				
		ØD	ød	L	L ₁	Z
CMA01 Cylindrical	-0.50"-G0.75"-SP12-01	0.50	0.75	4.00	1.50	1
	-1.00"-G1.00"-SP12-02	1.00	1.00	5.00	1.50	2
	-1.25"-G1.25"-SP12-03	1.25	1.25	7.00	1.50	3
Weldon	-0.50"-XP0.75"-SP12-01	0.50	0.75	4.00	1.50	1
	-1.00"-XP1.00"-SP12-02	1.00	1.00	5.00	1.50	2
	-1.25"-XP1.25"-SP12-03	1.25	1.25	7.00	1.50	3

Spare parts

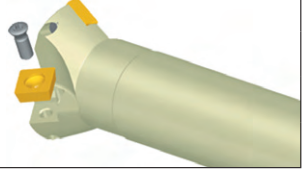
Diameter ØD	Screw	Wrench	Sketch of installation
0.50"~1.25"	 I43M5×11	 WT20IS	

Chamfer milling tools **Kr:60°**



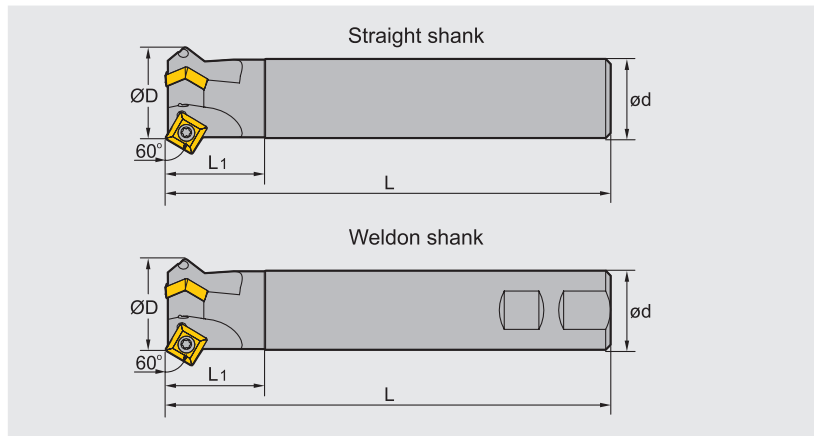

CMD01 **P** **M** **K**



Specification of tools

Type		Dimensions(inch)				
		ØD	ød	L	L1	Z
CMD01 Straight shank	-0.50" -G0.75" -SP12-01	0.50	0.75	4.00	1.50	1
	-1.00" -G1.00" -SP12-02	1.00	1.00	5.00	1.50	2
	-1.25" -G1.25" -SP12-03	1.25	1.25	7.00	1.50	3
Weldon shank	-0.50" -XP0.75" -SP12-01	0.50	0.75	4.00	1.50	1
	-1.00" -XP1.00" -SP12-02	1.00	1.00	3.00	1.50	2
	-1.25" -XP1.25" -SP12-03	1.25	1.25	7.00	1.50	3

Spare parts

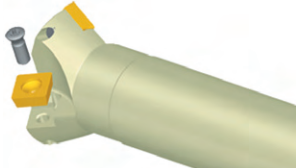
Diameter ØD	Screw	Wrench	Sketch of installation
0.50"~1.25"	 I43M5×11	 WT20IS	

Selection of inserts

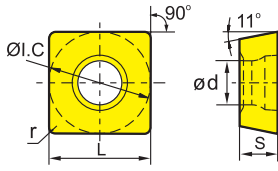

😊 Good working conditions 😊 General working conditions 😞 Adverse working conditions

Workpiece material	P Steel	M Stainless steel	K Cast iron	N Ferrite materials	S Heat-resistant steel								
P Steel	😊	😊	😊	😊	😊	😊	😊	😊	😊	😊	😊	😊	😊
M Stainless steel	😊	😊	😊	😊	😊	😊	😊	😊	😊	😊	😊	😊	😊
K Cast iron													😞
N Ferrite materials													😞
S Heat-resistant steel										😞			

Insert shape	Type	Dimensions(inch)					Coated grade					Uncoated grade		
		ØI.C	L	r	s	ød	YBC302	YBM251	YBM253	YBM351	YBG205	YBG302	YC30S	YD201
	SPMT120408	0.500	0.500	0.31	0.337	0.217		●		●		●	○	

● Always stock available ○ Produce according to order

Recommended cutting parameters

Workpiece material	Hardness HB	Insert grade	Cutting parameters		
			Cutting speed(SFPM)	Feed speed (in/z)	
P	Low-carbon steel, Soft steel	YBM251	600(300-800)	0.01(0.004~0.016)	
		YBM351 YBG302	500(300-650)	0.012(0.004~0.02)	
		YC30S	400(260-500)	0.016(0.004~0.02)	
	High-carbon steel, Alloy steel	YBM251	500(300-700)	0.012(0.004~0.016)	
		YBM351 YBG302	400(300-600)	0.012(0.004~0.02)	
		YC30S	300(200-500)	0.016(0.004~0.02)	
	Alloy tool steel	YBM251	400(260-600)	0.012(0.004~0.016)	
		YBM351 YBG302	300(260-500)	0.012(0.004~0.02)	
		YC30S	260(200-400)	0.016(0.004~0.02)	
M	Stainless steel	YBM251	400(260-600)	0.012(0.004~0.016)	
		YBM351 YBG302	300(260-500)	0.012(0.004~0.02)	
		YC30S	260(200-400)	0.016(0.004~0.02)	
K	Cast iron	180-250	YBG302	400(300-600)	0.016(0.004~0.02)



Common problems and solutions for milling

Main points of solution and inspection		Selection of tool material		Cutting condition					Tool shape							Machine clamping system			
		Material with higher hardness	Material with perfect roughness	Cutting speed	Feed rate	Cutting depth	Change the diameter and width of milling tools	Cutting liquid	Rake angle	Approach angle	Strength of cutting edge	Number of teeth	Increase the width of chip pocket	Examine the geometry shape of Minor cutting edge.	check the end face run-out	Improve the rigidity of tool	Clamping system of workpiece	Overhang of tool	Power, gap
Failure																			
Fracture of tool nose	Severe abrasion on clearance face	Improper cutting condition			↓			✓											
		Unsuitable geometry shape of cutting edge	✓						↑		↓								
	Severe abrasion on rake face	Improper cutting condition			↓	↓	↓	✓											
		Unsuitable geometry shape of cutting edge	✓						↑	↓	↓								
	Fracture of cutting edge	Improper cutting condition				↓	↓												
		Unsuitable geometry shape of cutting edge		✓							↓	↑		✓	✓	✓	✓	✓	✓
	Thermal cracking	Improper cutting condition			↓	↓	↓		✓										
		Unsuitable geometry shape of cutting edge								↑		↓							
Build-up edge	Improper cutting condition			↑	↑			✓											
	Unsuitable geometry shape of cutting edge								↑		↓								
Machining precision	Bad surface roughness	Abrasion of tool Great vibration of milling tool	✓		↑	↓	↓		✓		↓		Wiper	✓					
		Unsuitable geometry shape of cutting edge			↓	↓	↓	✓											
	Burrs occurring	Improper geometry shape of cutting edge								↑	↑	↓		✓					
		Unsuitable geometry shape of cutting edge				↓	↓												
	Side collapse	Unsuitable geometry shape of cutting edge				↓	↓			↑	↓	↓	↑	✓		✓			
		Unsuitable geometry shape of cutting edge								↑	↓	↓	↑	✓		✓			
Planeness and parallelism deterioration	Improper geometry Improper technique				↓	↓			↑	↑		↓	✓	✓	✓	✓	✓		
Other	Great vibration	Cutting condition Improper technology			↓	↓	↓	✓		↑	↑	↓			✓	✓	✓	✓	
	Chips twisting and jamming	Improper cutting condition			↑	↑↓		✓	✓			↓							
		Unsuitable geometry shape of cutting edge								↑		↓	✓						

*New product for
milling*

HMX

*High hardness
machining series*



Milling Tools







GM series

Cutting tools

SOLID CARBIDE CUTTING TOOLS

Overview of end mills	P290-291
Code key of end mills	P292
GM series end mills	P293-299
HMX series end mills	P300-303
AL series end mills	P304-305
UM series end mills	P306-308
VSM series end mills	P309-312
Cutting parameters of GM series end mills	P313-319
Cutting parameters of HMX series end mills	P320-323
Cutting parameters of AL series end mills	P324-326
Cutting parameters of UM series end mills	P327
Cutting parameters of VSM series end mills	P328-329

Product overview of solid carbide end mills

● GM for universal machining



● HMX for high-hardness material machining

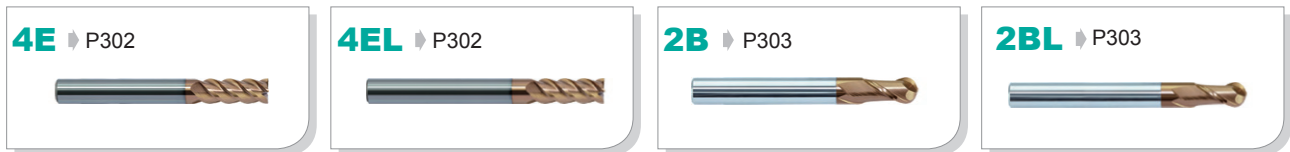

● AL For aluminium alloy machining

2E ▶ P304



3E ▶ P304



2B ▶ P305



2R-AIR ▶ P305



● UM High performance universal milling

4E ▶ P308



4EL ▶ P308



● VSM for hard-to-cut materials milling

4E ▶ P310



4EFP ▶ P311



4RFP ▶ P312



Code key of end mills

Series of tools

- GM** > Universal machining
- HMX** > High-hardness materials machining
- AL** > For aluminium alloy machining
- UM** > High performance universal milling
- VSM** > Hard-to-cut materials machining

Number of teeth

Type of tools

- E** > Flattened end mill
- B** > Ball nose end mill
- R** > R end mill

GM - 2 E L - 1/4" R015

Radius

Diameter of tools

Series of lengths

- L** > Long series
- S** > Tiny diameter
- F** > Short cutting edge
- Default** > series of standard length

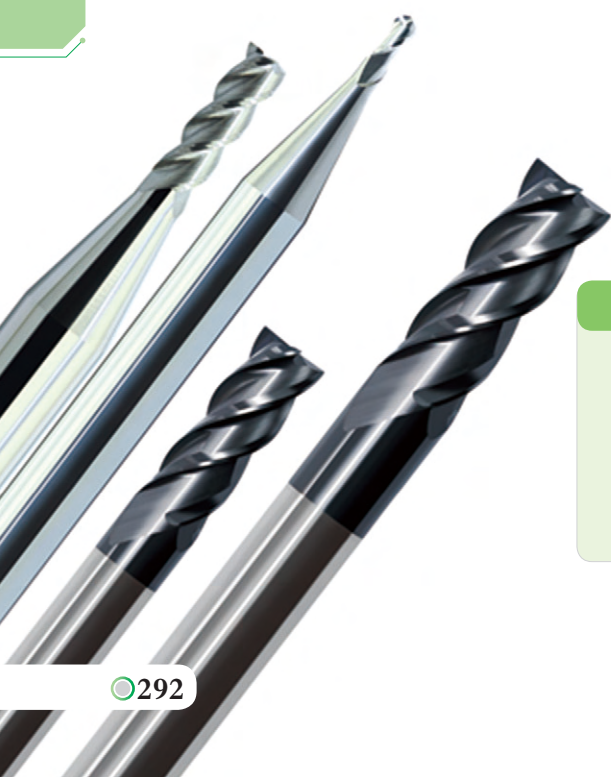
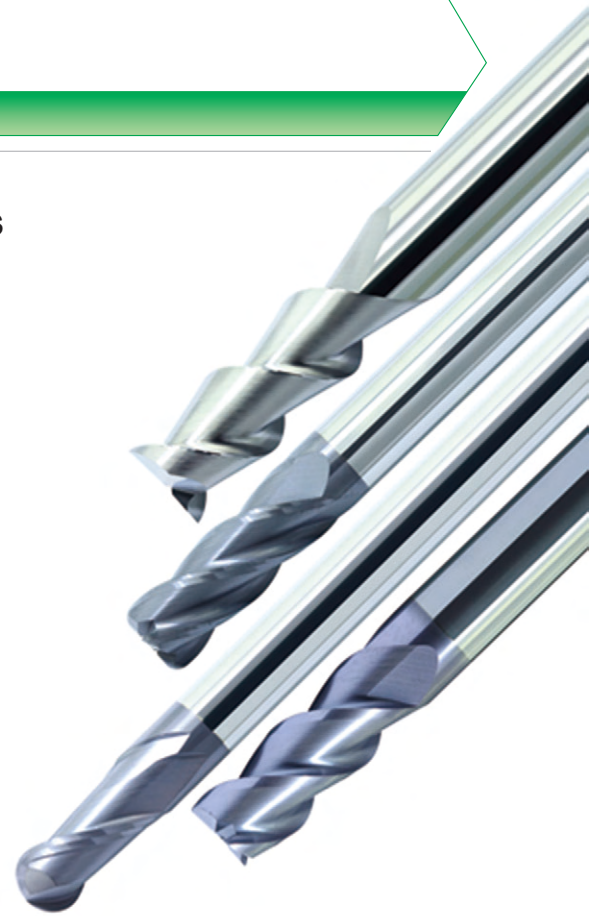

2-flute flattened end mills with straight shank

GM-2E

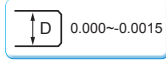
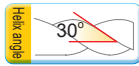
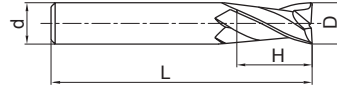

Art.No.	Specification				
	D	d	H	L	Z
GM-2E-1/32"	1/32"	1/8"	5/64"	1-1/2"	2
GM-2E-3/64"	3/64"	1/8"	7/64"	1-1/2"	2
GM-2E-1/16"	1/16"	1/8"	3/16"	1-1/2"	2
GM-2E-5/64"	5/64"	1/8"	3/16"	1-1/2"	2
GM-2E-3/32"	3/32"	1/8"	9/32"	1-1/2"	2
GM-2E-7/64"	7/64"	1/8"	3/8"	1-1/2"	2
GM-2E-1/8"	1/8"	1/8"	1/2"	1-1/2"	2
GM-2E-9/64"	9/64"	3/16"	1/2"	2"	2
GM-2E-5/32"	5/32"	3/16"	1/2"	2"	2
GM-2E-11/64"	11/64"	3/16"	5/8"	2"	2
GM-2E-3/16"	3/16"	3/16"	5/8"	2"	2
GM-2E-13/64"	13/64"	1/4"	5/8"	2-1/2"	2
GM-2E-7/32"	7/32"	1/4"	5/8"	2-1/2"	2
GM-2E-15/64"	15/64"	1/4"	3/4"	2-1/2"	2
GM-2E-1/4"	1/4"	1/4"	3/4"	2-1/2"	2
GM-2E-17/64"	17/64"	5/16"	3/4"	2-1/2"	2
GM-2E-9/32"	9/32"	5/16"	3/4"	2-1/2"	2
GM-2E-19/64"	19/64"	5/16"	13/16"	2-1/2"	2
GM-2E-5/16"	5/16"	5/16"	13/16"	2-1/2"	2

Art.No.	Specification				
	D	d	H	L	Z
GM-2E-21/64"	21/64"	3/8"	1"	2-1/2"	2
GM-2E-11/32"	11/32"	3/8"	1"	2-1/2"	2
GM-2E-23/64"	23/64"	3/8"	1"	2-1/2"	2
GM-2E-3/8"	3/8"	3/8"	1"	2-1/2"	2
GM-2E-25/64"	25/64"	7/16"	1"	2-3/4"	2
GM-2E-13/32"	13/32"	7/16"	1"	2-3/4"	2
GM-2E-27/64"	27/64"	7/16"	1"	2-3/4"	2
GM-2E-7/16"	7/16"	7/16"	1"	2-3/4"	2
GM-2E-29/64"	29/64"	1/2"	1"	3"	2
GM-2E-15/32"	15/32"	1/2"	1"	3"	2
GM-2E-31/64"	31/64"	1/2"	1"	3"	2
GM-2E-1/2"	1/2"	1/2"	1"	3"	2
GM-2E-9/16"	9/16"	9/16"	1-1/8"	3-1/2"	2
GM-2E-5/8"	5/8"	5/8"	1-1/4"	3-1/2"	2
GM-2E-11/16"	11/16"	3/4"	1-3/8"	4"	2
GM-2E-3/4"	3/4"	3/4"	1-1/2"	4"	2
GM-2E-7/8"	7/8"	7/8"	1-1/2"	4"	2
GM-2E-1"	1"	1"	1-1/2"	4"	2



2-flute flattened long cutting edge end mills with straight shank

GM-2EL

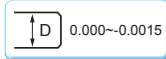
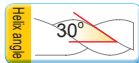
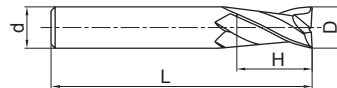

Art.No.	Specification				
	D	d	H	L	Z
GM-2EL-1/8"	1/8"	1/8"	3/4"	2-1/4"	2
GM-2EL-3/16"	3/16"	3/16"	3/4"	2-1/2"	2
GM-2EL-1/4"	1/4"	1/4"	1-1/8"	3"	2
GM-2EL-5/16"	5/16"	5/16"	1-1/8"	3"	2
GM-2EL-3/8"	3/8"	3/8"	1-1/8"	3"	2

Art.No.	Specification				
	D	d	H	L	Z
GM-2EL-7/16"	7/16"	7/16"	2"	4-1/2"	2
GM-2EL-1/2"	1/2"	1/2"	2"	4-1/2"	2
GM-2EL-5/8"	5/8"	5/8"	2-1/4"	5"	2
GM-2EL-3/4"	3/4"	3/4"	2-1/4"	5"	2
GM-2EL-1"	1"	1"	2-1/4"	5"	2

3-flute flattened end mills with straight shank

GM-3E

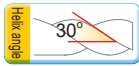
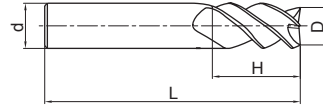

Art.No.	Specification				
	D	d	H	L	Z
GM-3E-3/64"	3/64"	1/8"	7/64"	1-1/2"	3
GM-3E-1/16"	1/16"	1/8"	3/16"	1-1/2"	3
GM-3E-5/64"	5/64"	1/8"	3/16"	1-1/2"	3
GM-3E-3/32"	3/32"	1/8"	9/32"	1-1/2"	3
GM-3E-7/64"	7/64"	1/8"	3/8"	1-1/2"	3
GM-3E-1/8"	1/8"	1/8"	1/2"	1-1/2"	3
GM-3E-9/64"	9/64"	3/16"	1/2"	2"	3
GM-3E-5/32"	5/32"	3/16"	1/2"	2"	3
GM-3E-11/64"	11/64"	3/16"	5/8"	2"	3
GM-3E-3/16"	3/16"	3/16"	5/8"	2"	3
GM-3E-13/64"	13/64"	1/4"	5/8"	2-1/2"	3
GM-3E-7/32"	7/32"	1/4"	5/8"	2-1/2"	3
GM-3E-15/64"	15/64"	1/4"	3/4"	2-1/2"	3
GM-3E-1/4"	1/4"	1/4"	3/4"	2-1/2"	3
GM-3E-17/64"	17/64"	5/16"	3/4"	2-1/2"	3
GM-3E-9/32"	9/32"	5/16"	3/4"	2-1/2"	3
GM-3E-19/64"	19/64"	5/16"	13/16"	2-1/2"	3
GM-3E-5/16"	5/16"	5/16"	13/16"	2-1/2"	3

Art.No.	Specification				
	D	d	H	L	Z
GM-3E-21/64"	21/64"	3/8"	1"	2-1/2"	3
GM-3E-11/32"	11/32"	3/8"	1"	2-1/2"	3
GM-3E-23/64"	23/64"	3/8"	1"	2-1/2"	3
GM-3E-3/8"	3/8"	3/8"	1"	2-1/2"	3
GM-3E-25/64"	25/64"	7/16"	1"	2-3/4"	3
GM-3E-13/32"	13/32"	7/16"	1"	2-3/4"	3
GM-3E-27/64"	27/64"	7/16"	1"	2-3/4"	3
GM-3E-7/16"	7/16"	7/16"	1"	2-3/4"	3
GM-3E-29/64"	29/64"	1/2"	1"	3"	3
GM-3E-15/32"	15/32"	1/2"	1"	3"	3
GM-3E-31/64"	31/64"	1/2"	1"	3"	3
GM-3E-1/2"	1/2"	1/2"	1"	3"	3
GM-3E-9/16"	9/16"	9/16"	1-1/8"	3-1/2"	3
GM-3E-5/8"	5/8"	5/8"	1-1/4"	3-1/2"	3
GM-3E-11/16"	11/16"	3/4"	1-3/8"	4"	3
GM-3E-3/4"	3/4"	3/4"	1-1/2"	4"	3
GM-3E-7/8"	7/8"	7/8"	1-1/2"	4"	3
GM-3E-1"	1"	1"	1-1/2"	4"	3

3-flute flattened long cutting edge end mills with straight shank

GM-3EL

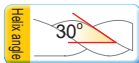
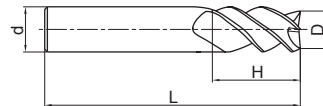

Art.No.	Specification				
	D	d	H	L	Z
GM-3EL-1/8"	1/8"	1/8"	3/4"	2-1/4"	3
GM-3EL-3/16"	3/16"	3/16"	3/4"	2-1/2"	3
GM-3EL-1/4"	1/4"	1/4"	1-1/8"	3"	3
GM-3EL-5/16"	5/16"	5/16"	1-1/8"	3"	3
GM-3EL-3/8"	3/8"	3/8"	1-1/8"	3"	3

Art.No.	Specification				
	D	d	H	L	Z
GM-3EL-7/16"	7/16"	7/16"	2"	4-1/2"	3
GM-3EL-1/2"	1/2"	1/2"	2"	4-1/2"	3
GM-3EL-5/8"	5/8"	5/8"	2-1/4"	5"	3
GM-3EL-3/4"	3/4"	3/4"	2-1/4"	5"	3
GM-3EL-1"	1"	1"	2-1/4"	5"	3

4-flute flattened end mills with straight shank

GM-4E

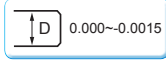
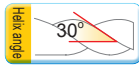
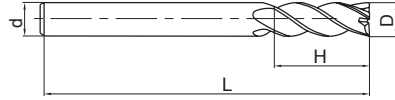

Art.No.	Specification				
	D	d	H	L	Z
GM-4E-3/64"	3/64"	1/8"	7/64"	1-1/2"	4
GM-4E-1/16"	1/16"	1/8"	3/16"	1-1/2"	4
GM-4E-5/64"	5/64"	1/8"	3/16"	1-1/2"	4
GM-4E-3/32"	3/32"	1/8"	9/32"	1-1/2"	4
GM-4E-7/64"	7/64"	1/8"	3/8"	1-1/2"	4
GM-4E-1/8"	1/8"	1/8"	1/2"	1-1/2"	4
GM-4E-9/64"	9/64"	3/16"	1/2"	2"	4
GM-4E-5/32"	5/32"	3/16"	1/2"	2"	4
GM-4E-11/64"	11/64"	3/16"	5/8"	2"	4
GM-4E-3/16"	3/16"	3/16"	5/8"	2"	4
GM-4E-13/64"	13/64"	1/4"	5/8"	2-1/2"	4
GM-4E-7/32"	7/32"	1/4"	5/8"	2-1/2"	4
GM-4E-15/64"	15/64"	1/4"	3/4"	2-1/2"	4
GM-4E-1/4"	1/4"	1/4"	3/4"	2-1/2"	4
GM-4E-17/64"	17/64"	5/16"	3/4"	2-1/2"	4
GM-4E-9/32"	9/32"	5/16"	3/4"	2-1/2"	4
GM-4E-19/64"	19/64"	5/16"	13/16"	2-1/2"	4
GM-4E-5/16"	5/16"	5/16"	13/16"	2-1/2"	4

Art.No.	Specification				
	D	d	H	L	Z
GM-4E-21/64"	21/64"	3/8"	1"	2-1/2"	4
GM-4E-11/32"	11/32"	3/8"	1"	2-1/2"	4
GM-4E-23/64"	23/64"	3/8"	1"	2-1/2"	4
GM-4E-3/8"	3/8"	3/8"	1"	2-1/2"	4
GM-4E-25/64"	25/64"	7/16"	1"	2-3/4"	4
GM-4E-13/32"	13/32"	7/16"	1"	2-3/4"	4
GM-4E-27/64"	27/64"	7/16"	1"	2-3/4"	4
GM-4E-7/16"	7/16"	7/16"	1"	2-3/4"	4
GM-4E-29/64"	29/64"	1/2"	1"	3"	4
GM-4E-15/32"	15/32"	1/2"	1"	3"	4
GM-4E-31/64"	31/64"	1/2"	1"	3"	4
GM-4E-1/2"	1/2"	1/2"	1-1/8"	3"	4
GM-4E-9/16"	9/16"	9/16"	1-1/8"	3-1/2"	4
GM-4E-5/8"	5/8"	5/8"	1-1/4"	3-1/2"	4
GM-4E-11/16"	11/16"	3/4"	1-3/8"	4"	4
GM-4E-3/4"	3/4"	3/4"	1-5/8"	4"	4
GM-4E-7/8"	7/8"	7/8"	1-5/8"	4"	4
GM-4E-1"	1"	1"	1-5/8"	4"	4

E

4-flute flattened long cutting edge end mills with straight shank

GM-4EL

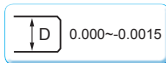
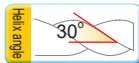

Art.No.	Specification				
	D	d	H	L	Z
GM-4EL-1/8"	1/8"	1/8"	3/4"	2-1/4"	4
GM-4EL-3/16"	3/16"	3/16"	3/4"	2-1/2"	4
GM-4EL-1/4"	1/4"	1/4"	1-1/2"	3"	4
GM-4EL-5/16"	5/16"	5/16"	1-1/2"	3"	4
GM-4EL-3/8"	3/8"	3/8"	1-1/2"	3"	4

Art.No.	Specification				
	D	d	H	L	Z
GM-4EL-7/16"	7/16"	7/16"	2-1/8"	4-1/2"	4
GM-4EL-1/2"	1/2"	1/2"	2-1/8"	4-1/2"	4
GM-4EL-5/8"	5/8"	5/8"	2-1/2"	5"	4
GM-4EL-3/4"	3/4"	3/4"	2-1/2"	5"	4
GM-4EL-1"	1"	1"	2-1/2"	5"	4

2-flute ball nose end mills with straight shank

GM-2B

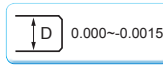
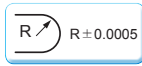
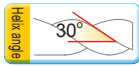
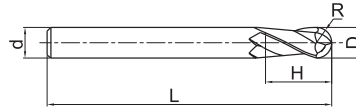

Art.No.	Specification				
	D	d	H	L	Z
GM-2B-1/32"	1/32"	1/8"	5/64"	1-1/2"	2
GM-2B-3/64"	3/64"	1/8"	7/64"	1-1/2"	2
GM-2B-1/16"	1/16"	1/8"	3/16"	1-1/2"	2
GM-2B-5/64"	5/64"	1/8"	3/16"	1-1/2"	2
GM-2B-3/32"	3/32"	1/8"	9/32"	1-1/2"	2
GM-2B-7/64"	7/64"	1/8"	3/8"	1-1/2"	2
GM-2B-1/8"	1/8"	1/8"	1/2"	1-1/2"	2
GM-2B-9/64"	9/64"	3/16"	1/2"	2"	2
GM-2B-5/32"	5/32"	3/16"	1/2"	2"	2
GM-2B-11/64"	11/64"	3/16"	5/8"	2"	2
GM-2B-3/16"	3/16"	3/16"	5/8"	2"	2
GM-2B-13/64"	13/64"	1/4"	5/8"	2-1/2"	2
GM-2B-7/32"	7/32"	1/4"	5/8"	2-1/2"	2
GM-2B-15/64"	15/64"	1/4"	3/4"	2-1/2"	2
GM-2B-1/4"	1/4"	1/4"	3/4"	2-1/2"	2
GM-2B-17/64"	17/64"	5/16"	3/4"	2-1/2"	2
GM-2B-9/32"	9/32"	5/16"	3/4"	2-1/2"	2
GM-2B-19/64"	19/64"	5/16"	13/16"	2-1/2"	2
GM-2B-5/16"	5/16"	5/16"	13/16"	2-1/2"	2

Art.No.	Specification				
	D	d	H	L	Z
GM-2B-21/64"	21/64"	3/8"	1"	2-1/2"	2
GM-2B-11/32"	11/32"	3/8"	1"	2-1/2"	2
GM-2B-23/64"	23/64"	3/8"	1"	2-1/2"	2
GM-2B-3/8"	3/8"	3/8"	1"	2-1/2"	2
GM-2B-25/64"	25/64"	7/16"	1"	2-3/4"	2
GM-2B-13/32"	13/32"	7/16"	1"	2-3/4"	2
GM-2B-27/64"	27/64"	7/16"	1"	2-3/4"	2
GM-2B-7/16"	7/16"	7/16"	1"	2-3/4"	2
GM-2B-29/64"	29/64"	1/2"	1"	3"	2
GM-2B-15/32"	15/32"	1/2"	1"	3"	2
GM-2B-31/64"	31/64"	1/2"	1"	3"	2
GM-2B-1/2"	1/2"	1/2"	1"	3"	2
GM-2B-9/16"	9/16"	9/16"	1-1/8"	3-1/2"	2
GM-2B-5/8"	5/8"	5/8"	1-1/4"	3-1/2"	2
GM-2B-11/16"	11/16"	3/4"	1-3/8"	4"	2
GM-2B-3/4"	3/4"	3/4"	1-1/2"	4"	2
GM-2B-7/8"	7/8"	7/8"	1-1/2"	4"	2
GM-2B-1"	1"	1"	1-1/2"	4"	2

2-flute ball nose end mills with long straight shank

GM-2BL

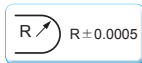
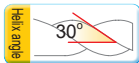
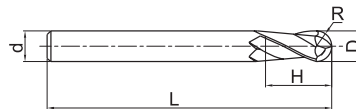

Art.No.	Specification				
	D	d	H	L	Z
GM-2BL-1/8"	1/8"	1/8"	3/4"	2-1/4"	2
GM-2BL-3/16"	3/16"	3/16"	3/4"	2-1/2"	2
GM-2BL-1/4"	1/4"	1/4"	1-1/8"	3"	2
GM-2BL-5/16"	5/16"	5/16"	1-1/8"	3"	2
GM-2BL-3/8"	3/8"	3/8"	1-1/8"	3"	2

Art.No.	Specification				
	D	d	H	L	Z
GM-2BL-7/16"	7/16"	7/16"	2"	4-1/2"	2
GM-2BL-1/2"	1/2"	1/2"	2"	4-1/2"	2
GM-2BL-5/8"	5/8"	5/8"	2-1/4"	5"	2
GM-2BL-3/4"	3/4"	3/4"	2-1/4"	5"	2
GM-2BL-1"	1"	1"	2-1/4"	5"	2

4-flute ball nose end mills with straight shank

GM-4B

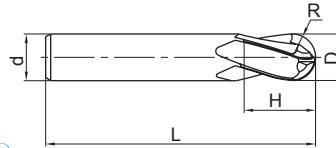

Art.No.	Specification				
	D	d	H	L	Z
GM-4B-1/8"	1/8"	1/8"	1/2"	1-1/2"	4
GM-4B-9/64"	9/64"	3/16"	1/2"	2"	4
GM-4B-5/32"	5/32"	3/16"	1/2"	2"	4
GM4B-11/64"	11/64"	3/16"	5/8"	2"	4
GM-4B-3/16"	3/16"	3/16"	5/8"	2"	4
GM-4B-13/64"	13/64"	1/4"	5/8"	2-1/2"	4
GM-4B-7/32"	7/32"	1/4"	5/8"	2-1/2"	4
GM-4B-15/64"	15/64"	1/4"	3/4"	2-1/2"	4
GM-4B-1/4"	1/4"	1/4"	3/4"	2-1/2"	4
GM-4B-17/64"	17/64"	5/16"	3/4"	2-1/2"	4
GM-4B-9/32"	9/32"	5/16"	3/4"	2-1/2"	4
GM4B-19/64"	19/64"	5/16"	13/16"	2-1/2"	4
GM-4B-5/16"	5/16"	5/16"	13/16"	2-1/2"	4
GM-4B-21/64"	21/64"	3/8"	1"	2-1/2"	4
GM-4B-11/32"	11/32"	3/8"	1"	2-1/2"	4
GM-4B-23/64"	23/64"	3/8"	1"	2-1/2"	4

Art.No.	Specification				
	D	d	H	L	Z
GM-4B-3/8"	3/8"	3/8"	1"	2-1/2"	4
GM-4B-25/64"	25/64"	7/16"	1"	2-3/4"	4
GM-4B-13/32"	13/32"	7/16"	1"	2-3/4"	4
GM-4B-27/64"	27/64"	7/16"	1"	2-3/4"	4
GM-4B-7/16"	7/16"	7/16"	1"	2-3/4"	4
GM-4B-29/64"	29/64"	1/2"	1"	3"	4
GM-4B-15/32"	15/32"	1/2"	1"	3"	4
GM-4B-31/64"	31/64"	1/2"	1"	3"	4
GM-4B-1/2"	1/2"	1/2"	1"	3"	4
GM-4B-9/16"	9/16"	9/16"	1-1/8"	3-1/2"	4
GM-4B-5/8"	5/8"	5/8"	1-1/4"	3-1/2"	4
GM-4B-11/16"	11/16"	3/4"	1-3/8"	4"	4
GM-4B-3/4"	3/4"	3/4"	1-1/2"	4"	4
GM-4B-7/8"	7/8"	7/8"	1-1/2"	4"	4
GM-4B-1"	1"	1"	1-1/2"	4"	4

4-flute ball nose end mills with long straight shank

GM-4BL

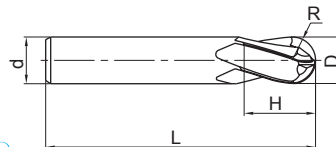

Art.No.	Specification				
	D	d	H	L	Z
GM-4BL-1/8"	1/8"	1/8"	3/4"	2-1/4"	4
GM-4BL-3/16"	3/16"	3/16"	3/4"	2-1/2"	4
GM-4BL-1/4"	1/4"	1/4"	1-1/8"	3"	4
GM-4BL-5/16"	5/16"	5/16"	1-1/8"	3"	4
GM-4BL-3/8"	3/8"	3/8"	1-1/8"	3"	4

Art.No.	Specification				
	D	d	H	L	Z
GM-4BL-7/16"	7/16"	7/16"	2"	4-1/2"	4
GM-4BL-1/2"	1/2"	1/2"	2"	4-1/2"	4
GM-4BL-5/8"	5/8"	5/8"	2-1/4"	5"	4
GM-4BL-3/4"	3/4"	3/4"	2-1/4"	5"	4
GM-4BL-1"	1"	1"	2-1/4"	5"	4

2-flute flattened end mills with straight shank and tiny diameter

GM-2ES

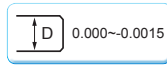
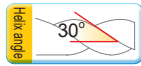
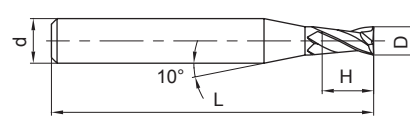

Art.No.	Specification				
	D	d	H	L	Z
GM-2ES-0.012"	0.012"	1/8"	0.018"	1-1/2"	2
GM-2ES-0.013"	0.013"	1/8"	0.020"	1-1/2"	2
GM-2ES-0.014"	0.014"	1/8"	0.021"	1-1/2"	2
GM-2ES-0.015"	0.015"	1/8"	0.023"	1-1/2"	2
GM-2ES-0.016"	0.016"	1/8"	0.024"	1-1/2"	2
GM-2ES-0.017"	0.017"	1/8"	0.026"	1-1/2"	2
GM-2ES-0.018"	0.018"	1/8"	0.027"	1-1/2"	2
GM-2ES-0.019"	0.019"	1/8"	0.029"	1-1/2"	2
GM-2ES-0.020"	0.020"	1/8"	0.030"	1-1/2"	2
GM-2ES-0.021"	0.021"	1/8"	0.032"	1-1/2"	2
GM-2ES-0.022"	0.022"	1/8"	0.033"	1-1/2"	2
GM-2ES-0.023"	0.023"	1/8"	0.035"	1-1/2"	2
GM-2ES-0.024"	0.024"	1/8"	0.036"	1-1/2"	2

Art.No.	Specification				
	D	d	H	L	Z
GM-2ES-0.025"	0.025"	1/8"	0.038"	1-1/2"	2
GM-2ES-0.026"	0.026"	1/8"	0.039"	1-1/2"	2
GM-2ES-0.027"	0.027"	1/8"	0.041"	1-1/2"	2
GM-2ES-0.028"	0.028"	1/8"	0.042"	1-1/2"	2
GM-2ES-0.029"	0.029"	1/8"	0.044"	1-1/2"	2
GM-2ES-0.030"	0.030"	1/8"	0.045"	1-1/2"	2
GM-2ES-0.031"	0.031"	1/8"	0.047"	1-1/2"	2
GM-2ES-0.035"	0.035"	1/8"	0.053"	1-1/2"	2
GM-2ES-0.040"	0.040"	1/8"	0.060"	1-1/2"	2
GM-2ES-0.047"	0.047"	1/8"	0.071"	1-1/2"	2
GM-2ES-0.050"	0.050"	1/8"	0.075"	1-1/2"	2
GM-2ES-0.055"	0.055"	1/8"	0.083"	1-1/2"	2
GM-2ES-0.060"	0.060"	1/8"	0.090"	1-1/2"	2

2-flute R end mills with straight shank

GM-2R

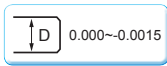
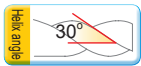
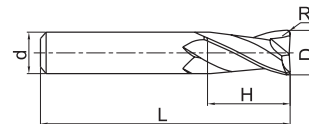

Art.No.	Specification					
	D	R	d	H	L	Z
GM-2R-1/8"R015	1/8"	0.015"	1/8"	1/2"	1-1/2"	2
GM-2R-1/8"R020	1/8"	0.020"	1/8"	1/2"	1-1/2"	2
GM-2R-3/16"R015	3/16"	0.015"	3/16"	5/8"	2"	2
GM-2R-3/16"R020	3/16"	0.020"	3/16"	5/8"	2"	2
GM-2R-3/16"R030	3/16"	0.030"	3/16"	5/8"	2"	2
GM-2R-1/4"R015	1/4"	0.015"	1/4"	3/4"	2-1/2"	2
GM-2R-1/4"R020	1/4"	0.020"	1/4"	3/4"	2-1/2"	2
GM-2R-1/4"R030	1/4"	0.030"	1/4"	3/4"	2-1/2"	2
GM-2R-1/4"R045	1/4"	0.045"	1/4"	3/4"	2-1/2"	2
GM-2R-5/16"R015	5/16"	0.015"	5/16"	13/16"	2-1/2"	2
GM-2R-5/16"R020	5/16"	0.020"	5/16"	13/16"	2-1/2"	2

Art.No.	Specification					
	D	R	d	H	L	Z
GM-2R-5/16"R030	5/16"	0.030"	5/16"	13/16"	2-1/2"	2
GM-2R-5/16"R045	5/16"	0.045"	5/16"	13/16"	2-1/2"	2
GM-2R-3/8"R015	3/8"	0.015"	3/8"	1"	2-1/2"	2
GM-2R-3/8"R020	3/8"	0.020"	3/8"	1"	2-1/2"	2
GM-2R-3/8"R030	3/8"	0.030"	3/8"	1"	2-1/2"	2
GM-2R-3/8"R045	3/8"	0.045"	3/8"	1"	2-1/2"	2
GM-2R-1/2"R015	1/2"	0.015"	1/2"	1"	3"	2
GM-2R-1/2"R020	1/2"	0.020"	1/2"	1"	3"	2
GM-2R-1/2"R030	1/2"	0.030"	1/2"	1"	3"	2
GM-2R-1/2"R045	1/2"	0.045"	1/2"	1"	3"	2
GM-2R-1/2"R060	1/2"	0.060"	1/2"	1"	3"	2

4-flute R end mills with straight shank

GM-4R

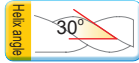
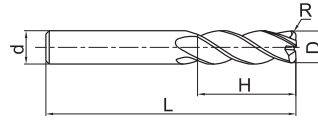

Art.No.	Specification					
	D	R	d	H	L	Z
GM-4R-1/8"R015	1/8"	0.015"	1/8"	1/2"	1-1/2"	4
GM-4R-1/8"R020	1/8"	0.020"	1/8"	1/2"	1-1/2"	4
GM-4R-3/16"R015	3/16"	0.015"	3/16"	5/8"	2"	4
GM-4R-3/16"R020	3/16"	0.020"	3/16"	5/8"	2"	4
GM-4R-3/16"R030	3/16"	0.030"	3/16"	5/8"	2"	4
GM-4R-1/4"R015	1/4"	0.015"	1/4"	3/4"	2-1/2"	4
GM-4R-1/4"R020	1/4"	0.020"	1/4"	3/4"	2-1/2"	4
GM-4R-1/4"R030	1/4"	0.030"	1/4"	3/4"	2-1/2"	4
GM-4R-1/4"R045	1/4"	0.045"	1/4"	3/4"	2-1/2"	4
GM-4R-5/16"R015	5/16"	0.015"	5/16"	13/16"	2-1/2"	4
GM-4R-5/16"R020	5/16"	0.020"	5/16"	13/16"	2-1/2"	4

Art.No.	Specification					
	D	R	d	H	L	Z
GM-4R-5/16"R030	5/16"	0.030"	5/16"	13/16"	2-1/2"	4
GM-4R-5/16"R045	5/16"	0.045"	5/16"	13/16"	2-1/2"	4
GM-4R-3/8"R015	3/8"	0.015"	3/8"	1"	2-1/2"	4
GM-4R-3/8"R020	3/8"	0.020"	3/8"	1"	2-1/2"	4
GM-4R-3/8"R030	3/8"	0.030"	3/8"	1"	2-1/2"	4
GM-4R-3/8"R045	3/8"	0.045"	3/8"	1"	2-1/2"	4
GM-4R-1/2"R015	1/2"	0.015"	1/2"	1"	3"	4
GM-4R-1/2"R020	1/2"	0.020"	1/2"	1"	3"	4
GM-4R-1/2"R030	1/2"	0.030"	1/2"	1"	3"	4
GM-4R-1/2"R045	1/2"	0.045"	1/2"	1"	3"	4
GM-4R-1/2"R060	1/2"	0.060"	1/2"	1"	3"	4

4-flute flattened end mills with straight shank and corrugated edges

GM-4W

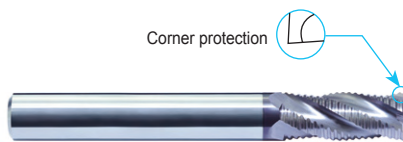

Corner protection

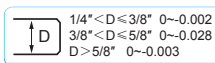
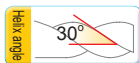
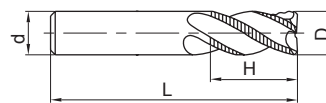

Art.No.	Specification				
	D	d	H	L	Z
GM-4W-1/4"	1/4"	1/4"	3/4"	2-1/2"	4
GM-4W-3/8"	3/8"	3/8"	1"	2-1/2"	4
GM-4W-1/2"	1/2"	1/2"	1-1/4"	3"	4
GM-4W-5/8"	5/8"	5/8"	1-1/2"	3-1/2"	4
GM-4W-3/4"	3/4"	3/4"	1-3/4"	4"	4



HMX series

end mills for high-hardness steel machining

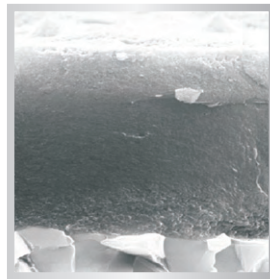

Lattice heterogeneous coating

Lattice heterogeneous coating added with special elements, with high hardness and excellent high temperature oxidation resistance, more suitable for high hardness materials and high speed machining

Excellent coating processing technology, more closely combined with substrate

New technology
Breakthrough upgrading

- ⚙️ unique cutter structure, properly designed chipbreaker, for outstanding cutting performance.
- ⚙️ Orange red coating allows for better wear observation.
- ⚙️ Special after treatment greatly reduces friction, for smoother chip evacuation and superior surface quality.

Perfect high temperature oxidation resistance:

After oxidation at 1100 ° C, HMX series cutter coating only has a very thin oxide layer, while the similar products of Company A has completely oxidized.

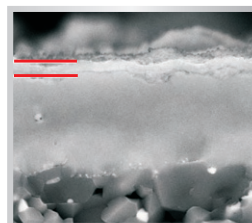

HMX series

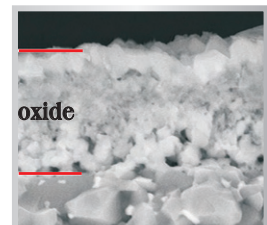

A company

HMX series end mills for high-hardness steel machining



Longer tool life

tool: HMX-4E-1/16"
 workpiece material: SKD11(62HRC)
 cutting speed: 320SFPM
 feed per tooth: 0.0079in/r
 axial depth of cut: $a_p=0.3937$ in
 radial depth of cut: $a_e=0.0118$ in
 cooling system: air cooling



wear comparison after machining 60min

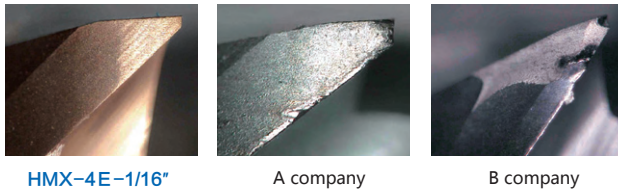

HMX-4E-1/16"

A company

B company

peripheral edges wear curves

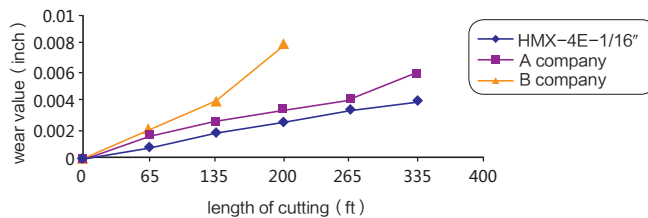

tool: HMX-4EL-1/4"

milling method: end milling
 workpiece material: D2 mod.
 cutting speed: 320SFPM
 feed per revolution: 0.0059in/r
 depth of cut: 0.0118in
 cutting width: 0.1969in
 cooling system: air cooling

wear comparison after machining 40min

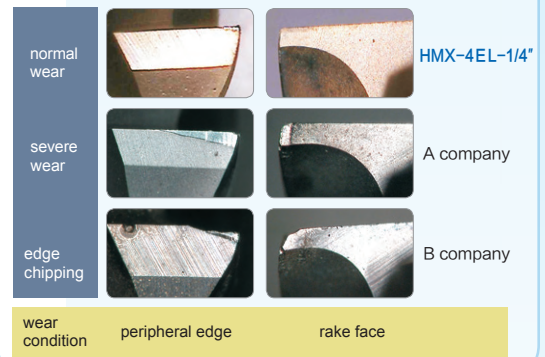

high machining efficient

tool: HMX-4E-1/4"

machining parts: cavity machining
 (1.2in×1.2in×0.4in)
 workpiece material: D2 mod.
 cutting speed: 650SFPM
 feed per revolution: 0.0079in/r
 cutting width: 0.0118in
 cutting depth: 0.1969in
 cooling system: air cooling

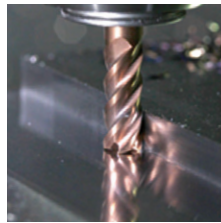

time comparison for complete one cavity

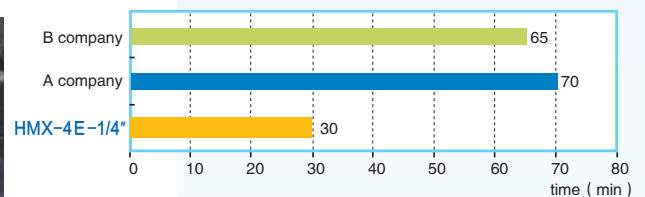

100% Improvement of machining efficient on HMX than others!

Good machining quality

tool: HMX-2B-1/4"

workpiece material: SKD11(HRC62)
 cutting speed : 650SFPM
 feed per revolution: 0.0079in/r
 cutting width: 0.0079in
 cutting depth: 0.0118in
 cooling system: air cooling

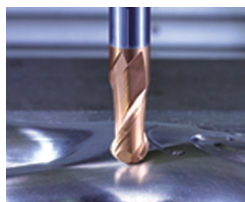

surface roughness curves of machined surface

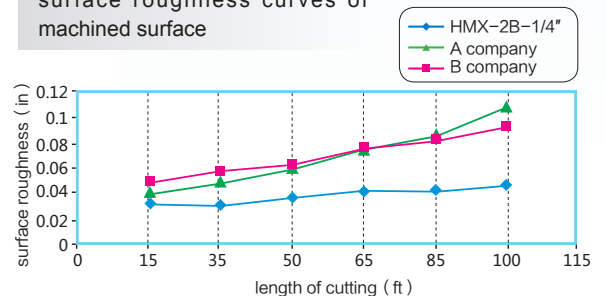

4-flute flattened end mills with straight shank

HMX-4E

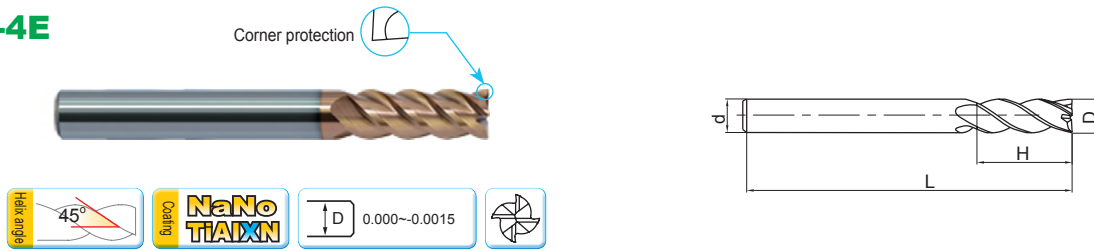

Art.No.	Specification				
	D	d	H	L	Z
HMX-4E-3/64"	3/64"	1/8"	7/64"	1-1/2"	4
HMX-4E-1/16"	1/16"	1/8"	3/16"	1-1/2"	4
HMX-4E-5/64"	5/64"	1/8"	3/16"	1-1/2"	4
HMX-4E-3/32"	3/32"	1/8"	9/32"	1-1/2"	4
HMX-4E-7/64"	7/64"	1/8"	3/8"	1-1/2"	4
HMX-4E-1/8"	1/8"	1/8"	1/2"	1-1/2"	4
HMX-4E-9/64"	9/64"	3/16"	1/2"	2"	4
HMX-4E-5/32"	5/32"	3/16"	1/2"	2"	4
HMX-4E-11/64"	11/64"	3/16"	5/8"	2"	4
HMX-4E-3/16"	3/16"	3/16"	5/8"	2"	4
HMX-4E-13/64"	13/64"	1/4"	5/8"	2-1/2"	4
HMX-4E-7/32"	7/32"	1/4"	5/8"	2-1/2"	4
HMX-4E-15/64"	15/64"	1/4"	3/4"	2-1/2"	4
HMX-4E-1/4"	1/4"	1/4"	3/4"	2-1/2"	4
HMX-4E-17/64"	17/64"	5/16"	3/4"	2-1/2"	4
HMX-4E-9/32"	9/32"	5/16"	3/4"	2-1/2"	4
HMX-4E-19/64"	19/64"	5/16"	13/16"	2-1/2"	4
HMX-4E-5/16"	5/16"	5/16"	13/16"	2-1/2"	4

Art.No.	Specification				
	D	d	H	L	Z
HMX-4E-21/64"	21/64"	3/8"	1"	2-1/2"	4
HMX-4E-11/32"	11/32"	3/8"	1"	2-1/2"	4
HMX-4E-23/64"	23/64"	3/8"	1"	2-1/2"	4
HMX-4E-3/8"	3/8"	3/8"	1"	2-1/2"	4
HMX-4E-25/64"	25/64"	7/16"	1"	2-3/4"	4
HMX-4E-13/32"	13/32"	7/16"	1"	2-3/4"	4
HMX-4E-27/64"	27/64"	7/16"	1"	2-3/4"	4
HMX-4E-7/16"	7/16"	7/16"	1"	2-3/4"	4
HMX-4E-29/64"	29/64"	1/2"	1"	3"	4
HMX-4E-15/32"	15/32"	1/2"	1"	3"	4
HMX-4E-31/64"	31/64"	1/2"	1"	3"	4
HMX-4E-1/2"	1/2"	1/2"	1-1/8"	3"	4
HMX-4E-9/16"	9/16"	9/16"	1-1/8"	3-1/2"	4
HMX-4E-5/8"	5/8"	5/8"	1-1/4"	3-1/2"	4
HMX-4E-11/16"	11/16"	3/4"	1-3/8"	4"	4
HMX-4E-3/4"	3/4"	3/4"	1-5/8"	4"	4
HMX-4E-7/8"	7/8"	7/8"	1-5/8"	4"	4
HMX-4E-1"	1"	1"	1-5/8"	4"	4

4-flute flattened long cutting edge end mills with straight shank

HMX-4EL

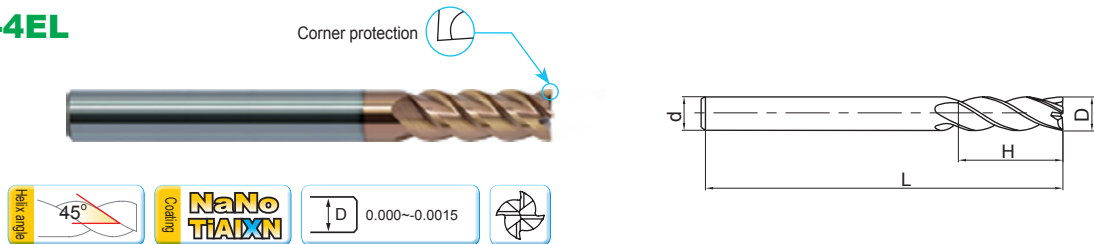

Art.No.	Specification				
	D	d	H	L	Z
HMX-4EL-1/8"	1/8"	1/8"	3/4"	2-1/4"	4
HMX-4EL-3/16"	3/16"	3/16"	3/4"	2-1/2"	4
HMX-4EL-1/4"	1/4"	1/4"	1-1/2"	3"	4
HMX-4EL-5/16"	5/16"	5/16"	1-1/2"	3"	4
HMX-4EL-3/8"	3/8"	3/8"	1-1/2"	3"	4

Art.No.	Specification				
	D	d	H	L	Z
HMX-4EL-7/16"	7/16"	7/16"	2-1/8"	4-1/2"	4
HMX-4EL-1/2"	1/2"	1/2"	2-1/8"	4-1/2"	4
HMX-4EL-5/8"	5/8"	5/8"	2-1/2"	5"	4
HMX-4EL-3/4"	3/4"	3/4"	2-1/2"	5"	4
HMX-4EL-1"	1"	1"	2-1/2"	5"	4

2-flute ball nose end mills with straight shank

HMX-2B

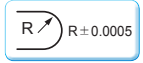
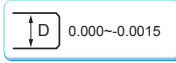
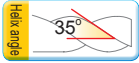
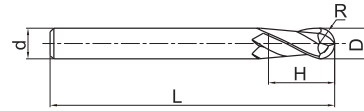

Art.No.	Specification				
	D	d	H	L	Z
HMX-2B-1/32"	1/32"	1/8"	5/64"	1-1/2"	2
HMX-2B-3/64"	3/64"	1/8"	7/64"	1-1/2"	2
HMX-2B-1/16"	1/16"	1/8"	3/16"	1-1/2"	2
HMX-2B-5/64"	5/64"	1/8"	3/16"	1-1/2"	2
HMX-2B-3/32"	3/32"	1/8"	9/32"	1-1/2"	2
HMX-2B-7/64"	7/64"	1/8"	3/8"	1-1/2"	2
HMX-2B-1/8"	1/8"	1/8"	1/2"	1-1/2"	2
HMX-2B-9/64"	9/64"	3/16"	1/2"	2"	2
HMX-2B-5/32"	5/32"	3/16"	1/2"	2"	2
HMX-2B-11/64"	11/64"	3/16"	5/8"	2"	2
HMX-2B-3/16"	3/16"	3/16"	5/8"	2"	2
HMX-2B-13/64"	13/64"	1/4"	5/8"	2-1/2"	2
HMX-2B-7/32"	7/32"	1/4"	5/8"	2-1/2"	2
HMX-2B-15/64"	15/64"	1/4"	3/4"	2-1/2"	2
HMX-2B-1/4"	1/4"	1/4"	3/4"	2-1/2"	2
HMX-2B-17/64"	17/64"	5/16"	3/4"	2-1/2"	2
HMX-2B-9/32"	9/32"	5/16"	3/4"	2-1/2"	2
HMX-2B-19/64"	19/64"	5/16"	13/16"	2-1/2"	2
HMX-2B-5/16"	5/16"	5/16"	13/16"	2-1/2"	2

Art.No.	Specification				
	D	d	H	L	Z
HMX-2B-21/64"	21/64"	3/8"	1"	2-1/2"	2
HMX-2B-11/32"	11/32"	3/8"	1"	2-1/2"	2
HMX-2B-23/64"	23/64"	3/8"	1"	2-1/2"	2
HMX-2B-3/8"	3/8"	3/8"	1"	2-1/2"	2
HMX-2B-25/64"	25/64"	7/16"	1"	2-3/4"	2
HMX-2B-13/32"	13/32"	7/16"	1"	2-3/4"	2
HMX-2B-27/64"	27/64"	7/16"	1"	2-3/4"	2
HMX-2B-7/16"	7/16"	7/16"	1"	2-3/4"	2
HMX-2B-29/64"	29/64"	1/2"	1"	3"	2
HMX-2B-15/32"	15/32"	1/2"	1"	3"	2
HMX-2B-31/64"	31/64"	1/2"	1"	3"	2
HMX-2B-1/2"	1/2"	1/2"	1"	3"	2
HMX-2B-9/16"	9/16"	9/16"	1-1/8"	3-1/2"	2
HMX-2B-5/8"	5/8"	5/8"	1-1/4"	3-1/2"	2
HMX-2B-11/16"	11/16"	3/4"	1-3/8"	4"	2
HMX-2B-3/4"	3/4"	3/4"	1-1/2"	4"	2
HMX-2B-7/8"	7/8"	7/8"	1-1/2"	4"	2
HMX-2B-1"	1"	1"	1-1/2"	4"	2

2-flute ball nose end mills with long straight shank

HMX-2BL

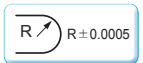
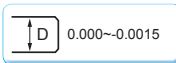
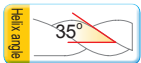
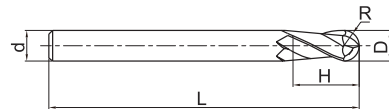

Art.No.	Specification				
	D	d	H	L	Z
HMX-2BL-1/8"	1/8"	1/8"	3/4"	2-1/4"	2
HMX-2BL-3/16"	3/16"	3/16"	3/4"	2-1/2"	2
HMX-2BL-1/4"	1/4"	1/4"	1-1/8"	3"	2
HMX-2BL-5/16"	5/16"	5/16"	1-1/8"	3"	2
HMX-2BL-3/8"	3/8"	3/8"	1-1/8"	3"	2

Art.No.	Specification				
	D	d	H	L	Z
HMX-2BL-7/16"	7/16"	7/16"	2"	4-1/2"	2
HMX-2BL-1/2"	1/2"	1/2"	2"	4-1/2"	2
HMX-2BL-5/8"	5/8"	5/8"	2-1/4"	5"	2
HMX-2BL-3/4"	3/4"	3/4"	2-1/4"	5"	2
HMX-2BL-1"	1"	1"	2-1/4"	5"	2

2-flute flattened end mills with straight shank

AL-2E

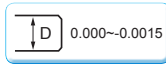
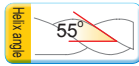
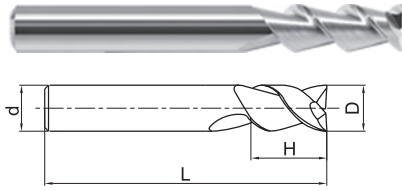

3-flute flattened end mills with straight shank

AL-3E

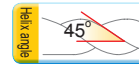
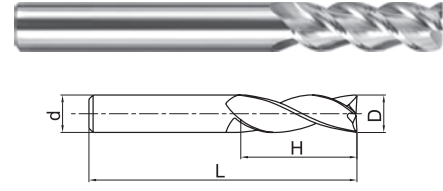

Art.No.	Specification				
	D	d	H	L	Z
AL-2E-1/16"	1/16"	1/8"	3/16"	1-1/2"	2
AL-2E-3/32"	3/32"	1/8"	3/8"	1-1/2"	2
AL-2E-1/8"	1/8"	1/8"	7/16"	1-1/2"	2
AL-2E-5/32"	5/32"	3/16"	9/16"	2"	2
AL-2E-3/16"	3/16"	3/16"	9/16"	2"	2
AL-2E-7/32"	7/32"	1/4"	5/8"	2-1/2"	2
AL-2E-1/4"	1/4"	1/4"	3/4"	2-1/2"	2
AL-2E-9/32"	9/32"	5/16"	3/4"	2-1/2"	2
AL-2E-5/16"	5/16"	5/16"	13/16"	2-1/2"	2
AL-2E-3/8"	3/8"	3/8"	7/8"	2-1/2"	2
AL-2E-7/16"	7/16"	7/16"	1"	2-3/4"	2
AL-2E-1/2"	1/2"	1/2"	1"	3"	2
AL-2E-9/16"	9/16"	9/16"	1-1/8"	3-1/2"	2
AL-2E-5/8"	5/8"	5/8"	1-1/4"	3-1/2"	2
AL-2E-3/4"	3/4"	3/4"	1-1/2"	4"	2
AL-2E-1"	1"	1"	1-1/2"	4"	2

Art.No.	Specification				
	D	d	H	L	Z
AL-3E-1/16"	1/16"	1/8"	3/16"	1-1/2"	3
AL-3E-3/32"	3/32"	1/8"	3/8"	1-1/2"	3
AL-3E-1/8"	1/8"	1/8"	7/16"	1-1/2"	3
AL-3E-5/32"	5/32"	3/16"	9/16"	2"	3
AL-3E-3/16"	3/16"	3/16"	9/16"	2"	3
AL-3E-7/32"	7/32"	1/4"	5/8"	2-1/2"	3
AL-3E-1/4"	1/4"	1/4"	3/4"	2-1/2"	3
AL-3E-9/32"	9/32"	5/16"	3/4"	2-1/2"	3
AL-3E-5/16"	5/16"	5/16"	13/16"	2-1/2"	3
AL-3E-3/8"	3/8"	3/8"	7/8"	2-1/2"	3
AL-3E-7/16"	7/16"	7/16"	1"	2-3/4"	3
AL-3E-1/2"	1/2"	1/2"	1"	3"	3
AL-3E-9/16"	9/16"	9/16"	1-1/8"	3-1/2"	3
AL-3E-5/8"	5/8"	5/8"	1-1/4"	3-1/2"	3
AL-3E-3/4"	3/4"	3/4"	1-1/2"	4"	3
AL-3E-1"	1"	1"	1-1/2"	4"	3

2-flute ball nose end mills with straight shank

AL-2B

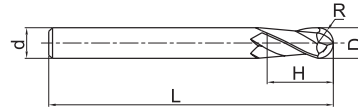

Art.No.	Specification				
	D	d	H	L	Z
AL-2B-1/8"	1/8"	1/4"	3/8"	2-1/2"	2
AL-2B-3/16"	3/16"	1/4"	9/16"	3"	2
AL-2B-1/4"	1/4"	1/4"	5/8"	3-1/2"	2
AL-2B-5/16"	5/16"	5/16"	11/16"	4"	2

Art.No.	Specification				
	D	d	H	L	Z
AL-2B-3/8"	3/8"	3/8"	7/8"	4"	2
AL-2B-1/2"	1/2"	1/2"	1"	4-1/2"	2
AL-2B-5/8"	5/8"	5/8"	1-1/8"	5"	2
AL-2B-3/4"	3/4"	3/4"	1-3/8"	5-1/4"	2

2-flute R end mills with straight shank

AL-2R-AIR for high-speed milling

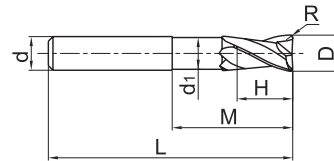

Ordering number	Basic dimension(mm)							Number of teeth Z	Stock
	D	R	d	d ₁	H	M	L		
AL-2R-1/2"- AIR	1/2"	0.0547	1/2"	0.4803"	3/8"	1-3/8"	3-1/4"	2	○
AL-2R-5/8"- AIR	5/8"	0.0625	5/8"	0.6053"	1/2"	1-1/2"	3-1/2"	2	○
AL-2R-3/4"- AIR	3/4"	0.0781	3/4"	0.7303"	9/16"	1-7/8"	4"	2	○

**High performance universal
machining end mills**

UJM series

Variable pitch flutes with a variable helix reduce vibrations and allow for smoother cutting performance.

The variable helix in the flutes and the variation in the flute gullets afford greater stability with improved chip evacuation and higher feed rates.



Workpiece material: Precipitation Hardened Mold Steel

Milling style: cavity machining

Tool type: UM-4E-25/64"

Cutting parameter: $n=5000\sim 6000\text{r/min}$,

$fz=0.002\sim 0.006\text{in/z}$

$a_p=.400"$, $a_e=.040"$

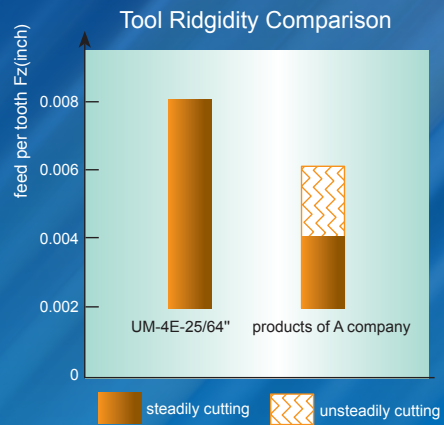

Flank Wear Comparison

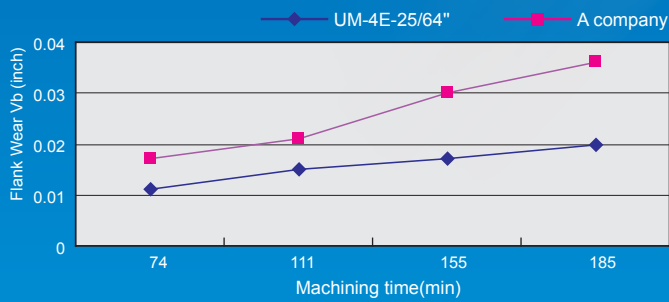

4-flute unequal pitch flattened end mills with straight shank

UM-4E

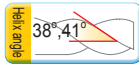
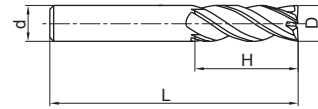

Art.No.	Specification				
	D	d	H	L	Z
UM-4E-3/64"	3/64"	1/8"	7/64"	1-1/2"	4
UM-4E-1/16"	1/16"	1/8"	3/16"	1-1/2"	4
UM-4E-5/64"	5/64"	1/8"	3/16"	1-1/2"	4
UM-4E-3/32"	3/32"	1/8"	9/32"	1-1/2"	4
UM-4E-7/64"	7/64"	1/8"	3/8"	1-1/2"	4
UM-4E-1/8"	1/8"	1/8"	1/2"	1-1/2"	4
UM-4E-9/64"	9/64"	3/16"	1/2"	2"	4
UM-4E-5/32"	5/32"	3/16"	1/2"	2"	4
UM-4E-11/64"	11/64"	3/16"	5/8"	2"	4
UM-4E-3/16"	3/16"	3/16"	5/8"	2"	4
UM-4E-13/64"	13/64"	1/4"	5/8"	2-1/2"	4
UM-4E-7/32"	7/32"	1/4"	5/8"	2-1/2"	4
UM-4E-15/64"	15/64"	1/4"	3/4"	2-1/2"	4
UM-4E-1/4"	1/4"	1/4"	3/4"	2-1/2"	4
UM-4E-17/64"	17/64"	5/16"	3/4"	2-1/2"	4
UM-4E-9/32"	9/32"	5/16"	3/4"	2-1/2"	4
UM-4E-19/64"	19/64"	5/16"	13/16"	2-1/2"	4
UM-4E-5/16"	5/16"	5/16"	13/16"	2-1/2"	4

Art.No.	Specification				
	D	d	H	L	Z
UM-4E-21/64"	21/64"	3/8"	1"	2-1/2"	4
UM-4E-11/32"	11/32"	3/8"	1"	2-1/2"	4
UM-4E-23/64"	23/64"	3/8"	1"	2-1/2"	4
UM-4E-3/8"	3/8"	3/8"	1"	2-1/2"	4
UM-4E-25/64"	25/64"	7/16"	1"	2-3/4"	4
UM-4E-13/32"	13/32"	7/16"	1"	2-3/4"	4
UM-4E-27/64"	27/64"	7/16"	1"	2-3/4"	4
UM-4E-7/16"	7/16"	7/16"	1"	2-3/4"	4
UM-4E-29/64"	29/64"	1/2"	1"	3"	4
UM-4E-15/32"	15/32"	1/2"	1"	3"	4
UM-4E-31/64"	31/64"	1/2"	1"	3"	4
UM-4E-1/2"	1/2"	1/2"	1-1/8"	3"	4
UM-4E-9/16"	9/16"	9/16"	1-1/8"	3-1/2"	4
UM-4E-5/8"	5/8"	5/8"	1-1/4"	3-1/2"	4
UM-4E-11/16"	11/16"	3/4"	1-3/8"	4"	4
UM-4E-3/4"	3/4"	3/4"	1-5/8"	4"	4
UM-4E-7/8"	7/8"	7/8"	1-5/8"	4"	4
UM-4E-1"	1"	1"	1-5/8"	4"	4

4-flute long cutting edge and unequal pitch flattened end mill with straight shank

UM-4EL

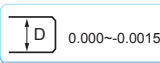
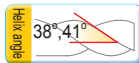
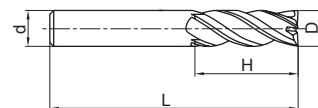

Art.No.	Specification				
	D	d	H	L	Z
UM-4EL-1/8"	1/8"	1/8"	3/4"	2-1/4"	4
UM-4EL-3/16"	3/16"	3/16"	3/4"	2-1/2"	4
UM-4EL-1/4"	1/4"	1/4"	1-1/8"	3"	4
UM-4EL-5/16"	5/16"	5/16"	1-1/8"	3"	4
UM-4EL-3/8"	3/8"	3/8"	1-1/8"	3"	4

Art.No.	Specification				
	D	d	H	L	Z
UM-4EL-7/16"	7/16"	7/16"	2"	4-1/2"	4
UM-4EL-1/2"	1/2"	1/2"	2-1/8"	4-1/2"	4
UM-4EL-5/8"	5/8"	5/8"	2-1/2"	5"	4
UM-4EL-3/4"	3/4"	3/4"	2-1/2"	5"	4
UM-4EL-1"	1"	1"	2-1/2"	5"	4

VSM series

VSM series end mills

Unequal pitch and variable inclined angle design

Very suitable for machining of hard-to-cut materials

such as stainless steel,

Ni substrate high temperature alloy, etc.

VSM-4E

VSM-4RFP

VSM-4EFP

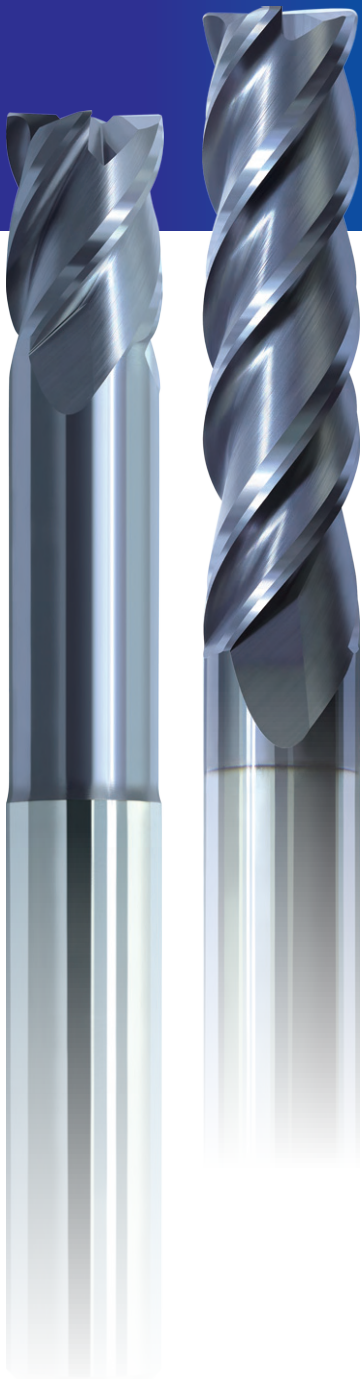

🔧 VSM-4E-1/2" Slot Milling of Stainless Steel

Machine Tool : MIKRON UCP1000

Tool Holder : HSK63-A

Workpiece Material : 1Cr18Ni9Ti

Cutting Speed : 3150 RPM

Feed Rate/ Tooth : 0.002/ tooth

Axial Cutting Depth : 1/4"

Radial Cutting Depth : 1/2"

Cooling Method : Water Cooling

Milling Style : Slot Milling

Overhang : 1-3/8"

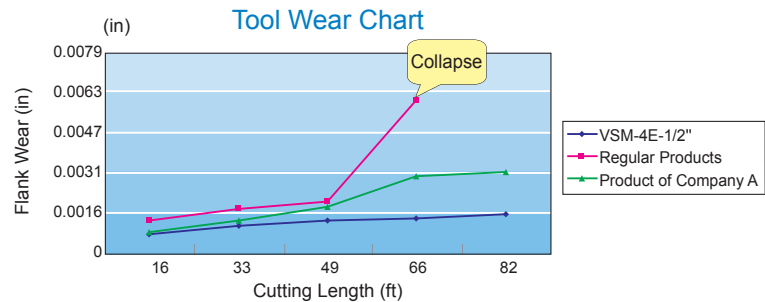
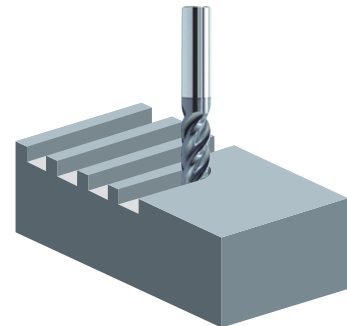

Note: • Compare with similar products, VSM Endmills have better wear resistance and longer tool life.

• Compare with ordinary endmills, VSM series have a much better chipping resistance.

4-flute unequal pitch flattened end mill with straight shank

VSM-4E

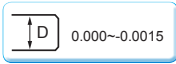
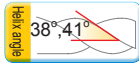
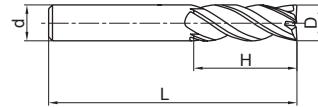

Art.No.	Specification				
	D	d	H	L	Z
VSM-4E-1/4"	1/4"	1/4"	3/4"	2-1/2"	4
VSM-4E-3/8"	3/8"	3/8"	1"	2-1/2"	4
VSM-4E-1/2"	1/2"	1/2"	1-1/4"	3"	4
VSM-4E-5/8"	5/8"	5/8"	1-1/2"	3-1/2"	4
VSM-4E-3/4"	3/4"	3/4"	1-3/4"	4"	4
VSM-4E-1"	1"	1"	1-3/4"	4"	4

E



4-flute unequal pitch flattened end mill with long neck, short cutting edge and straight shank

VSM-4EFP

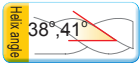
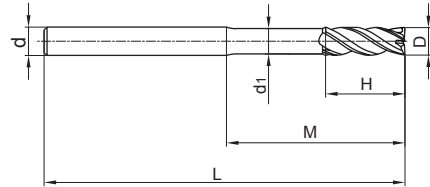

Art.No.	Specification						
	D	d	H	M	d ₁	L	Z
VSM-4EFP-1/4"	1/4"	1/4"	3/8"	1-1/16"	15/64"	3"	4
VSM-4EFP-3/8"	3/8"	3/8"	1/2"	1-1/2"	23/64"	4"	4
VSM-4EFP-1/2"	1/2"	1/2"	5/8"	2"	31/64"	4"	4
VSM-4EFP-5/8"	5/8"	5/8"	3/4"	2-3/8"	39/64"	6"	4

4-flute long neck and short cutting edge unequal pitch R end mill with straight shank

VSM-4RFP

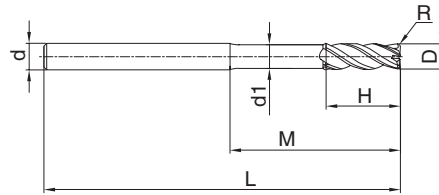

Art.No.	Specification							
	D	R	d	d ₁	H	M	L	Z
VSM-4RFP-1/4" R020	1/4"	0.020"	1/4"	15/64"	3/8"	1-1/16"	3"	4
VSM-4RFP-1/4" R040	1/4"	0.040"	1/4"	15/64"	3/8"	1-1/16"	3"	4
VSM-4RFP-3/8" R020	3/8"	0.020"	3/8"	23/64"	1/2"	1-1/2"	4"	4
VSM-4RFP-3/8" R040	3/8"	0.040"	3/8"	23/64"	1/2"	1-1/2"	4"	4
VSM-4RFP-1/2" R020	1/2"	0.020"	1/2"	31/64"	1/2"	1-1/2"	4"	4
VSM-4RFP-1/2" R040	1/2"	0.040"	1/2"	31/64"	1/2"	1-1/2"	4"	4
VSM-4RFP-5/8" R030	5/8"	0.030"	5/8"	39/64"	3/4"	2-3/8"	6"	4
VSM-4RFP-5/8" R060	5/8"	0.060"	5/8"	39/64"	3/4"	2-3/8"	6"	4

Cutting data of GM series flattened end mills

Workpiece materials	Carbon steel, alloy steel, tool steel, die steel		Alloy steel, tool steel, die steel, hardened steel		Alloy steel, tool steel, Stainless steel, die steel, hardened steel		Hardened steel, Ti alloy		Hardened steel, heat-resistant steel, Ni-based alloy	
	HRC<30		HRC(30-35)		HRC(35-40)		HRC(40-45)		HRC(45-50)	
Hardness of workpiece materials	Rotation speed (r/min)	Feed (in/z)	Rotation speed (r/min)	Feed (in/z)	Rotation speed (r/min)	Feed (in/z)	Rotation speed (r/min)	Feed (in/z)	Rotation speed (r/min)	Feed (in/z)
Cutting edge diameter of end mills (inch)										
1/32"	25000	0.00008	21000	0.00008	16800	0.00008	14500	0.00008	5200	0.00008
3/64"	20000	0.00010	16700	0.00010	13400	0.00010	11700	0.00010	4200	0.00010
1/16"	14000	0.00016	12000	0.00016	9600	0.00016	8400	0.00016	3000	0.00016
5/64"	13000	0.00020	11000	0.00020	8800	0.00020	7700	0.00020	2800	0.00020
3/32"	12000	0.00024	9200	0.00024	7400	0.00024	6400	0.00024	2300	0.00024
7/64"	12000	0.00028	9200	0.00028	7400	0.00028	6400	0.00028	2300	0.00028
1/8"	12000	0.00032	9200	0.00032	7400	0.00032	6400	0.00032	2300	0.00032
9/64"	10600	0.00040	8800	0.00040	7000	0.00040	6100	0.00040	2200	0.00040
5/32"	9600	0.00052	8000	0.00052	6400	0.00052	5600	0.00052	2000	0.00052
11/64"	8600	0.00060	7200	0.00060	5700	0.00060	5000	0.00060	1800	0.00060
3/16"	8000	0.00064	6700	0.00064	5400	0.00064	4700	0.00064	1700	0.00064
13/64"	7400	0.00072	6200	0.00072	5000	0.00072	4300	0.00072	1600	0.00072
7/32"	6800	0.00080	5700	0.00080	4600	0.00080	4000	0.00080	1400	0.00080
15/64"	6400	0.00096	5300	0.00096	4200	0.00096	3700	0.00096	1300	0.00096
1/4"	6000	0.0010	5000	0.0010	4000	0.0010	3500	0.0010	1300	0.0010
17/64"	5600	0.0010	4600	0.0010	3700	0.0010	3200	0.0010	1200	0.0010
9/32"	5300	0.00112	4400	0.00112	3500	0.00112	3000	0.00112	1100	0.00112
19/64"	5000	0.00120	4200	0.00120	3300	0.00120	2900	0.00120	1100	0.00120
5/16"	4800	0.00128	4000	0.00128	3200	0.00128	2800	0.00128	1000	0.00128
21/64"	4500	0.00128	3700	0.00128	3000	0.00128	2600	0.00128	950	0.00128
11/32"	4300	0.00136	3600	0.00136	2900	0.00136	2500	0.00136	900	0.00136
23/64"	4100	0.00144	3400	0.00144	2700	0.00144	2400	0.00144	850	0.00144
3/8"	4000	0.00152	3300	0.00152	2600	0.00152	2300	0.00152	850	0.00152
25/64"	3800	0.00160	3200	0.00160	2500	0.00160	2200	0.00160	800	0.00160
13/32"	3600	0.00168	3000	0.00168	2400	0.00168	2100	0.00168	750	0.00168
27/64"	3500	0.00176	2900	0.00176	2300	0.00176	2000	0.00176	750	0.00176
7/16"	3400	0.00184	2800	0.00184	2200	0.00184	1900	0.00184	700	0.00184
29/64"	3300	0.00192	2700	0.00192	2100	0.00192	1800	0.00192	700	0.00192
15/32"	3100	0.00200	2600	0.00200	2000	0.00200	1700	0.00200	650	0.00200
31/64"	3000	0.00200	2500	0.00200	2000	0.00200	1600	0.00200	600	0.00200
1/2"	3000	0.00200	2500	0.00200	2000	0.00200	1600	0.00200	600	0.00200
9/16"	2600	0.00200	2200	0.00200	1800	0.00200	1600	0.00200	550	0.00200
5/8"	2400	0.00200	2000	0.00200	1600	0.00200	1400	0.00200	500	0.00200
11/16"	2200	0.00200	1800	0.00200	1400	0.00200	1300	0.00200	450	0.00200
3/4"	2000	0.00200	1600	0.00200	1300	0.00200	1100	0.00200	400	0.00200
7/8"	1700	0.00240	1400	0.00240	1100	0.00240	1000	0.00240	350	0.00240
1"	1500	0.00320	1250	0.00320	1000	0.00320	700	0.00320	300	0.00320

Cutting data of GM series flattened end mills

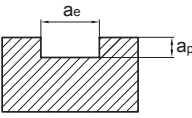
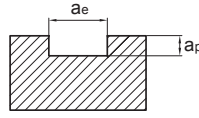
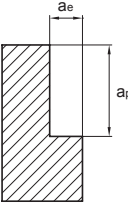
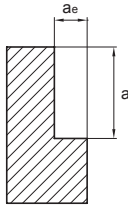
Workpiece materials	Carbon steel, alloy steel, tool steel, die steel	Alloy steel, tool steel, die steel, hardened steel	Alloy steel, tool steel, Stainless steel, die steel, hardened steel	Hardened steel, Ti alloy	Hardened steel, heat-resistant steel, Ni-based alloy
Hardness of workpiece materials	HRC<30	HRC(30-35)	HRC(35-40)	HRC(40-45)	HRC(45-50)
Max cutting data (Feed speed 100%)	 <p>$a_e < 1/8 \text{ inch}$, $a_p < 0.15D$ $a_e > 1/8 \text{ inch}$, $a_p < 0.25D$</p>			 <p>$a_e < 1/8 \text{ inch}$, $a_p < 0.05D$ $a_e > 1/8 \text{ inch}$, $a_p < 0.10D$</p>	
Max cutting data (Feed speed 120%)	 <p>$a_p < 1.5D$, $a_e < 0.05D$</p>			 <p>$a_p < 1.5D$, $a_e < 0.025D$</p>	

- We suggest a feed and speed 50% of that stated as a starting point and gradually increase as machining stability is determined.
- A high quality and precision end mill toolholding system is highly recommended. Runout of alignment should not exceed .0004". Reduce tool overhang, as much as possible.

Cutting parameters of GM series ball nose end mills

Workpiece materials	Carbon steel, alloy steel, tool steel				Alloy steel, tool steel, Stainless steel, treatment steel				Hardened steel			
Hardness of workpiece materials	HRC<30				HRC(30-45)				HRC(40-50)			
Cutting edge diameter of end mills (inch)	Contour milling		Profile milling		Contour milling		Profile milling		Contour milling		Profile milling	
	Rotation speed (r/min)	Feed (in/z)	Rotation speed (r/min)	Feed (in/z)	Rotation speed (r/min)	Feed (in/z)	Rotation speed (r/min)	Feed (in/z)	Rotation speed (r/min)	Feed (in/z)	Rotation speed (r/min)	Feed (in/z)
1/32"	40000	0.0002	32000	0.0002	34000	0.00016	28000	0.00016	20000	0.00012	12000	0.00012
3/64"	37000	0.0004	26500	0.0004	32000	0.00032	21000	0.00032	16000	0.00024	11000	0.00024
1/16"	28000	0.0006	20000	0.0006	24000	0.00048	16000	0.00048	12000	0.00032	8000	0.00032
5/64"	22300	0.0008	16000	0.0008	19000	0.00064	13000	0.00064	9500	0.00044	7000	0.00044
3/32"	18600	0.00092	13000	0.00092	16000	0.00072	10600	0.00072	8000	0.00052	5300	0.00052
7/64"	16000	0.00104	11400	0.00104	14000	0.0008	9000	0.0008	7000	0.0006	4500	0.0006
1/8"	14000	0.0012	10000	0.0012	12000	0.00096	8000	0.00096	6000	0.00068	4000	0.00068
9/64"	12400	0.0014	8800	0.0014	11000	0.0012	7100	0.0012	5500	0.00088	3600	0.00088
5/32"	11100	0.0016	8000	0.0016	10000	0.0014	6400	0.0014	5000	0.00112	3200	0.00112
11/64"	10100	0.00172	7200	0.00172	8700	0.0016	5800	0.0016	4400	0.00132	2900	0.00132
3/16"	9300	0.00184	6600	0.00184	8000	0.00168	5300	0.00168	4000	0.0014	2700	0.0014
13/64"	8600	0.002	6100	0.002	7400	0.0018	4900	0.0018	3700	0.00152	2500	0.00152
7/32"	8000	0.0022	5700	0.0022	6800	0.0020	4500	0.0020	3400	0.00168	2300	0.00168
15/64"	7400	0.0024	5300	0.0024	6400	0.00224	4200	0.00224	3200	0.00188	2100	0.00188
1/4"	7000	0.0026	5000	0.0026	6000	0.0024	4000	0.0024	3000	0.002	2000	0.002
17/64"	6500	0.0028	4700	0.0028	5600	0.0026	3700	0.0026	2800	0.0022	1900	0.0022
9/32"	6200	0.0032	4400	0.0032	5300	0.003	3500	0.003	2700	0.0024	1800	0.0024
19/64"	5900	0.0036	4200	0.0036	5000	0.0032	3400	0.0032	2500	0.0026	1700	0.0026
5/16"	5600	0.0040	4000	0.0040	4800	0.00344	3200	0.00344	2400	0.0028	1600	0.0028
21/64"	5300	0.0040	3800	0.0040	4500	0.00344	3000	0.00344	2300	0.00296	1500	0.00296
11/32"	5000	0.0042	3600	0.0042	4300	0.0036	2900	0.0036	2200	0.00316	1400	0.00316
23/64"	4800	0.0044	3500	0.0044	4200	0.0038	2800	0.0038	2100	0.00328	1400	0.00328
3/8"	4600	0.0046	3400	0.0046	4000	0.0038	2700	0.0038	2000	0.00328	1300	0.00328
25/64"	4500	0.0048	3300	0.0048	3800	0.0040	2600	0.0040	1900	0.00348	1300	0.00348
13/32"	4300	0.0048	3200	0.0048	3700	0.0040	2500	0.0040	1800	0.00348	1200	0.00348
27/64"	4100	0.0050	3100	0.0050	3500	0.0044	2400	0.0044	1600	0.00368	1200	0.00368
7/16"	4000	0.0050	3000	0.0050	3400	0.0044	2300	0.0044	1700	0.00368	1200	0.00368
29/64"	3800	0.0052	2800	0.0052	3300	0.0048	2200	0.0048	1400	0.00388	1100	0.00388
15/32"	3700	0.0052	2700	0.0052	3200	0.0048	2100	0.0048	1600	0.00388	1100	0.00388
31/64"	3600	0.0054	2600	0.0054	3100	0.0050	2000	0.0050	1500	0.0042	1000	0.0042
1/2"	3500	0.0056	2500	0.0056	3000	0.0052	1900	0.0052	1500	0.0044	1000	0.0044
9/16"	3100	0.0060	2200	0.0060	2700	0.0056	1800	0.0056	1400	0.0046	900	0.0046
5/8"	2800	0.0064	2000	0.0064	2400	0.00584	1600	0.00584	1200	0.0048	800	0.0048
11/16"	2600	0.0066	1800	0.0066	2200	0.006	1500	0.006	1100	0.00496	800	0.00496
3/4"	2400	0.0068	1700	0.0068	2000	0.0064	1300	0.0064	1000	0.00508	700	0.00508
7/8"	2000	0.0072	1500	0.0072	1700	0.0068	1100	0.0068	900	0.0052	600	0.0052
1"	1800	0.0088	1300	0.0088	1500	0.008	1000	0.008	800	0.0072	400	0.0072



Cutting parameters of GM series ball nose end mills

Workpiece materials	Carbon steel, alloy steel, tool steel, die steel	Alloy steel, tool steel, die steel, hardened steel	Hardened steel, Ti alloy
Hardness of workpiece materials	HRC<30	HRC(30-35)	HRC(40-45)
Max cutting date	<p>$a_p < 0.06R$, $a_e < 0.10R$</p>		<p>$a_p < 0.03R$, $a_e < 0.05R$</p>

- We suggest a feed and speed 50% of that stated as a starting point gradually increase as machining stability is determined.
- A high quality and precision end mill toolholding system is highly recommended. Runout of alignment should not exceed .0004".

Cutting data of GM series R end mills

Workpiece materials	Carbon steel, alloy steel, tool steel, die steel		Alloy steel, tool steel, die steel, hardened steel		Alloy steel, tool steel, Stainless steel, die steel, hardened steel		Hardened steel, Ti alloy		Hardened steel, heat-resistant steel, Ni-based alloy	
Hardness of workpiece materials	HRC<30		HRC(30-35)		HRC(35-40)		HRC(40-45)		HRC(45-50)	
Cutting edge diameter of end mills (inch)	Rotation speed (r/min)	Feed (in/z)	Rotation speed (r/min)	Feed (in/z)	Rotation speed (r/min)	Feed (in/z)	Rotation speed (r/min)	Feed (in/z)	Rotation speed (r/min)	Feed (in/z)
1/8"	12000	0.00032	9200	0.00032	7400	0.00032	6400	0.00032	2300	0.00032
3/16"	8000	0.00064	6700	0.00064	5400	0.00064	4700	0.00064	1700	0.00064
1/4"	6000	0.0010	5000	0.0010	4000	0.0010	3500	0.0010	1300	0.0010
5/16"	4800	0.00128	4000	0.00128	3200	0.00128	2800	0.00128	1000	0.00128
3/8"	4000	0.00152	3300	0.00152	2600	0.00152	2300	0.00152	850	0.00152
1/2"	3000	0.00200	2500	0.00200	2000	0.00200	1600	0.00200	600	0.00200
Max cutting date	Maximum stock removal in milling grooves (Feed speed 100%) <p>$a_p < 0.25D$</p>					Maximum stock removal in side milling (Feed speed 120%) <p>$a_p < 1.5D$, $a_e < 0.05D$</p>				

- We suggest a feed and speed 50% of that stated as a starting point and gradually increase as machining stability is determined.
- A high quality and precision end mill toolholding system is highly recommended. Runout of alignment should not exceed .0004".

Cutting parameters of GM series of tiny diameter flattened end mills

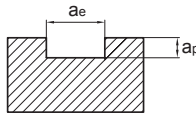
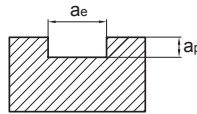
Workpiece materials	Carbon steel, alloy steel, tool steel, die steel		Alloy steel, tool steel, die steel, hardened steel		Alloy steel, tool steel, Stainless steel, die steel, hardened steel		Hardened steel, Ti alloy		Hardened steel, heat-resistant steel, Ni-based alloy	
Hardness of workpiece materials	HRC<30		HRC(30-35)		HRC(35-40)		HRC(40-45)		HRC(45-50)	
Cutting edge diameter of end mills (inch)	Rotation speed (r/min)	Feed (in/z)	Rotation speed (r/min)	Feed (in/z)	Rotation speed (r/min)	Feed (in/z)	Rotation speed (r/min)	Feed (in/z)	Rotation speed (r/min)	Feed (in/z)
0.012	32000	0.00004	32000	0.00004	29000	0.00004	24000	0.00004	18000	0.00004
0.013	32000	0.00004	32000	0.00004	29000	0.00004	24000	0.00004	18000	0.00004
0.014	32000	0.00004	32000	0.00004	29000	0.00004	24000	0.00004	18000	0.00004
0.015	32000	0.00004	32000	0.00004	29000	0.00004	24000	0.00004	18000	0.00004
0.016	32000	0.00004	32000	0.00004	29000	0.00004	24000	0.00004	18000	0.00004
0.017	32000	0.00004	32000	0.00004	29000	0.00004	24000	0.00004	18000	0.00004
0.018	32000	0.00004	32000	0.00004	29000	0.00004	24000	0.00004	18000	0.00004
0.019	32000	0.00004	32000	0.00004	29000	0.00004	24000	0.00004	18000	0.00004
0.020	32000	0.00006	32000	0.00006	29000	0.00006	24000	0.00006	18000	0.00006
0.021	32000	0.00006	32000	0.00006	29000	0.00006	24000	0.00006	18000	0.00006
0.022	32000	0.00006	32000	0.00006	29000	0.00006	24000	0.00006	18000	0.00006
0.023	32000	0.00006	32000	0.00006	29000	0.00006	24000	0.00006	18000	0.00006
0.024	32000	0.00006	32000	0.00006	29000	0.00006	24000	0.00006	18000	0.00006
0.025	32000	0.00006	32000	0.00006	29000	0.00006	24000	0.00006	18000	0.00006
0.026	32000	0.00006	32000	0.00006	29000	0.00006	24000	0.00006	18000	0.00006
0.027	32000	0.00006	32000	0.00006	29000	0.00006	24000	0.00006	18000	0.00006
0.028	32000	0.00006	32000	0.00006	29000	0.00006	24000	0.00006	18000	0.00006
0.029	32000	0.00006	32000	0.00006	29000	0.00006	24000	0.00006	18000	0.00006
0.030	32000	0.00006	32000	0.00006	29000	0.00006	24000	0.00006	18000	0.00006
0.031	25000	0.00008	21000	0.00008	16800	0.00008	14500	0.00008	5200	0.00008
0.035	25000	0.00008	21000	0.00008	16800	0.00008	14500	0.00008	5200	0.00008
0.040	25000	0.00008	21000	0.00008	16800	0.00008	14500	0.00008	5200	0.00008
0.047	20000	0.00010	16700	0.00010	13400	0.00010	11700	0.00010	4200	0.00010
0.050	20000	0.00012	16700	0.00012	13400	0.00012	11700	0.00012	4200	0.00012
0.055	14000	0.00014	12000	0.00014	9600	0.00014	8400	0.00014	3000	0.00014
0.060	14000	0.00016	12000	0.00016	9600	0.00016	8400	0.00016	3000	0.00016
Maximum stock removal in milling grooves (Feed speed 100%)	 <p>$a_e < 0.031 \text{ inch}$, $a_p < 0.1D$ $a_e > 0.031 \text{ inch}$, $a_p < 0.15D$</p>					 <p>$a_e < 0.031 \text{ inch}$, $a_p < 0.05D$ $a_e > 0.031 \text{ inch}$, $a_p < 0.10D$</p>				

- We suggest a feed and speed 50% of that stated as a starting point and gradually increase as machining stability is determined.
- A high quality and precision end mill toolholding system is highly recommended. Runout of alignment should not exceed .0004".

GM-4W — side cutting

Workpiece material	Cast iron, Nodular cast iron		Carbon steel, Alloy steel ~750N/mm ²		Carbon steel, Alloy steel ~30HRC		Pre-hardened steel, quenched and tempered steel ~40HRC		Stainless steel	
	Rotation speed (r/min)	Feed (in/min)	Rotation speed (r/min)	Feed (in/min)	Rotation speed (r/min)	Feed (in/min)	Rotation speed (r/min)	Feed (in/min)	Rotation speed (r/min)	Feed (in/min)
Cutting edge diameter of end mills (inch)										
1/4"	6350	29.9	5300	25.2	4500	14.2	3450	11.0	2650	8.3
3/8"	3800	29.9	3200	25.2	2700	16.9	2050	13.0	1600	10.2
1/2"	3200	30.3	2250	25.6	1950	18.5	1500	14.2	1150	11.0
5/8"	2400	30.3	2000	25.2	1700	18.9	1300	14.2	1000	11.0
3/4"	1900	29.9	1600	24.0	1350	18.5	1050	13.8	800	10.2
Max cutting date										

- Please select high-precision machine and tool holder.
- Please use air blow or cutting liquid with high mist retardant property.
- Down milling is recommended in the case of side milling.
- When the machine rigidity and workpiece fixture stability is low, vibration and abnormal noise may be generated. Please reduce the rotating speed and feed speed stated above correspondingly.
- Make overhang of tool as short as possible in conditions of non-interference.

GM-4W — slot cutting

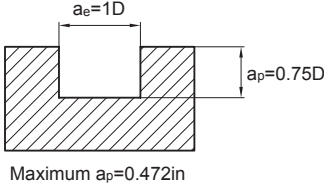
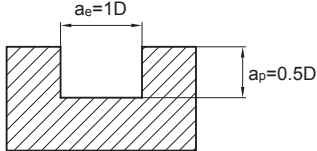
Workpiece material	Cast iron, Nodular cast iron		Carbon steel, Alloy steel ~750N/mm2		Carbon steel, Alloy steel ~30HRC		Pre-hardened steel, quenched and tempered steel ~40HRC		Stainless steel		
Cutting speed	260-350SFPM		230-330SFPM		200-300SFPM		130-230SFPM		100-200SFPM		
Cutting edge diameter of end mills (inch)	Rotating speed (r/min)	Feed speed (in/min)	Rotating speed (r/min)	Feed speed (in/min)	Rotating speed (r/min)	Feed speed (in/min)	Rotating speed (r/min)	Feed speed (in/min)	Rotating speed (r/min)	Feed speed (in/min)	
1/4"	5300	25.2	4500	21.3	3700	11.8	2900	9.1	2400	7.5	
3/8"	3200	25.2	2200	21.3	2250	14.2	1750	11.0	1450	9.1	
1/2"	2650	25.2	2250	21.3	1850	14.6	1450	11.4	1200	9.4	
5/8"	2000	25.2	1700	21.3	1400	15.4	1100	12.2	900	9.8	
3/4"	1600	25.2	1350	20.1	1100	15.4	900	11.8	700	9.1	
Max cutting date											

- Please select high-precision machine and tool holder.
- Please use air blow or cutting liquid with high mist retardant property.
- When the machine rigidity and workpiece fixture stability is low, vibration and abnormal noise may be generated. Please reduce the rotating speed and feed speed stated above correspondingly.
- Make overhang of tool as short as possible in conditions of non-interference.

HMX-4E ★ HMX-4EL

Workpiece materials	Pre-hardened steel, Hardened steel 40~50HRC		Hardened steel 50~60HRC		Hardened steel 60~68HRC	
	Diameter (inch)	Rotating speed (r/min)	Feed speed (in/z)	Rotating speed (r/min)	Feed speed (in/z)	Rotating speed (r/min)
1/32"	40000	0.00009	40000	0.00008	40000	0.00063
3/64"	40000	0.00014	40000	0.00012	40000	0.00094
1/16"	40000	0.00019	40000	0.00016	30000	0.00125
5/64"	40000	0.00023	3200	0.00020	24000	0.00156
3/32"	40000	0.00028	26700	0.00023	20000	0.00188
7/64"	34000	0.00033	22900	0.00027	17000	0.00219
1/8"	30000	0.00038	20000	0.00031	15000	0.00250
9/64"	26700	0.00042	17800	0.00035	13000	0.00281
5/32"	24000	0.00047	16000	0.00039	12000	0.00313
11/64"	21800	0.00052	14500	0.00043	10900	0.00344
3/16"	20000	0.00056	13300	0.00047	10000	0.00375
13/64"	18500	0.00061	12300	0.00051	9200	0.00406
7/32"	17200	0.00066	11400	0.00055	8600	0.00438
15/64"	16000	0.00070	10700	0.00059	8000	0.00469
1/4"	15000	0.00075	10000	0.00063	7500	0.00500
17/64"	14000	0.00080	9400	0.00066	7000	0.00531
9/32"	13400	0.00084	8900	0.00070	6600	0.00563
19/64"	12700	0.00089	8400	0.00074	6300	0.00594
5/16"	12000	0.00094	8000	0.00078	6000	0.00625
21/64"	11500	0.00098	7600	0.00082	5700	0.00656
11/32"	11000	0.00103	7300	0.00086	5400	0.00688
23/64"	10500	0.00108	7000	0.00090	5200	0.00719
3/8 "	10000	0.00113	6600	0.00094	5000	0.00750
25/64"	9600	0.00117	6400	0.00098	4800	0.00781
13/32"	9200	0.00122	6100	0.00102	4600	0.00813
27/64"	8900	0.00127	5900	0.00105	4400	0.00844
7/16"	8600	0.00131	5700	0.00109	4300	0.00875
29/64"	8300	0.00136	5500	0.00113	4100	0.00906
15/32"	8000	0.00141	5300	0.00117	4000	0.00938
31/64"	7800	0.00145	5100	0.00121	3800	0.00969
1/2 "	7500	0.00150	5000	0.00125	3700	0.01000
9/16"	6700	0.00169	4400	0.00141	3300	0.01125
5/8 "	6000	0.00188	4000	0.00156	3000	0.01250
11/16"	5500	0.00206	3600	0.00172	2700	0.01375
3/4 "	5000	0.00225	3300	0.00188	2500	0.01500
7/8 "	4300	0.00263	2800	0.00219	2100	0.01750
1"	3800	0.00300	2500	0.00250	1800	0.02000

E

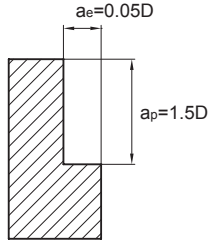
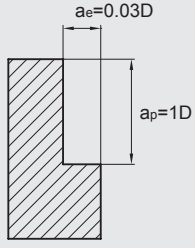
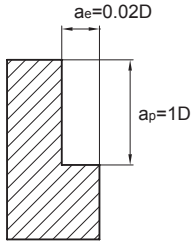
Workpiece material	Pre-hardened steel, Hardened steel 40~50HRC	Hardened steel 50~60HRC	Hardened steel 60~68HRC
Maximum cutting depth	 <p>Maximum $a_e = 1.0\text{mm}$</p>	 <p>Maximum $a_e = 0.5\text{mm}$</p>	 <p>Maximum $a_e = 0.3\text{mm}$</p>

- Please select high-precision and rigidity machine and tool holder.
- When the machine rigidity and workpiece fixture stability is low, vibration and abnormal noise may be generated. Please reduce the rotating speed and feed speed stated above correspondingly.
- Please use air blow or MQL (minimum oil mist cooling).
- Down milling is recommended in the case of side milling.
- Make overhang of tool as short as possible in conditions of non-interference.

HMX-2B ★ HMX-2BL

Workpiece material	Pre-hardened steel, Hardened steel 40~50HRC		Hardened steel 50~60HRC		Hardened steel 60~68HRC	
	Rotating speed (r/min)	Feed speed (in/z)	Rotating speed (r/min)	Feed speed (in/z)	Rotating speed (r/min)	Feed speed (in/z)
1/32"	40000	0.00031	40000	0.00028	40000	0.00025
3/64"	40000	0.00047	40000	0.00042	40000	0.00038
1/16"	40000	0.00063	40000	0.00056	40000	0.00050
5/64"	40000	0.00078	40000	0.00070	3200	0.00063
3/32"	40000	0.00094	33000	0.00084	26700	0.00075
7/64"	34000	0.00109	28000	0.00098	22900	0.00088
1/8"	30000	0.00125	25000	0.00113	20000	0.00100
9/64"	26700	0.00141	22000	0.00127	17800	0.00113
5/32"	24000	0.00156	20000	0.00141	16000	0.00125
11/64"	21800	0.00172	18000	0.00155	14500	0.00138
3/16"	20000	0.00188	16600	0.00169	13300	0.00150
13/64"	18500	0.00203	15400	0.00183	12300	0.00163
7/32"	17200	0.00219	14300	0.00197	11400	0.00175
15/64"	16000	0.00234	13300	0.00211	10700	0.00188
1/4"	15000	0.00250	12500	0.00225	10000	0.00200
17/64"	14000	0.00266	11600	0.00239	9400	0.00213
9/32"	13400	0.00281	11100	0.00253	8900	0.00225
19/64"	12700	0.00297	10500	0.00267	8400	0.00238
5/16"	12000	0.00313	10000	0.00281	8000	0.00250
21/64"	11500	0.00328	9500	0.00295	7600	0.00263
11/32"	11000	0.00344	9100	0.00309	7300	0.00275
23/64"	10500	0.00359	8750	0.00323	7000	0.00288
3/8"	10000	0.00375	8300	0.00338	6600	0.00300
25/64"	9600	0.00391	8000	0.00352	6400	0.00313
13/32"	9200	0.00406	7600	0.00366	6100	0.00325
27/64"	8900	0.00422	7400	0.00380	5900	0.00338
7/16"	8600	0.00438	7100	0.00394	5700	0.00350
29/64"	8300	0.00453	6900	0.00408	5500	0.00363
15/32"	8000	0.00469	6600	0.00422	5300	0.00375
31/64"	7800	0.00484	6500	0.00436	5100	0.00388
1/2"	7500	0.00500	6250	0.00450	5000	0.00400
9/16"	6700	0.00563	5500	0.00506	4400	0.00450
5/8"	6000	0.00625	5000	0.00563	4000	0.00500
11/16"	5500	0.00688	4500	0.00619	3600	0.00550
3/4"	5000	0.00750	4100	0.00675	3300	0.00600
7/8"	4300	0.00875	3500	0.00788	2800	0.00700
1"	3800	0.01000	3100	0.00900	2500	0.00800

Workpiece material	Pre-hardened steel, Hardened steel 40~50HRC	Hardened steel 50~60HRC	Hardened steel 60~68HRC
Maximum cutting depth			

- Please select high-precision and rigidity machine and tool holder.
- Above table shows the standard for operations with little change of machining load, such as contour machining. When the machine rigidity and workpiece fixture stability is low, vibration and abnormal noise may be generated. Please reduce the rotating speed and feed speed stated above correspondingly.
- Please use air blow or MQL (minimum oil mist cooling).
- When inclination angle α is more than 15° , please reduce rotating speed and feed speed to 50%~80% of the speeds stated in the table.
- Make overhang of tool as short as possible in conditions of non-interference.

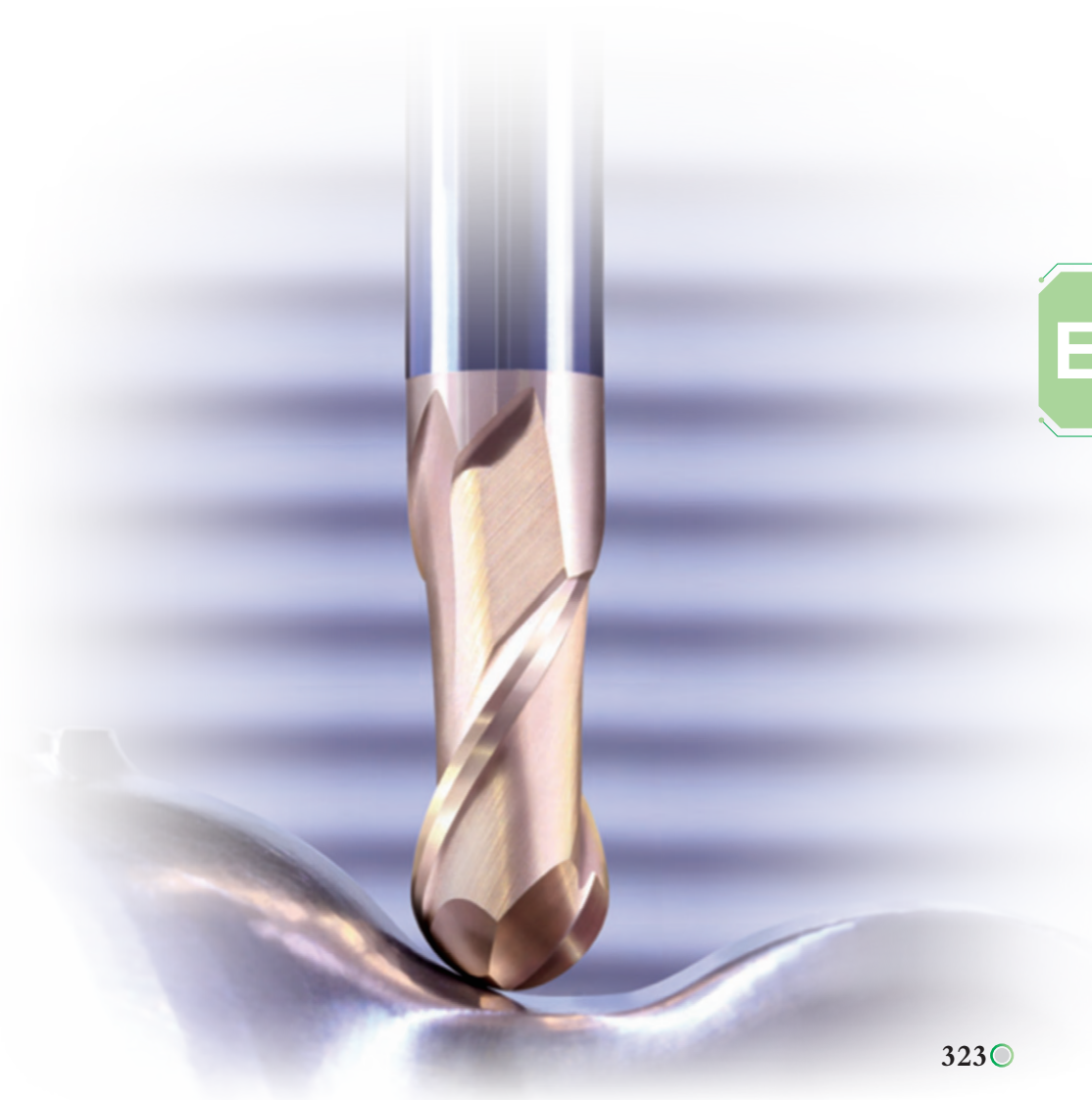

Cutting data of AL series flattened end mills

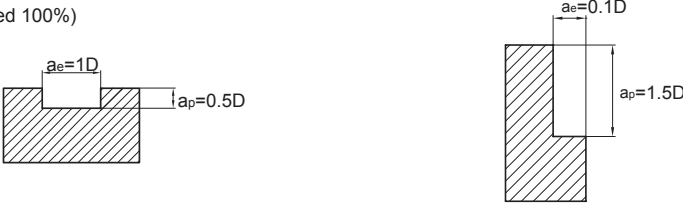
Workpiece materials	Aluminum alloy		Silicon aluminum alloy si≤10%	
	Rotation speed (r/min)	Feed (in/z)	Rotation speed (r/min)	Feed (in/z)
Cutting edge diameter (inch)				
1/16"	50000	0.00016	30000	0.00016
3/32"	33000	0.00024	20000	0.00024
1/8"	25000	0.00032	15000	0.00032
5/32"	20000	0.00048	12000	0.00048
3/16"	16600	0.00064	10000	0.00064
7/32"	14200	0.0008	8500	0.0008
1/4"	12400	0.00096	7500	0.00096
9/32"	11000	0.00112	6600	0.00112
5/16"	10000	0.0012	6000	0.0012
3/8"	8300	0.0016	5000	0.0016
7/16"	7100	0.002	4300	0.002
1/2"	6200	0.0022	3700	0.0022
9/16"	5500	0.0024	3300	0.0024
Max cutting date	<p>Maximum stock removal in milling grooves (Feed speed 100%)</p> 			

- The above table shows the reference value of side milling. The feed speed in slot milling is 70% of the reference value stated in the table.
- Please select high rigidity and precision machine and tool holder. Vibration and abnormal noise may be generated if the machine rigidity and workpiece fixture stability is low. Please reduce the rotating speed and feed speed stated above correspondingly.
- It is possible to increase the rotating speed and feed speed correspondingly if the cutting depth is low.
- Please use water-soluble cutting liquid.
- Down milling is recommended in the case of side milling.
- Make overhang of tool as short as possible in conditions of non-interference.

Cutting data of AL series ball nose end mills

Workpiece materials	Aluminum alloy		Silicon aluminum alloy si≤10%	
	Rotation speed (r/min)	Feed (in/z)	Rotation speed (r/min)	Feed (in/z)
1/8"	25000	0.0024	20000	0.002
3/16"	17000	0.004	13000	0.0032
1/4"	12500	0.0048	10000	0.004
5/16"	10000	0.0064	8000	0.0056
1/2"	6200	0.01	5000	0.008
5/8"	5000	0.0128	4000	0.01
3/4"	4200	0.016	3400	0.0128
Max cutting data				

- Please select high rigidity and precision machine and tool holder. Vibration and abnormal noise may be generated if the machine rigidity and workpiece fixture stability is low. Please reduce the rotating speed and feed speed stated above correspondingly.
- If the cutting depth is low, it is possible to increase the rotating speed and feed speed correspondingly.
- Please use water-soluble cutting liquid.
- Make overhang of tool as short as possible in conditions of non-interference.

AL-2R-AIR

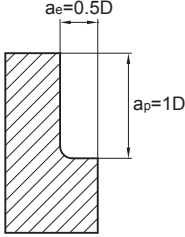
Workpiece material	Aluminum alloy		Silicon aluminum alloy Si≤10%	
Cutting speed	1650-2600SFPM		1650-2600SFPM	
Cutting edge diameter (inch)	Rotation speed (r/min)	Feed speed (in/min)	Rotation speed (r/min)	Feed speed (in/min)
1/2"	18000	169.291	18000	169.291
5/8"	15000	188.976	15000	188.976
3/4"	12000	216.535	12000	216.535
Maximum cutting depth	 <p>The diagram illustrates the maximum cutting depth parameters for the end mill. It shows a cross-section of a workpiece being machined. The cutting edge diameter is labeled as $a_e = 0.5D$, where D is the diameter of the end mill. The maximum cutting depth is labeled as $a_p = 1D$, where D is the diameter of the end mill.</p>			

- This cutting condition is only used on the specific CNC machine for high speed aluminum alloy machining.
- Please ensure on using air blow or cutting liquid for chips evacuation.
- Caution on fire-The sparks on machining and heating of wears may cause the flammability and fire.
- The measurement of rotation balance is compulsory before the machining.

Cutting data of UM series flattened end mills

Workpiece material	Carbon steel, Alloy steel		Stainless steel		Heat resistant alloy, Ti alloy	
	Rotating speed (r/min)	Feed speed (in/min)	Rotating speed (r/min)	Feed speed (in/min)	Rotating speed (r/min)	Feed speed (in/min)
5/32"	19900	78.35	15920	62.59	11940	47.05
3/16"	15920	68.89	12730	55.11	9550	37.4
15/64"	13260	66.92	10600	53.54	7960	36.61
5/16"	9950	66.14	7960	52.76	5970	36.61
25/64"	7960	65.35	6370	52.36	4775	35.83
15/32"	6630	65.35	5300	52.36	3980	35.83
9/16"	5685	61.02	4550	48.82	3410	33.46
5/8"	4975	61.02	3980	48.82	2985	33.46
25/32"	3980	61.02	3180	48.82	2390	33.46
Maximum cutting depth						

- The above table shows the standard value of side milling. When milling slot, rotating speed is around 80%~100% of the stated value, and feed speed around 60%~80%.
- Non water-soluble cutting liquid is recommended in machining of stainless steel heat-resistant alloy and Ti alloy.
- Please select high rigid and precise machine and tool holder.
- Adjust rotating speed and feed speed according to cutting depth and machine rigidity.
- Down milling is recommended in the case of side milling.
- Make overhang of tool as short as possible in conditions of non-interference.



VSM-4E ★ VSM-4EFP

Workpiece material	Carbon steel, Alloy steel		Stainless steel		Heat resistant alloy, Ti alloy	
	Rotating speed (r/min)	Feed speed (in/min)	Rotating speed (r/min)	Feed speed (in/min)	Rotating speed (r/min)	Feed speed (in/min)
1/4"	5300	29.53	2700	7.87	2470	4.72
3/8"	3100	25.20	1600	8.27	1430	5.12
1/2"	2600	23.62	1300	6.69	1235	4.33
5/8"	1900	20.47	1000	5.91	935	3.54
3/4"	1500	17.52	800	5.51	740	3.54
1"	1250	15.75	600	4.72	550	3.15

Maximum cutting depth		
-----------------------	--	--

- Above table shows the standard value of side milling. When milling slot, 80%~100% of rotating speed and 60%~80% of feed speed stated above are recommended as standard.
- When cutting stainless steel, titanium alloy and heat resistant alloy, non- water soluble cutting fluid is recommended.
- Please select high rigidity, high precision machine tools and tool holders.
- Adjust machine's rigidity speed and feed rate based on the depth of cut and machine's rigidity.
- Climb milling recommended.
- Make overhang of the tool as short as possible under the conditions of non-interference.
- Table above is based on the recommended value of $L/D \leq 4$. When $L/D > 4$, reduce both rotating and feed speed down to 70%.

VSM-4RFP

Workpiece material	Carbon steel, Alloy steel		Stainless steel		Heat resistant alloy, Ti alloy	
	Rotating speed (r/min)	Feed speed (in/min)	Rotating speed (r/min)	Feed speed (in/min)	Rotating speed (r/min)	Feed speed (in/min)
1/4"	5300	35.43	2700	9.45	2470	5.71
3/8"	3100	30.31	1600	10.04	1430	6.10
1/2"	2600	28.35	1300	8.07	1235	5.31
5/8"	1900	24.61	1000	7.09	935	4.33
Maximum cutting depth						

- Above table shows the standard value of side milling. When milling slot, 80%~100% of rotating speed and 60%~80% of feed speed stated above are recommended as standard.
- When cutting stainless steel, titanium alloy and heat resistant alloy, non- water soluble cutting fluid is recommended.
- Please select high rigidity, high precision machine tools and tool holders.
- Adjust machine's rigidity speed and feed rate based on the depth of cut and machine's rigidity.
- Climb milling recommended.
- Make overhang of the tool as short as possible under the conditions of non-interference.
- Table above is based on the recommended value of $L/D \leq 4$. When $L/D > 4$, reduce both rotating and feed speed down to 70%.

Boring Tools





ZDD03-320-XP32-SP09-02
40031912
160M



GD series

*Universal-purpose
twist drill*

Boring tools

Drills	P330-393
Drilling tools overview	P334
Solid carbide drills	P330-381
Solid carbide drills code key	P335
GD series drills	P336-366
SL series drills	P367-376
Technical information for solid carbide drills	P377-381
Indexable shallow drills	P382-393
Shallow drills code key	P383
Shallow drills overview	P384-391
Shallow drilling inserts overview	P392
Recommended cutting parameters for shallow drills	P393

GD series universal machining

GD03 ▶ P338-366



GD03C ▶ P338-366



GD05 ▶ P338-366



GD05C ▶ P338-366



GD08C ▶ P338-366



SL series deep hole machining

1588SL ▶ P371-376



Indexable shallow drills

ZTD03/04/05 ▶ P386-391



Solid carbide drills code key

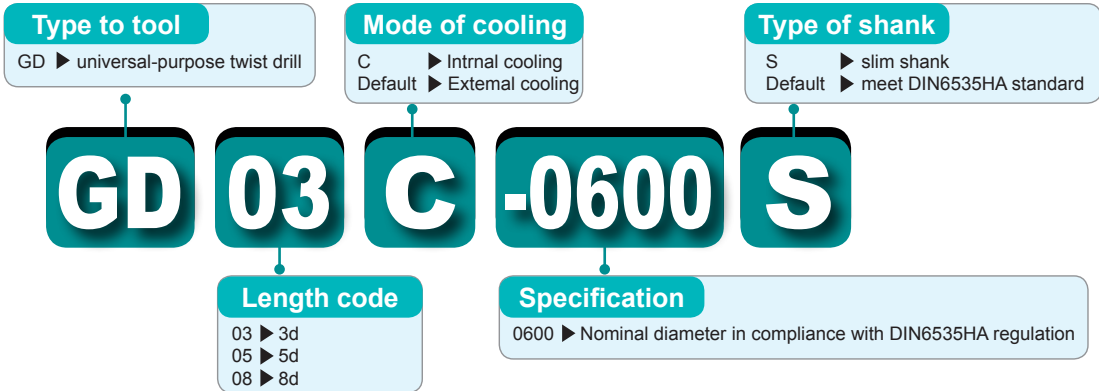

Code	Description
1	As per DIN338
2	As per DIN1897
3	As per QJ/ZZQ(TO)01.001.002
4	As per DIN6537K
5	As per DIN6537K
6	As per DIN6537K
7	As per the rule ZZC-C in QJ/ZZQ(TO)01.001.002
8	As per the rule ZZC-D in QJ/ZZQ(TO)01.001.002
9	As per the rule ZZC-E in QJ/ZZQ(TO)01.001.002

Length code

Code	Description
SL	Deep twist drills
ST	Twist drill for soft steel, stainless steel
PC	Straight flute drill for aluminum, cast iron

Geometry

Code	Description
1	Drills

Type to tool

Code	Description
C	Internal coolant
Default	External coolant

Mode of cooling



Code	Description
1	Straight shank
2	Square head straight shank as per DIN10
3	Double flattened straight shank as per DIN1809
5	Straight shank as per DIN6535HA
7	Whistle notch shank as per DIN6535HE
9	Tapered shank

Type of shank

Code	Description
0	Twist drill
3	Multiple functions twist drill
4	Centering drill
5	Step drill
7	Straight flute drill
8	Deep drill

Type of drill

Code	Description
0850	Nominal diameter of drill

Specification

Identification of drilling depth			
Cutting depth shown when the tool is non-pilot drill		Point angle identification shown when tool is pilot drill	
Code	Description	Code	Description
03	(2~3) d	90	pilot drill with 90° point angle
05	(4~5) d		
08	(7~8) d	120	pilot drill with 120° point angle
12	(12) d		
15	(15) d		
20	(20) d		
30	(30) d		



GD series Universal-purpose

Application range

Versatile, for high efficiency machining in a variety of material e.g. P(steel), M(stainless steel), K (Cast iron).



- Linear cutting edge with high strength.
Optimized drill point structure for better cutting performance.

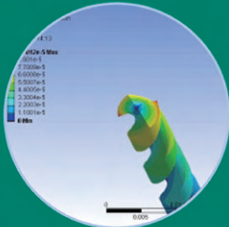

- Simulation in combination with testing for superior overall performance.



- Double edge-line design for improved machining stability.



- Professional after treatment for coating ensures low-resistance high-efficiency machining.



Long and stable tool life

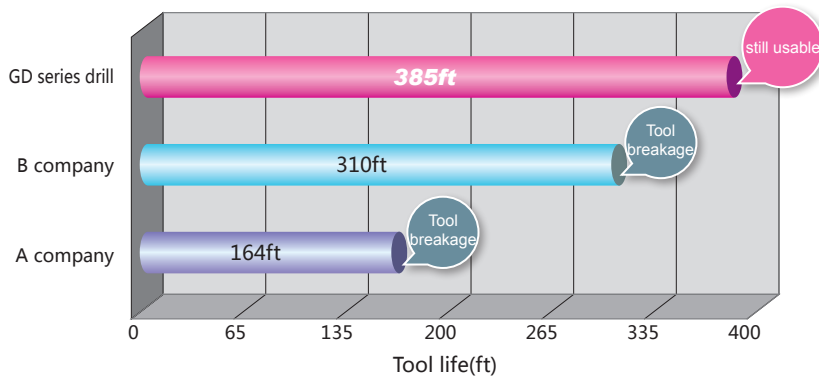

tool: GD05C-0560
 workpiece material: P20 mod.
 $V_c=320\text{SFPM}$; $f_r=0.0059\text{in/r}$; $H=1.063\text{in}$
 cooling system: water soluble cooling

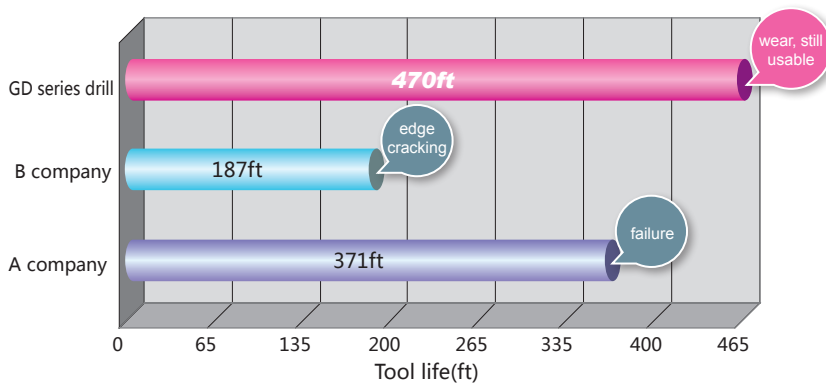

tool: GD05C-1000
 workpiece material: 1045
 $V_c=490\text{SFPM}$; $f_r=0.0098\text{in/r}$; $H=1.575\text{in}$
 cooling system: water soluble cooling

outstanding machining precision

quality of hole wall:

tool: GD03C-0820
 workpiece material: P20 mod.
 $V_c=380\text{SFPM}$; $f_r=0.0091\text{in/r}$; $H=1.181\text{in}$
 cooling system: water soluble cooling

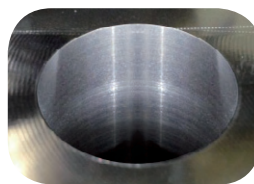

GD series drill



A company

excellent chip breaking performance

chip breaking performance:

tool: GD05C-0600
 workpiece material: 321
 $V_c=240\text{SFPM}$; $f_r=0.0079\text{in/r}$; $H=1.181\text{in}$
 cooling system: water soluble cooling



GD series drill



A company

GD series universal machining

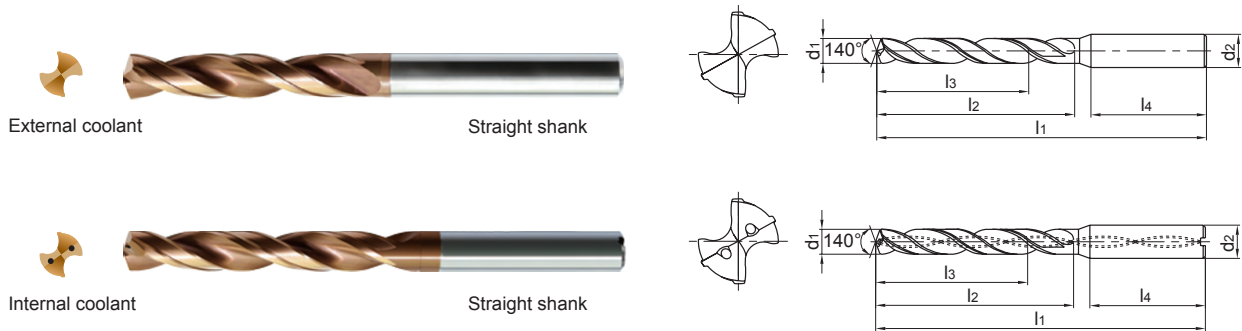

● Suitable for high efficiency drilling in a variety of materials e.g steel, stainless steel, cast iron.

Drill diameter d ₁ (m ₇)			Drilling depth (l/d)	Cooling mode	Shank type	Type	Basic dimension(mm)					Suitable for thread		Grade
mm	inch	Fraction					Shank diameter d ₂ (h ₆)	Overall length l ₁	Flute length l ₂	Recommended drilling depth l ₃	Shank length l ₄	cutting taps / tread milling cutters	forming taps	
2.0	0.0787	--	3	External coolant	Straight shank	GD03-0200	4	58	13	9	28		NO.2-64UNF	●
	0.0787	--	5			GD05-0200	4	58	18	14	28			●
2.1	0.0827	--	3			GD03-0210	4	58	13	9	28	NO.3-48UNC	●	
	0.0827	--	5			GD05-0210	4	58	18	14	28		●	
2.15	0.0846	--	3			GD03-0215	4	58	13	9	28	NO.3-56UNF	●	
	0.0846	--	5			GD05-0215	4	58	18	14	28		●	
2.2	0.0866	--	3			GD03-0220	4	58	13	9	28		●	
	0.0866	--	5			GD05-0220	4	58	18	14	28		●	
2.3	0.0906	--	3			GD03-0230	4	58	13	9	28	M2.5×0.45	●	
	0.0906	--	5			GD05-0230	4	58	18	14	28		NO.3-56UNF	●
2.35	0.0925	--	3			GD03-0235	4	58	17	12	28	NO.4-40UNC	●	
	0.0925	--	5			GD05-0235	4	58	22	17	28		●	
2.4	0.0945	--	3			GD03-0240	4	58	17	12	28	NO.4-48UNF	●	
	0.0945	--	5			GD05-0240	4	58	22	17	28		●	
2.5	0.0984	--	3			GD03-0250	4	58	17	12	28	M3×0.5	●	
	0.0984	--	5			GD05-0250	4	58	22	17	28		●	
2.55	0.1004	--	3			GD03-0255	4	58	17	12	28	NO.4-40UNC	●	
	0.1004	--	5			GD05-0255	4	58	22	17	28		●	
2.6	0.1024	--	3			GD03-0260	4	58	17	12	28	NO.4-48UNF	●	
	0.1024	--	5			GD05-0260	4	58	22	17	28		●	
2.65	0.1043	--	3			GD03-0265	4	58	17	12	28	NO.5-40UNC	●	
	0.1043	--	5			GD05-0265	4	58	22	17	28		●	
2.7	0.1063	--	3			GD03-0270	4	58	17	12	28	NO.5-44UNF	●	
	0.1063	--	5			GD05-0270	4	58	22	17	28		●	
2.8	0.1102	--	3	GD03-0280	4	58	17	12	28	M3×0.5	●			
	0.1102	--	5	GD05-0280	4	58	22	17	28		●			
2.85	0.1122	--	3	GD03-0285	4	58	17	12	28	NO.6-32UNC	●			
	0.1122	--	5	GD05-0285	4	58	22	17	28		●			
2.9	0.1142	--	3	GD03-0290	4	58	17	12	28	NO.5-40UNC	●			
	0.1142	--	5	GD05-0290	4	58	22	17	28		NO.5-44UNF	●		

● Stock available ○ Make-to-order

Drill diameter d ₁ (mm)			Drilling depth (l/d)	Cooling mode	Shank type	Type	Basic dimension(mm)					Suitable for thread		Grade
mm	inch	Fraction					Shank diameter	Overall length	Flute length	Recommended drilling depth	Shank length	cutting taps / tread milling cutters	forming taps	
									l ₃	l ₄			KDG3013	
						d ₂ (h ₆)	l ₁	l ₂	l ₃	l ₄				
2.95	0.1161	--	3	External coolant	Straight shank	GD03-0295	4	58	17	12	28	NO.6-40UNF	●	
	0.1161	--	5			GD05-0295	4	58	22	17	28		●	
3.0	0.1181	--	3	External coolant		GD03-0300	6	62	20	14	36	NO.6-40UNF	●	
	0.1181	--	5			GD05-0300	6	66	28	23	36		●	
	0.1181	--	3	Internal coolant		GD03C-0300	6	62	20	14	36		●	
	0.1181	--	5			GD05C-0300	6	66	28	23	36		●	
	0.1181	--	8			GD08C-0300	6	72	34	29	36		○	
	0.1220	--	3			External coolant	GD03-0310S	4	62	20	14		36	●
0.1220	--	5	GD05-0310S	4			66	28	23	36	●			
3.1	0.1220	--	3	Internal coolant		GD03C-0310S	4	62	20	14	36	NO.6-40UNF	●	
	0.1220	--	5			GD05C-0310S	4	66	28	23	36		●	
	0.1220	--	3	External coolant		GD03-0310	6	62	20	14	36		○	
	0.1220	--	5			GD05-0310	6	66	28	23	36		○	
	0.1220	--	3	Internal coolant		GD03C-0310	6	62	20	14	36		○	
	0.1220	--	5			GD05C-0310	6	66	28	23	36		○	
	0.1220	--	8			GD08C-0310	6	72	34	29	36		○	
	0.1250	1/8	3		External coolant	GD03-03175S	4	62	20	14	36		NO.6-40UNF	●
0.1250	1/8	5	GD05-03175S	4		66	28	23	36	●				
3.175	0.1250	1/8	3	Internal coolant	GD03C-03175S	4	62	20	14	36	●			
	0.1250	1/8	5		GD05C-03175S	4	66	28	23	36	●			
	0.1250	1/8	3	External coolant	GD03-03175	6	62	20	14	36	○			
	0.1250	1/8	5		GD05-03175	6	66	28	23	36	○			
	0.1250	1/8	3	Internal coolant	GD03C-03175	6	62	20	14	36	○			
	0.1250	1/8	5		GD05C-03175	6	66	28	23	36	○			
	0.1260	--	3		External coolant	GD03-0320S	4	62	20	14	36	NO.6-40UNF	●	
	0.1260	--	5			GD05-0320S	4	66	28	23	36		●	
3.2	0.1260	--	3	Internal coolant	GD03C-0320S	4	62	20	14	36	●			
	0.1260	--	5		GD05C-0320S	4	66	28	23	36	●			
	0.1260	--	3	External coolant	GD03-0320	6	62	20	14	36	○			
	0.1260	--	5		GD05-0320	6	66	28	23	36	○			
	0.1260	--	3	Internal coolant	GD03C-0320	6	62	20	14	36	○			
	0.1260	--	5		GD05C-0320	6	66	28	23	36	○			
	0.1260	--	8		GD08C-0320	6	72	34	29	36	○			

Note: For drilling depth (l/d) of 8 ,namely GD08C series, tolerance of shank diameter is h₈.

● Stock available ○ Make-to-order

▶ Applicable material table

◎ Very suitable ○ Suitable

Grade	Workpiece material										
	Mild steel HB ≤ 180	Carbon steel, Alloy steel	Pre-hardened steel, Hardened steel			Stainless steel	Cast iron	Nodular cast iron	Aluminum alloy	Copper alloy	Heat resistant alloy
			~40HRC	~50HRC	~60HRC						
KDG3013	○	◎	◎			○	◎	◎			○

GD series universal machining

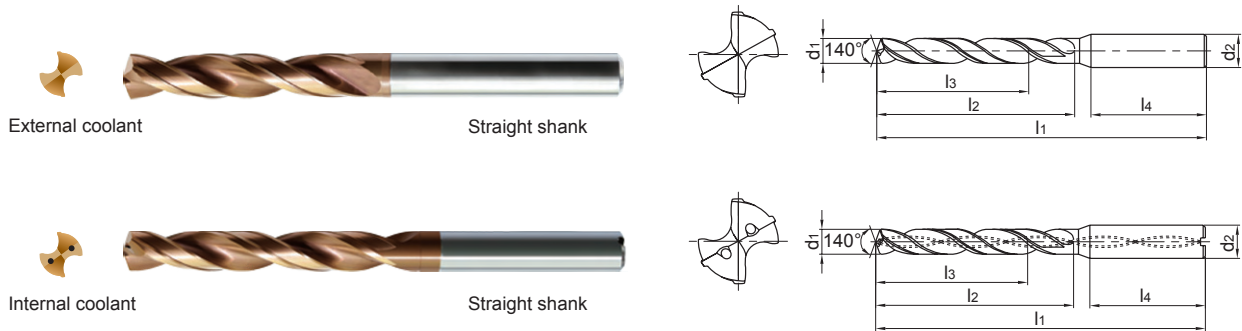

● Suitable for high efficiency drilling in a variety of materials e.g steel, stainless steel, cast iron.

Drill diameter d ₁ (m ₇)			Drilling depth (l/d)	Cooling mode	Shank type	Type	Basic dimension(mm)					Suitable for thread		Grade	
mm	inch	Fraction					Shank diameter	Overall length	Flute length	Recommended drilling depth	Shank length	cutting taps / tread milling cutters	forming taps		
									d ₂ (h ₆)	l ₁	l ₂	l ₃	l ₄		
3.25	0.1280	--	3	External coolant	Straight shank	GD03-0325S	4	62	20	14	36	M4×0.7		●	
	0.1280	--	5			GD05-0325S	4	66	28	23	36			●	
	0.1280	--	3	Internal coolant		GD03C-0325S	4	62	20	14	36			●	
	0.1280	--	5			GD05C-0325S	4	66	28	23	36			●	
	0.1280	--	3	External coolant		GD03-0325	6	62	20	14	36			○	
	0.1280	--	5			GD05-0325	6	66	28	23	36			○	
	0.1280	--	3	Internal coolant		GD03C-0325	6	62	20	14	36			○	
	0.1280	--	5			GD05C-0325	6	66	28	23	36			○	
3.3	0.1299	--	3	External coolant	GD03-0330S	4	62	20	14	36	M4×0.7		●		
	0.1299	--	5		GD05-0330S	4	66	28	23	36			●		
	0.1299	--	3	Internal coolant	GD03C-0330S	4	62	20	14	36			●		
	0.1299	--	5		GD05C-0330S	4	66	28	23	36			●		
	0.1299	--	3	External coolant	GD03-0330	6	62	20	14	36			○		
	0.1299	--	5		GD05-0330	6	66	28	23	36			○		
	0.1299	--	3	Internal coolant	GD03C-0330	6	62	20	14	36			○		
	0.1299	--	5		GD05C-0330	6	66	28	23	36			○		
3.4	0.1339	--	3	External coolant	GD03-0340S	4	62	20	14	36	M4×0.5	NO.8-32UNC NO.8-36UNF	●		
	0.1339	--	5		GD05-0340S	4	66	28	23	36			●		
	0.1339	--	3	Internal coolant	GD03C-0340S	4	62	20	14	36			●		
	0.1339	--	5		GD05C-0340S	4	66	28	23	36			●		
	0.1339	--	3	External coolant	GD03-0340	6	62	20	14	36			○		
	0.1339	--	5		GD05-0340	6	66	28	23	36			○		
	0.1339	--	3	Internal coolant	GD03C-0340	6	62	20	14	36			○		
	0.1339	--	5		GD05C-0340	6	66	28	23	36			○		
3.5	0.1378	--	3	External coolant	GD03-0350S	4	62	20	14	36	M4×0.5 NO.8-32UNC NO.8-36UNF		●		
	0.1378	--	5		GD05-0350S	4	66	28	23	36			●		
	0.1378	--	3	Internal coolant	GD03C-0350S	4	62	20	14	36			●		
	0.1378	--	5		GD05C-0350S	4	66	28	23	36			●		

● Stock available ○ Make-to-order

Drill diameter d ₁ (m ₇)			Drilling depth (l/d)	Cooling mode	Shank type	Type	Basic dimension(mm)					Suitable for thread		Grade	
mm	inch	Fraction					Shank diameter d ₂ (h ₆)	Overall length l ₁	Flute length l ₂	Recommended drilling depth l ₃	Shank length l ₄	cutting taps / tread milling cutters	forming taps		
3.5	0.1378	--	3	External coolant	Straight shank	GD03-0350	6	62	20	14	36	M4×0.5		○	
	0.1378	--	5			GD05-0350	6	66	28	23	36			○	
	0.1378	--	3	Internal coolant		GD03C-0350	6	62	20	14	36			NO.8-32UNC	○
	0.1378	--	5			GD05C-0350	6	66	28	23	36				○
	0.1378	--	8			GD08C-0350	6	72	34	29	36				○
3.6	0.1417	--	3	External coolant		GD03-0360S	4	62	20	14	36	M4×0.7		●	
	0.1417	--	5			GD05-0360S	4	66	28	23	36			●	
	0.1417	--	3	Internal coolant		GD03C-0360S	4	62	20	14	36			●	
	0.1417	--	5			GD05C-0360S	4	66	28	23	36			●	
	0.1417	--	3			External coolant	GD03-0360	6	62	20	14			36	○
	0.1417	--	5	GD05-0360	6		66	28	23	36	○				
	0.1417	--	3	Internal coolant	GD03C-0360	6	62	20	14	36	○				
	0.1417	--	5		GD05C-0360	6	66	28	23	36	○				
	0.1417	--	8		GD08C-0360	6	72	34	29	36	○				
	3.7	0.1457	--	3	External coolant	GD03-0370S	4	62	20	14	36			M4×0.5	
0.1457		--	5	GD05-0370S		4	66	28	23	36	●				
0.1457		--	3	Internal coolant	GD03C-0370S	4	62	20	14	36	●				
0.1457		--	5		GD05C-0370S	4	66	28	23	36	●				
0.1457		--	3		External coolant	GD03-0370	6	62	20	14	36	○			
0.1457		--	5	GD05-0370		6	66	28	23	36	○				
0.1457		--	3	Internal coolant	GD03C-0370	6	62	20	14	36	○				
0.1457		--	5		GD05C-0370	6	66	28	23	36	○				
0.1457		--	8		GD08C-0370	6	72	34	29	36	○				
3.8	0.1496	--	3	External coolant	GD03-0380S	4	66	24	17	36	M4×0.5 NO.8-32UNC		●		
	0.1496	--	5		GD05-0380S	4	74	36	29	36			●		
	0.1496	--	3	Internal coolant	GD03C-0380S	4	66	24	17	36			●		
	0.1496	--	5		GD05C-0380S	4	74	36	29	36			●		
	0.1496	--	3		External coolant	GD03-0380	6	66	24	17			36	○	
	0.1496	--	5	GD05-0380		6	74	36	29	36			○		
	0.1496	--	3	Internal coolant	GD03C-0380	6	66	24	17	36			○		
	0.1496	--	5		GD05C-0380	6	74	36	29	36			○		
	0.1496	--	8		GD08C-0380	6	81	43	36	36			○		

Note: For drilling depth (l/d) of 8, namely GD08C series, tolerance of shank diameter is h₈.

● Stock available ○ Make-to-order



▶ Applicable material table

◎ Very suitable ○ Suitable

Grade	Workpiece material										
	Mild steel HB ≤ 180	Carbon steel, Alloy steel	Pre-hardened steel, Hardened steel			Stainless steel	Cast iron	Nodular cast iron	Aluminum alloy	Copper alloy	Heat resistant alloy
			~40HRC	~50HRC	~60HRC						
KDG3013	○	◎	◎			○	◎	◎			○

GD series universal machining

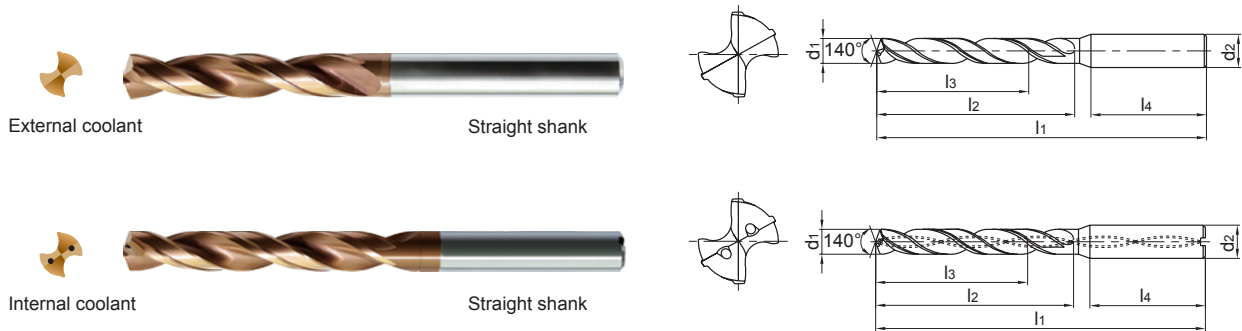

● Suitable for high efficiency drilling in a variety of materials e.g steel, stainless steel, cast iron.

Drill diameter d ₁ (m ₇)			Drilling depth (l/d)	Cooling mode	Shank type	Type	Basic dimension(mm)					Suitable for thread		Grade		
mm	inch	Fraction					Shank diameter	Overall length	Flute length	Recommended drilling depth	Shank length	cutting taps / tread milling cutters	forming taps		KDG3013	
									d ₂ (h ₆)	l ₁	l ₂	l ₃	l ₄			
3.85	0.1516	--	3	External coolant	Straight shank	GD03-0385S	4	66	24	17	36	NO.8-36UNF		●		
	0.1516	--	5			GD05-0385S	4	74	36	29	36			●		
	0.1516	--	3	Internal coolant		GD03C-0385S	4	66	24	17	36			●		
	0.1516	--	5			GD05C-0385S	4	74	36	29	36			●		
	0.1516	--	3	External coolant		GD03-0385	6	66	24	17	36			○		
	0.1516	--	5			GD05-0385	6	74	36	29	36			○		
	0.1516	--	3	Internal coolant		GD03C-0385	6	66	24	17	36			○		
	0.1516	--	5			GD05C-0385	6	74	36	29	36			○		
3.9	0.1535	--	3	External coolant	GD03-0390S	4	66	24	17	36	NO.10-24UNC		●			
	0.1535	--	5		GD05-0390S	4	74	36	29	36			●			
	0.1535	--	3	Internal coolant	GD03C-0390S	4	66	24	17	36			●			
	0.1535	--	5		GD05C-0390S	4	74	36	29	36			●			
	0.1535	--	3	External coolant	GD03-0390	6	66	24	17	36			○			
	0.1535	--	5		GD05-0390	6	74	36	29	36			○			
	0.1535	--	3	Internal coolant	GD03C-0390	6	66	24	17	36			○			
	0.1535	--	5		GD05C-0390	6	74	36	29	36			○			
	0.1535	--	8		GD08C-0390	6	81	43	36	36			○			
	3.97	0.1563	5/32	3	External coolant	GD03-03970S	4	66	24	17			36			●
0.1563		5/32	5	GD05-03970S		4	74	36	29	36	●					
0.1563		5/32	3	Internal coolant	GD03C-03970S	4	66	24	17	36	●					
0.1563		5/32	5		GD05C-03970S	4	74	36	29	36	●					
0.1563		5/32	3	External coolant	GD03-03970	6	66	24	17	36	○					
0.1563		5/32	5		GD05-03970	6	74	36	29	36	○					
0.1563		5/32	3	Internal coolant	GD03C-03970	6	66	24	17	36	○					
0.1563		5/32	5		GD05C-03970	6	74	36	29	36	○					
4.0	0.1575	--	3	External coolant	GD03-0400S	4	66	24	17	36			●			
	0.1575	--	5		GD05-0400S	4	74	36	29	36			●			
	0.1575	--	3	Internal coolant	GD03C-0400S	4	66	24	17	36			●			
	0.1575	--	5		GD05C-0400S	4	74	36	29	36			●			

● Stock available ○ Make-to-order

Drill diameter d ₁ (mm)			Drilling depth (l/d)	Cooling mode	Shank type	Type	Basic dimension(mm)					Suitable for thread		Grade		
mm	inch	Fraction					Shank diameter d ₂ (h ₆)	Overall length l ₁	Flute length l ₂	Recommended drilling depth l ₃	Shank length l ₄	cutting taps / tread milling cutters	forming taps			
4.0	0.1575	--	3	External coolant	Straight shank	GD03-0400	6	66	24	17	36	NO.10-32UNF		○		
	0.1575	--	5			GD05-0400	6	74	36	29	36			○		
	0.1575	--	3	Internal coolant		GD03C-0400	6	66	24	17	36			○		
	0.1575	--	5			GD05C-0400	6	74	36	29	36			○		
	0.1575	--	8			GD08C-0400	6	81	43	36	36			○		
4.1	0.1614	--	3	External coolant		GD03-0410	6	66	24	17	36			NO.10-32UNF		●
	0.1614	--	5			GD05-0410	6	74	36	29	36					●
	0.1614	--	3	Internal coolant		GD03C-0410	6	66	24	17	36					●
	0.1614	--	5			GD05C-0410	6	74	36	29	36					●
	0.1614	--	8			GD08C-0410	6	81	43	36	36					○
4.2	0.1654	--	3	External coolant	GD03-0420	6	66	24	17	36	M5×0.8		●			
	0.1654	--	5		GD05-0420	6	74	36	29	36			●			
	0.1654	--	3	Internal coolant	GD03C-0420	6	66	24	17	36			●			
	0.1654	--	5		GD05C-0420	6	74	36	29	36			●			
	0.1654	--	8		GD08C-0420	6	81	43	36	36			○			
4.3	0.1693	--	3	External coolant	GD03-0430	6	66	24	17	36					●	
	0.1693	--	5		GD05-0430	6	74	36	29	36					●	
	0.1693	--	3	Internal coolant	GD03C-0430	6	66	24	17	36					●	
	0.1693	--	5		GD05C-0430	6	74	36	29	36					●	
	0.1693	--	8		GD08C-0430	6	81	43	36	36					○	
4.35	0.1713	--	3	External coolant	GD03-0435	6	66	24	17	36	NO.10-24UNC				●	
	0.1713	--	5		GD05-0435	6	74	36	29	36					●	
	0.1713	--	3	Internal coolant	GD03C-0435	6	66	24	17	36					●	
	0.1713	--	5		GD05C-0435	6	74	36	29	36					●	
4.4	0.1732	--	3	External coolant	GD03-0440	6	66	24	17	36						
	0.1732	--	5		GD05-0440	6	74	36	29	36			●			
	0.1732	--	3	Internal coolant	GD03C-0440	6	66	24	17	36			●			
	0.1732	--	5		GD05C-0440	6	74	36	29	36			●			
	0.1732	--	8		GD08C-0440	6	81	43	36	36			○			
4.45	0.1752	--	3	External coolant	GD03-0445	6	66	24	17	36			NO.10-32UNF			
	0.1752	--	5		GD05-0445	6	74	36	29	36	●					
	0.1752	--	3	Internal coolant	GD03C-0445	6	66	24	17	36	●					
	0.1752	--	5		GD05C-0445	6	74	36	29	36	●					

Note: For drilling depth (l/d) of 8 ,namely GD08C series, tolerance of shank diameter is h₈.

● Stock available ○ Make-to-order

Applicable material table

◎ Very suitable ○ Suitable

Grade	Workpiece material									
	Mild steel HB ≤ 180	Carbon steel, Alloy steel	Pre-hardened steel, Hardened steel			Stainless steel	Cast iron	Nodular cast iron	Aluminum alloy	Copper alloy
KDG3013	○	◎	◎	◎	◎	○	◎	◎		○

GD series universal machining

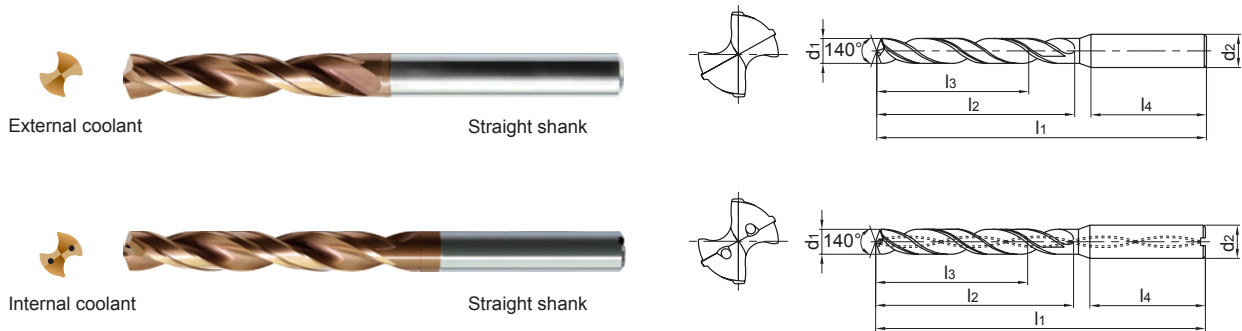

● Suitable for high efficiency drilling in a variety of materials e.g steel, stainless steel, cast iron.

Drill diameter d ₁ (m ₇)			Drilling depth (l/d)	Cooling mode	Shank type	Type	Basic dimension(mm)					Suitable for thread		Grade	
mm	inch	Fraction					Shank diameter	Overall length	Flute length	Recommended drilling depth	Shank length	cutting taps / tread milling cutters	forming taps		
									d ₂ (h ₆)	l ₁	l ₂	l ₃	l ₄		
4.5	0.1772	--	3	External coolant	Straight shank	GD03-0450	6	66	24	17	36	NO.12-24UNC		●	
	0.1772	--	5			GD05-0450	6	74	36	29	36			●	
	0.1772	--	3	Internal coolant		GD03C-0450	6	66	24	17	36			●	
	0.1772	--	5			GD05C-0450	6	74	36	29	36			●	
	0.1772	--	8			GD08C-0450	6	81	43	36	36			○	
4.6	0.1811	--	3	External coolant		GD03-0460	6	66	24	17	36			●	
	0.1811	--	5			GD05-0460	6	74	36	29	36			●	
	0.1811	--	3	Internal coolant		GD03C-0460	6	66	24	17	36			●	
	0.1811	--	5			GD05C-0460	6	74	36	29	36			●	
	0.1811	--	8			GD08C-0460	6	81	43	36	36			○	
4.65	0.1831	--	3	External coolant	GD03-0465	6	66	24	17	36		M5×0.8	●		
	0.1831	--	5		GD05-0465	6	74	36	29	36			●		
	0.1831	--	3	Internal coolant	GD03C-0465	6	66	24	17	36			●		
	0.1831	--	5		GD05C-0465	6	74	36	29	36			●		
4.7	0.1850	--	3	External coolant	GD03-0470	6	66	24	17	36	NO.12-28UNF		●		
	0.1850	--	5		GD05-0470	6	74	36	29	36			●		
	0.1850	--	3	Internal coolant	GD03C-0470	6	66	24	17	36			●		
	0.1850	--	5		GD05C-0470	6	74	36	29	36			●		
	0.1850	--	8		GD08C-0470	6	81	43	36	36			○		
4.763	0.1875	3/16	3	External coolant	GD03-04763	6	66	24	17	36			●		
	0.1875	3/16	5		GD05-04763	6	74	36	29	36			●		
	0.1875	3/16	3	Internal coolant	GD03C-04763	6	66	24	17	36			●		
	0.1875	3/16	5		GD05C-04763	6	74	36	29	36			●		
4.8	0.1890	--	3	External coolant	GD03-0480	6	66	28	20	36		M5×0.5	●		
	0.1890	--	5		GD05-0480	6	82	44	35	36			●		
	0.1890	--	3	Internal coolant	GD03C-0480	6	66	28	20	36			●		
	0.1890	--	5		GD05C-0480	6	82	44	35	36			●		
	0.1890	--	8		GD08C-0480	6	95	57	48	36			○		

● Stock available ○ Make-to-order

Drill diameter d ₁ (m ₇)			Drilling depth (l/d)	Cooling mode	Shank type	Type	Basic dimension(mm)					Suitable for thread		Grade		
mm	inch	Fraction					Shank diameter d ₂ (h ₆)	Overall length l ₁	Flute length l ₂	Recommended drilling depth l ₃	Shank length l ₄	cutting taps / tread milling cutters	forming taps			
4.9	0.1929	--	3	External coolant	Straight shank	GD03-0490	6	66	28	20	36	M6×1	NO.12-24UNC	●		
	0.1929	--	5			GD05-0490	6	82	44	35	36			●		
	0.1929	--	3	Internal coolant		GD03C-0490	6	66	28	20	36			●		
	0.1929	--	5			GD05C-0490	6	82	44	35	36			●		
	0.1929	--	8			GD08C-0490	6	95	57	48	36			○		
5.0	0.1969	--	3	External coolant		GD03-0500	6	66	28	20	36			M6×1	NO.12-24UNC	●
	0.1969	--	5			GD05-0500	6	82	44	35	36					●
	0.1969	--	3	Internal coolant		GD03C-0500	6	66	28	20	36					●
	0.1969	--	5			GD05C-0500	6	82	44	35	36					●
	0.1969	--	8			GD08C-0500	6	95	57	48	36					○
5.1	0.2008	--	3	External coolant	GD03-0510	6	66	28	20	36	1/4-20UNC	NO.12-28UNF	●			
	0.2008	--	5		GD05-0510	6	82	44	35	36			●			
	0.2008	--	3	Internal coolant	GD03C-0510	6	66	28	20	36			●			
	0.2008	--	5		GD05C-0510	6	82	44	35	36			●			
	0.2008	--	8		GD08C-0510	6	95	57	48	36			○			
5.2	0.2047	--	3	External coolant	GD03-0520	6	66	28	20	36	M6×0.75		●			
	0.2047	--	5		GD05-0520	6	82	44	35	36			●			
	0.2047	--	3	Internal coolant	GD03C-0520	6	66	28	20	36			●			
	0.2047	--	5		GD05C-0520	6	82	44	35	36			●			
	0.2047	--	8		GD08C-0520	6	95	57	48	36			○			
5.25	0.2067	--	3	External coolant	GD03-0525	6	66	28	20	36	M6×0.75		●			
	0.2067	--	5		GD05-0525	6	82	44	35	36			●			
	0.2067	--	3	Internal coolant	GD03C-0525	6	66	28	20	36			●			
	0.2067	--	5		GD05C-0525	6	82	44	35	36			●			
	0.2067	--	8		GD08C-0525	6	95	57	48	36			○			
5.3	0.2087	--	3	External coolant	GD03-0530	6	66	28	20	36			●			
	0.2087	--	5		GD05-0530	6	82	44	35	36			●			
	0.2087	--	3	Internal coolant	GD03C-0530	6	66	28	20	36			●			
	0.2087	--	5		GD05C-0530	6	82	44	35	36			●			
	0.2087	--	8		GD08C-0530	6	95	57	48	36			○			
5.4	0.2126	--	3	External coolant	GD03-0540	6	66	28	20	36			●			
	0.2126	--	5		GD05-0540	6	82	44	35	36			●			
	0.2126	--	3	Internal coolant	GD03C-0540	6	66	28	20	36			●			
	0.2126	--	5		GD05C-0540	6	82	44	35	36			●			
	0.2126	--	8		GD08C-0540	6	95	57	48	36			○			

Note: For drilling depth (l/d) of 8 ,namely GD08C series, tolerance of shank diameter is h₈.

● Stock available ○ Make-to-order

Applicable material table

◎ Very suitable ○ Suitable

Grade	Workpiece material										
	Mild steel HB ≤ 180	Carbon steel, Alloy steel	Pre-hardened steel, Hardened steel			Stainless steel	Cast iron	Nodular cast iron	Aluminum alloy	Copper alloy	Heat resistant alloy
			~40HRC	~50HRC	~60HRC						
KDG3013	○	◎	◎			○	◎	◎			○

GD series universal machining

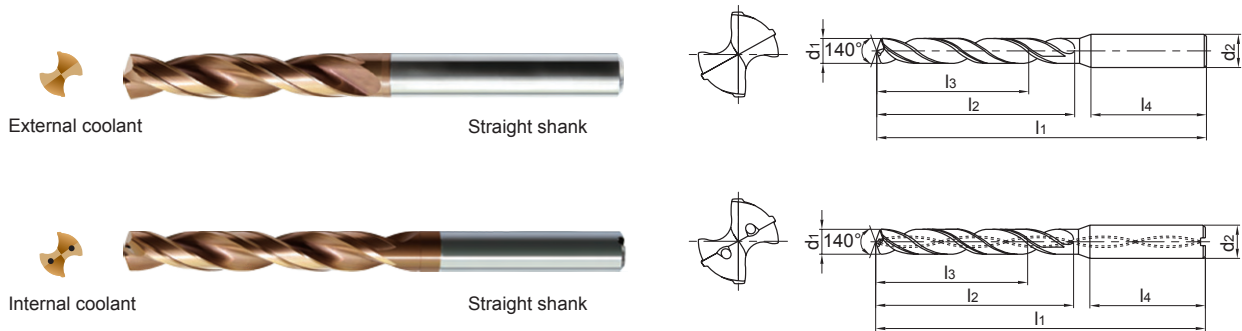

● Suitable for high efficiency drilling in a variety of materials e.g steel, stainless steel, cast iron.

Drill diameter d ₁ (m ₇)			Drilling depth (l/d)	Cooling mode	Shank type	Type	Basic dimension(mm)					Suitable for thread		Grade	
mm	inch	Fraction					Shank diameter	Overall length	Flute length	Recommended drilling depth	Shank length	cutting taps / tread milling cutters	forming taps		
									d ₂ (h ₆)	l ₁	l ₂	l ₃	l ₄		
5.5	0.2165	--	3	External coolant	Straight shank	GD03-0550	6	66	28	20	36	1/4-28UNF		●	
	0.2165	--	5			GD05-0550	6	82	44	35	36			●	
	0.2165	--	3	Internal coolant		GD03C-0550	6	66	28	20	36			●	
	0.2165	--	5			GD05C-0550	6	82	44	35	36			●	
	0.2165	--	8			GD08C-0550	6	95	57	48	36			○	
5.558	0.2188	7/32	3	External coolant		GD03-05558	6	66	28	20	36		●		
	0.2188	7/32	5			GD05-05558	6	82	44	35	36		●		
	0.2188	7/32	3	Internal coolant		GD03C-05558	6	66	28	20	36		●		
	0.2188	7/32	5			GD05C-05558	6	82	44	35	36		●		
5.6	0.2205	--	3	External coolant		GD03-0560	6	66	28	20	36	M6×1	●		
	0.2205	--	5		GD05-0560	6	82	44	35	36	●				
	0.2205	--	3	Internal coolant	GD03C-0560	6	66	28	20	36	●				
	0.2205	--	5		GD05C-0560	6	82	44	35	36	●				
	0.2205	--	8		GD08C-0560	6	95	57	48	36	○				
5.7	0.2244	--	3	External coolant	GD03-0570	6	66	28	20	36	M6×0.75	●			
	0.2244	--	5		GD05-0570	6	82	44	35	36		●			
	0.2244	--	3	Internal coolant	GD03C-0570	6	66	28	20	36		●			
	0.2244	--	5		GD05C-0570	6	82	44	35	36		●			
	0.2244	--	8		GD08C-0570	6	95	57	48	36		○			
5.75	0.2264	--	3	External coolant	GD03-0575	6	66	28	20	36	1/4-20UNC	●			
	0.2264	--	5		GD05-0575	6	82	44	35	36		●			
	0.2264	--	3	Internal coolant	GD03C-0575	6	66	28	20	36		●			
	0.2264	--	5		GD05C-0575	6	82	44	35	36		●			
5.8	0.2283	--	3	External coolant	GD03-0580	6	66	28	20	36		●			
	0.2283	--	5		GD05-0580	6	82	44	35	36		●			
	0.2283	--	3	Internal coolant	GD03C-0580	6	66	28	20	36		●			
	0.2283	--	5		GD05C-0580	6	82	44	35	36		●			
	0.2283	--	8		GD08C-0580	6	95	57	48	36		○			

● Stock available ○ Make-to-order

Drill diameter d ₁ (m7)			Drilling depth (l/d)	Cooling mode	Shank type	Type	Basic dimension(mm)					Suitable for thread		Grade
mm	inch	Fraction					Shank diameter d ₂ (h6)	Overall length l ₁	Flute length l ₂	Recommended drilling depth l ₃	Shank length l ₄	cutting taps / tread milling cutters	forming taps	
5.9	0.2323	--	3	External coolant	Straight shank	GD03-0590	6	66	28	20	36	M7×1	1/4-28UNF	●
	0.2323	--	5			GD05-0590	6	82	44	35	36			●
	0.2323	--	3	Internal coolant		GD03C-0590	6	66	28	20	36			●
	0.2323	--	5			GD05C-0590	6	82	44	35	36			●
	0.2323	--	8			GD08C-0590	6	95	57	48	36			○
5.95	0.2343	--	3	External coolant		GD03-0595	6	66	28	20	36			●
	0.2343	--	5			GD05-0595	6	82	44	35	36			●
	0.2343	--	3	Internal coolant		GD03C-0595	6	66	28	20	36			●
	0.2343	--	5			GD05C-0595	6	82	44	35	36			●
6.0	0.2362	--	3	External coolant		GD03-0600	6	66	28	20	36			●
	0.2362	--	5		GD05-0600	6	82	44	35	36	●			
	0.2362	--	3	Internal coolant	GD03C-0600	6	66	28	20	36	●			
	0.2362	--	5		GD05C-0600	6	82	44	35	36	●			
	0.2362	--	8		GD08C-0600	6	95	57	48	36	○			
6.1	0.2402	--	3	External coolant	GD03-0610	8	79	34	24	36	●			
	0.2402	--	5		GD05-0610	8	91	53	43	36	●			
	0.2402	--	3	Internal coolant	GD03C-0610	8	79	34	24	36	●			
	0.2402	--	5		GD05C-0610	8	91	53	43	36	●			
	0.2402	--	8		GD08C-0610	8	114	76	66	36	○			
6.2	0.2441	--	3	External coolant	GD03-0620	8	79	34	24	36	●			
	0.2441	--	5		GD05-0620	8	91	53	43	36	●			
	0.2441	--	3	Internal coolant	GD03C-0620	8	79	34	24	36	●			
	0.2441	--	5		GD05C-0620	8	91	53	43	36	●			
	0.2441	--	8		GD08C-0620	8	114	76	66	36	○			
6.3	0.2480	--	3	External coolant	GD03-0630	8	79	34	24	36	●			
	0.2480	--	5		GD05-0630	8	91	53	43	36	●			
	0.2480	--	3	Internal coolant	GD03C-0630	8	79	34	24	36	●			
	0.2480	--	5		GD05C-0630	8	91	53	43	36	●			
	0.2480	--	8		GD08C-0630	8	114	76	66	36	○			
6.35	0.2500	1/4	3	External coolant	GD03-06350	8	79	34	24	36	●			
	0.2500	1/4	5		GD05-06350	8	91	53	43	36	●			
	0.2500	1/4	3	Internal coolant	GD03C-06350	8	79	34	24	36	●			
	0.2500	1/4	5		GD05C-06350	8	91	53	43	36	●			
6.4	0.2520	--	3	External coolant	GD03-0640	8	79	34	24	36	●			
	0.2520	--	5		GD05-0640	8	91	53	43	36	●			

Note: For drilling depth (l/d) of 8 ,namely GD08C series, tolerance of shank diameter is h₈.

● Stock available ○ Make-to-order

Applicable material table

◎ Very suitable ○ Suitable

Grade	Workpiece material										
	Mild steel HB ≤ 180	Carbon steel, Alloy steel	Pre-hardened steel, Hardened steel			Stainless steel	Cast iron	Nodular cast iron	Aluminum alloy	Copper alloy	Heat resistant alloy
			~40HRC	~50HRC	~60HRC						
KDG3013	○	◎	◎			○	◎	◎			○

GD series universal machining

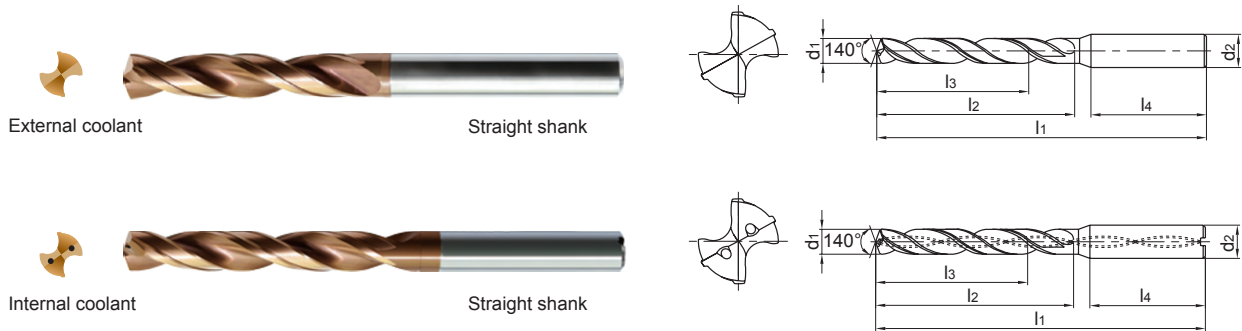

● Suitable for high efficiency drilling in a variety of materials e.g steel, stainless steel, cast iron.

Drill diameter d ₁ (m ₇)			Drilling depth (l/d)	Cooling mode	Shank type	Type	Basic dimension(mm)					Suitable for thread		Grade	
mm	inch	Fraction					Shank diameter	Overall length	Flute length	Recommended drilling depth	Shank length	cutting taps / tread milling cutters	forming taps		
									d ₂ (h ₆)	l ₁	l ₂	l ₃	l ₄		
6.4	0.2520	--	3	Internal coolant	Straight shank	GD03C-0640	8	79	34	24	36			●	
	0.2520	--	5			GD05C-0640	8	91	53	43	36			●	
	0.2520	--	8			GD08C-0640	8	114	76	66	36			○	
6.5	0.2559	--	3	External coolant		GD03-0650	8	79	34	24	36			●	
	0.2559	--	5			GD05-0650	8	91	53	43	36			●	
	0.2559	--	3	Internal coolant		GD03C-0650	8	79	34	24	36			●	
	0.2559	--	5			GD05C-0650	8	91	53	43	36			●	
	0.2559	--	8			GD08C-0650	8	114	76	66	36			○	
	0.2598	--	3			External coolant	GD03-0660	8	79	34	24	36			●
0.2598	--	5	GD05-0660	8			91	53	43	36			●		
0.2598	--	3	Internal coolant	GD03C-0660			8	79	34	24	36	5/16-18UNC	M7×1	●	
0.2598	--	5		GD05C-0660			8	91	53	43	36			●	
0.2598	--	8		GD08C-0660	8		114	76	66	36			○		
6.7	0.2638	--	3	External coolant	GD03-0670	8	79	34	24	36			●		
	0.2638	--	5		GD05-0670	8	91	53	43	36			●		
	0.2638	--	3	Internal coolant	GD03C-0670	8	79	34	24	36			●		
	0.2638	--	5		GD05C-0670	8	91	53	43	36			●		
	0.2638	--	8		GD08C-0670	8	114	76	66	36			○		
	0.2656	17/64	3		External coolant	GD03-06746	8	79	34	24	36			●	
0.2656	17/64	5	GD05-06746	8		91	53	43	36			●			
0.2656	17/64	3	Internal coolant	GD03C-06746		8	79	34	24	36			●		
0.2656	17/64	5		GD05C-06746		8	91	53	43	36			●		
6.8	0.2677	--	3	External coolant	GD03-0680	8	79	34	24	36			●		
	0.2677	--	5		GD05-0680	8	91	53	43	36			●		
	0.2677	--	3	Internal coolant	GD03C-0680	8	79	34	24	36			●		
	0.2677	--	5		GD05C-0680	8	91	53	43	36			●		
	0.2677	--	8		GD08C-0680	8	114	76	66	36			○		
6.9	0.2717	--	3	External coolant	GD03-0690	8	79	34	24	36	5/16-24UNF		●		
	0.2717	--	5		GD05-0690	8	91	53	43	36			●		

● Stock available ○ Make-to-order

Drill diameter d ₁ (m7)			Drilling depth (l/d)	Cooling mode	Shank type	Type	Basic dimension(mm)					Suitable for thread		Grade
mm	inch	Fraction					Shank diameter d ₂ (h6)	Overall length l ₁	Flute length l ₂	Recommended drilling depth l ₃	Shank length l ₄	cutting taps / tread milling cutters	forming taps	
6.9	0.2717	--	3	Internal coolant	Straight shank	GD03C-0690	8	79	34	24	36	5/16-24UNF	●	
	0.2717	--	5			GD05C-0690	8	91	53	43	36		●	
	0.2717	--	8			GD08C-0690	8	114	76	66	36		○	
7.0	0.2756	--	3	External coolant		GD03-0700	8	79	34	24	36	M8×1	●	
	0.2756	--	5			GD05-0700	8	91	53	43	36		●	
	0.2756	--	3	Internal coolant		GD03C-0700	8	79	34	24	36		●	
	0.2756	--	5			GD05C-0700	8	91	53	43	36		●	
7.1	0.2795	--	3	External coolant		GD08C-0700	8	116	76	66	36		○	
	0.2795	--	5			GD03-0710	8	79	41	29	36		●	
	0.2795	--	3	Internal coolant		GD05-0710	8	91	53	43	36		●	
	0.2795	--	5			GD03C-0710	8	79	41	29	36		●	
	0.2795	--	8			GD05C-0710	8	91	53	43	36		●	
7.145	0.2813	9/32	3	External coolant	GD08C-0710	8	116	76	66	36		○		
	0.2813	9/32	5		GD03-07145	8	79	41	29	36		●		
	0.2813	9/32	3	Internal coolant	GD05-07145	8	91	53	43	36		●		
	0.2813	9/32	5		GD03C-07145	8	79	41	29	36		●		
7.2	0.2835	--	3	External coolant	GD05C-07145	8	91	53	43	36		●		
	0.2835	--	5		GD03-0720	8	79	41	29	36		●		
	0.2835	--	3	Internal coolant	GD05-0720	8	91	53	43	36		●		
	0.2835	--	5		GD03C-0720	8	79	41	29	36		●		
	0.2835	--	8		GD05C-0720	8	91	53	43	36		●		
7.3	0.2874	--	3	External coolant	GD08C-0720	8	116	76	66	36	5/16-18UNC	○		
	0.2874	--	5		GD03-0730	8	79	41	29	36		●		
	0.2874	--	3	Internal coolant	GD05-0730	8	91	53	43	36		●		
	0.2874	--	5		GD03C-0730	8	79	41	29	36		●		
	0.2874	--	8		GD05C-0730	8	91	53	43	36		●		
7.4	0.2913	--	3	External coolant	GD08C-0730	8	116	76	66	36		○		
	0.2913	--	5		GD03-0740	8	79	41	29	36		●		
	0.2913	--	3	Internal coolant	GD05-0740	8	91	53	43	36		●		
	0.2913	--	5		GD03C-0740	8	79	41	29	36		●		
	0.2913	--	8		GD05C-0740	8	91	53	43	36		●		
7.45	0.2933	--	3	External coolant	GD08C-0740	8	116	76	66	36		○		
	0.2933	--	5		GD03-0745	8	79	41	29	36		●		
												5/16-24UNF	●	
													●	

Note: For drilling depth (l/d) of 8 ,namely GD08C series, tolerance of shank diameter is h₅.

● Stock available ○ Make-to-order

▶ Applicable material table

◎ Very suitable ○ Suitable

Grade	Workpiece material										
	Mild steel HB ≤ 180	Carbon steel, Alloy steel	Pre-hardened steel, Hardened steel			Stainless steel	Cast iron	Nodular cast iron	Aluminum alloy	Copper alloy	Heat resistant alloy
			~40HRC	~50HRC	~60HRC						
KDG3013	○	◎	◎			○	◎	◎			○

GD series universal machining

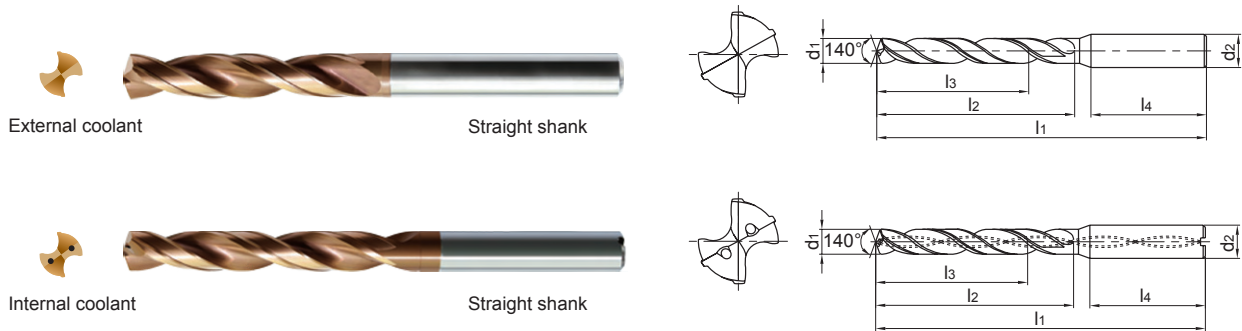

● Suitable for high efficiency drilling in a variety of materials e.g steel, stainless steel, cast iron.

Drill diameter d ₁ (m ₇)			Drilling depth (l/d)	Cooling mode	Shank type	Type	Basic dimension(mm)					Suitable for thread		Grade	
mm	inch	Fraction					Shank diameter	Overall length	Flute length	Recommended drilling depth	Shank length	cutting taps / tread milling cutters	forming taps		
									d ₂ (h ₆)	l ₁	l ₂	l ₃	l ₄		
7.45	0.2933	--	3	Internal coolant	Straight shank	GD03C-0745	8	79	41	29	36	M8×1.25	●		
	0.2933	--	5			GD05C-0745	8	91	53	43	36		5/16-24UNF	●	
7.5	0.2953	--	3	External coolant		GD03-0750	8	79	41	29	36		●		
		--	5			GD05-0750	8	91	53	43	36		●		
	0.2953	--	3	Internal coolant		GD03C-0750	8	79	41	29	36		●		
		--	5			GD05C-0750	8	91	53	43	36		●		
		--	8			GD08C-0750	8	116	76	66	36		○		
		--	3			GD03-07541	8	79	41	29	36		●		
7.541	0.2969	19/64	3	External coolant		GD05-07541	8	91	53	43	36	●			
		5	GD03C-07541			8	79	41	29	36	●				
	0.2969	19/64	3	Internal coolant		GD05C-07541	8	91	53	43	36	●			
		5	GD03-0760			8	79	41	29	36	●				
7.6	0.2992	--	3	External coolant		GD05-0760	8	91	53	43	36	M8×1	●		
		--	5			GD03C-0760	8	79	41	29	36		●		
	0.2992	--	3	Internal coolant		GD05C-0760	8	91	53	43	36		●		
		--	5			GD08C-0760	8	116	76	66	36		○		
7.7	0.3031	--	3	External coolant	GD03-0770	8	79	41	29	36		●			
		--	5		GD05-0770	8	91	53	43	36		●			
	0.3031	--	3	Internal coolant	GD03C-0770	8	79	41	29	36		●			
		--	5		GD05C-0770	8	91	53	43	36		●			
		--	8		GD08C-0770	8	116	76	66	36		○			
7.8	0.3071	--	3	External coolant	GD03-0780	8	79	41	29	36		●			
		--	5		GD05-0780	8	91	53	43	36		●			
	0.3071	--	3	Internal coolant	GD03C-0780	8	79	41	29	36		●			
		--	5		GD05C-0780	8	91	53	43	36		●			
		--	8		GD08C-0780	8	116	76	66	36		○			
7.9	0.3110	--	3	External coolant	GD03-0790	8	79	41	29	36	●				
		--	5		GD05-0790	8	91	53	43	36	●				

● Stock available ○ Make-to-order

Drill diameter d ₁ (mm)			Drilling depth (l/d)	Cooling mode	Shank type	Type	Basic dimension(mm)					Suitable for thread		Grade
mm	inch	Fraction					Shank diameter d ₂ (h ₆)	Overall length l ₁	Flute length l ₂	Recommended drilling depth l ₃	Shank length l ₄	cutting taps / tread milling cutters	forming taps	
7.9	0.3110	--	3	Internal coolant	Straight shank	GD03C-0790	8	79	41	29	36	3/8-16UNC		●
	0.3110	--	5			GD05C-0790	8	91	53	43	36			●
	0.3110	--	8			GD08C-0790	8	116	76	66	36			○
7.938	0.3125	5/16	3	External coolant		GD03-07938	8	79	41	29	36			●
	0.3125	5/16	5	GD05-07938		8	91	53	43	36	●			
	0.3125	5/16	3	Internal coolant		GD03C-07938	8	79	41	29	36			●
	0.3125	5/16	5	GD05C-07938		8	91	53	43	36	●			
8.0	0.3150	--	3	External coolant		GD03-0800	8	79	41	29	36			●
	0.3150	--	5	GD05-0800		8	91	53	43	36	●			
	0.3150	--	3	Internal coolant		GD03C-0800	8	79	41	29	36			●
	0.3150	--	5	GD05C-0800		8	91	53	43	36	●			
	0.3150	--	8	GD08C-0800		8	116	76	66	36	○			
8.1	0.3189	--	3	External coolant	GD03-0810	10	89	47	35	40	●			
	0.3189	--	5	GD05-0810	10	103	61	49	40	●				
	0.3189	--	3	Internal coolant	GD03C-0810	10	89	47	35	40	●			
	0.3189	--	5		GD05C-0810	10	103	61	49	40	●			
	0.3189	--	8		GD08C-0810	10	142	95	83	40	○			
8.2	0.3228	--	3	External coolant	GD03-0820	10	89	47	35	40	●			
	0.3228	--	5	GD05-0820	10	103	61	49	40	●				
	0.3228	--	3	Internal coolant	GD03C-0820	10	89	47	35	40	●			
	0.3228	--	5		GD05C-0820	10	103	61	49	40	●			
	0.3228	--	8		GD08C-0820	10	142	95	83	40	○			
8.3	0.3268	--	3	External coolant	GD03-0830	10	89	47	35	40	●			
	0.3268	--	5	GD05-0830	10	103	61	49	40	●				
	0.3268	--	3	Internal coolant	GD03C-0830	10	89	47	35	40	●			
	0.3268	--	5		GD05C-0830	10	103	61	49	40	●			
	0.3268	--	8		GD08C-0830	10	142	95	83	40	○			
8.334	0.3281	21/64	3	External coolant	GD03-08334	10	89	47	35	40	●			
	0.3281	21/64	5	GD05-08334	10	103	61	49	40	●				
	0.3281	21/64	3	Internal coolant	GD03C-08334	10	89	47	35	40	●			
	0.3281	21/64	5		GD05C-08334	10	103	61	49	40	●			
8.4	0.3307	--	3	External coolant	GD03-0840	10	89	47	35	40	●			
	0.3307	--	5		GD05-0840	10	103	61	49	40	●			

Note: For drilling depth (l/d) of 8, namely GD08C series, tolerance of shank diameter is h₈.

● Stock available ○ Make-to-order

Applicable material table

◎ Very suitable ○ Suitable

Grade	Workpiece material										
	Mild steel HB ≤ 180	Carbon steel, Alloy steel	Pre-hardened steel, Hardened steel			Stainless steel	Cast iron	Nodular cast iron	Aluminum alloy	Copper alloy	Heat resistant alloy
			~40HRC	~50HRC	~60HRC						
KDG3013	○	◎	◎			○	◎	◎		○	

GD series universal machining

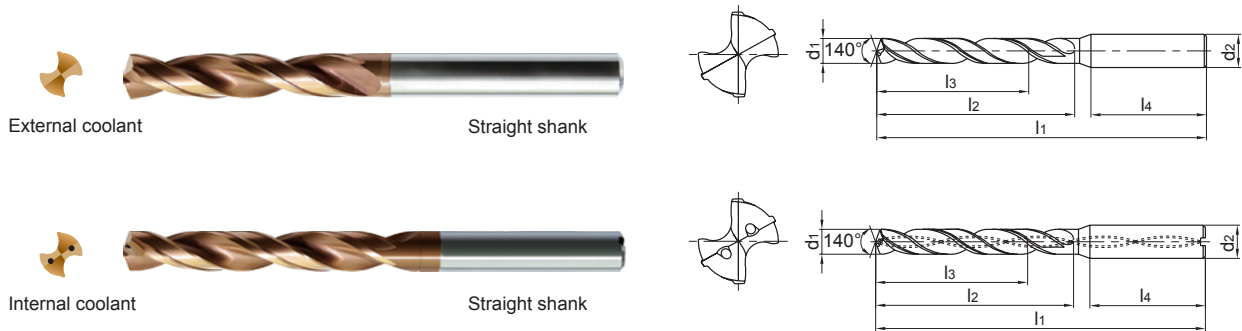

● Suitable for high efficiency drilling in a variety of materials e.g steel, stainless steel, cast iron.

Drill diameter d ₁ (m ₇)			Drilling depth (l/d)	Cooling mode	Shank type	Type	Basic dimension(mm)					Suitable for thread		Grade						
mm	inch	Fraction					Shank diameter	Overall length	Flute length	Recommended drilling depth	Shank length	cutting taps / tread milling cutters	forming taps							
							d ₂ (h ₆)	l ₁	l ₂	l ₃	l ₄			KDGS3013						
8.4	0.3307	--	3	Internal coolant	Straight shank	GD03C-0840	10	89	47	35	40	M10×1.5 3/8-24UNF		●						
	0.3307	--	5			GD05C-0840	10	103	61	49	40			●						
	0.3307	--	8			GD08C-0840	10	142	95	83	40			○						
8.5	0.3346	--	3	External coolant		GD03-0850	10	89	47	35	40			M10×1.5 3/8-24UNF		●				
	0.3346	--	5			GD05-0850	10	103	61	49	40					●				
	0.3346	--	3	Internal coolant		GD03C-0850	10	89	47	35	40					●				
	0.3346	--	5			GD05C-0850	10	103	61	49	40					●				
	0.3346	--	8			GD08C-0850	10	142	95	83	40					○				
	0.3346	--	3			External coolant	GD03-0860	10	89	47	35					40			●	
0.3386	--	5	GD05-0860	10			103	61	49	40	●									
0.3386	--	3	Internal coolant	GD03C-0860			10	89	47	35	40			●						
0.3386	--	5		GD05C-0860		10	103	61	49	40	●									
0.3386	--	8		GD08C-0860	10	142	95	83	40	○										
8.6	0.3386	--	3	Internal coolant	Straight shank	GD03-0870	10	89	47	35	40	M10×1.5 3/8-24UNF		●						
	0.3386	--	5			GD05-0870	10	103	61	49	40			●						
	0.3386	--	3			External coolant	GD03C-0870	10	89	47	35			40			●			
	0.3425	--	5				GD05C-0870	10	103	61	49			40			●			
	0.3425	--	3				Internal coolant	GD03-0873	10	89	47			35			40			●
	0.3425	--	5					GD05-0873	10	103	61			49			40			●
8.7	0.3425	--	8	External coolant		GD08C-0870	10	142	95	83	40					○				
	0.3438	11/32	3			Internal coolant	GD03-0873	10	89	47	35					40			●	
	0.3438	11/32	5				GD05-0873	10	103	61	49					40			●	
	0.3438	11/32	3				External coolant	GD03C-0873	10	89	47					35			40	
0.3438	11/32	5	GD05C-0873	10				103	61	49	40			●						
8.8	0.3465	--	3	Internal coolant		Straight shank	GD03-0880	10	89	47	35			40	M10×1.5 3/8-24UNF		●			
	0.3465	--	5		GD05-0880		10	103	61	49	40	●								
	0.3465	--	3		External coolant		GD03C-0880	10	89	47	35	40	3/8-16UNC				●			
	0.3465	--	5				GD05C-0880	10	103	61	49	40					●			
	0.3465	--	8				GD08C-0880	10	142	95	83	40					○			
8.9	0.3504	--	3	External coolant	GD03-0890		10	89	47	35	40			●						
	0.3504	--	5		GD05-0890		10	103	61	49	40			●						

● Stock available ○ Make-to-order

Drill diameter d ₁ (m ₇)			Drilling depth (l/d)	Cooling mode	Shank type	Type	Basic dimension(mm)					Suitable for thread		Grade				
mm	inch	Fraction					Shank diameter d ₂ (h ₆)	Overall length l ₁	Flute length l ₂	Recommended drilling depth l ₃	Shank length l ₄	cutting taps / tread milling cutters	forming taps					
8.9	0.3504	--	3	Internal coolant	Straight shank	GD03C-0890	10	89	47	35	40	M10×1	3/8-24UNF	●				
	0.3504	--	5			GD05C-0890	10	103	61	49	40			●				
	0.3504	--	8			GD08C-0890	10	142	95	83	40			○				
9.0	0.3543	--	3	External coolant		GD03-0900	10	89	47	35	40			M10×1	3/8-24UNF	●		
	0.3543	--	5			GD05-0900	10	103	61	49	40					●		
	0.3543	--	3	Internal coolant		GD03C-0900	10	89	47	35	40					●		
	0.3543	--	5			GD05C-0900	10	103	61	49	40					●		
	0.3543	--	8			GD08C-0900	10	142	95	83	40					○		
	0.3583	--	3			External coolant	GD03-0910	10	89	47	35					40	M10×1	3/8-24UNF
0.3583	--	5	GD05-0910	10			103	61	49	40	●							
9.1	0.3583	--	3	Internal coolant		GD03C-0910	10	89	47	35	40			M10×1	3/8-24UNF	●		
	0.3583	--	5			GD05C-0910	10	103	61	49	40					●		
	0.3583	--	8	External coolant	GD03-09129	10	89	47	35	40	M10×1	3/8-24UNF	●					
	0.3594	23/64	5		GD05-09129	10	103	61	49	40			●					
9.129	0.3594	23/64	3	Internal coolant	GD03C-09129	10	89	47	35	40	M10×1	3/8-24UNF	●					
	0.3594	23/64	5		GD05C-09129	10	103	61	49	40			●					
	0.3622	--	3		External coolant	GD03-0920	10	89	47	35			40	M10×1	3/8-24UNF	●		
	0.3622	--	5			GD05-0920	10	103	61	49			40			●		
9.2	0.3622	--	3	Internal coolant	GD03C-0920	10	89	47	35	40	M10×1	3/8-24UNF	●					
	0.3622	--	5		GD05C-0920	10	103	61	49	40			●					
	0.3622	--	8		External coolant	GD03-0920	10	89	47	35			40	M10×1	3/8-24UNF	○		
	0.3661	--	3			GD05-0920	10	103	61	49			40			M10×1	3/8-24UNF	●
	0.3661	--	5				GD08C-0920	10	142	95			83					40
9.3	0.3661	--	3	Internal coolant	GD03-0930	10	89	47	35	40	M10×1	3/8-24UNF	●					
	0.3661	--	5		GD05-0930	10	103	61	49	40			●					
	0.3661	--	3		External coolant	GD03C-0930	10	89	47	35			40	M10×1	3/8-24UNF	●		
	0.3661	--	5			GD05-0930	10	103	61	49			40			M10×1	3/8-24UNF	●
	0.3661	--	8				GD08C-0930	10	142	95			83					40
9.35	0.3681	--	3	Internal coolant	GD03-0935	10	89	47	35	40	M10×1.5	3/8-24UNF	●					
	0.3681	--	5		GD05-0935	10	103	61	49	40			●					
	0.3681	--	3		External coolant	GD03C-0935	10	89	47	35			40	M10×1.5	3/8-24UNF	●		
	0.3681	--	5			GD05C-0935	10	103	61	49			40			●		

Note: For drilling depth (l/d) of 8, namely GD08C series, tolerance of shank diameter is h₈.

● Stock available ○ Make-to-order

▶ Applicable material table

◎ Very suitable ○ Suitable

Grade	Workpiece material										
	Mild steel HB ≤ 180	Carbon steel, Alloy steel	Pre-hardened steel, Hardened steel			Stainless steel	Cast iron	Nodular cast iron	Aluminum alloy	Copper alloy	Heat resistant alloy
			~40HRC	~50HRC	~60HRC						
KDG3013	○	◎	◎			○	◎	◎			○

GD series universal machining

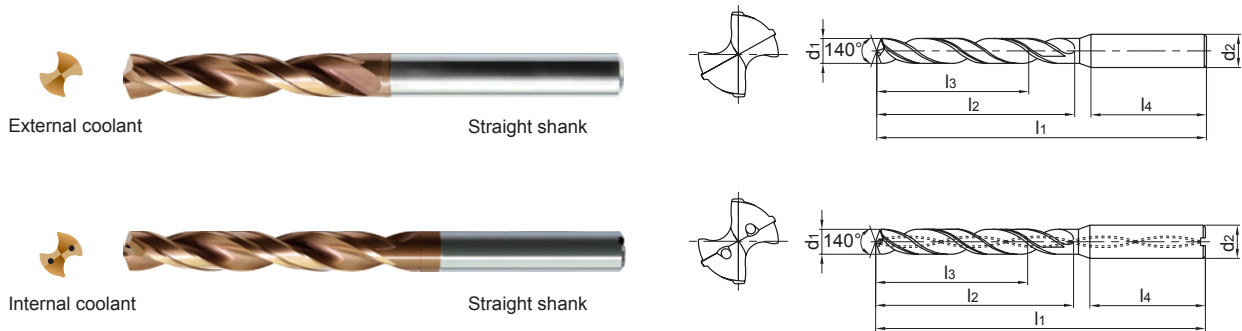

● Suitable for high efficiency drilling in a variety of materials e.g steel, stainless steel, cast iron.

Drill diameter d ₁ (m ₇)			Drilling depth (l/d)	Cooling mode	Shank type	Type	Basic dimension(mm)					Suitable for thread		Grade	
mm	inch	Fraction					Shank diameter	Overall length	Flute length	Recommended drilling depth	Shank length	cutting taps / tread milling cutters	forming taps		
									d ₂ (h ₆)	l ₁	l ₂	l ₃	l ₄		
9.4	0.3701	--	3	External coolant	Straight shank	GD03-0940	10	89	47	35	40	7/16-14UNC		●	
	0.3701	--	5			GD05-0940	10	103	61	49	40			●	
	0.3701	--	3	Internal coolant		GD03C-0940	10	89	47	35	40			●	
	0.3701	--	5			GD05C-0940	10	103	61	49	40			●	
	0.3701	--	8			GD08C-0940	10	142	95	83	40			○	
9.45	0.3720	--	3	External coolant		GD03-0945	10	89	47	35	40	M10×1.25		●	
	0.3720	--	5			GD05-0945	10	103	61	49	40			●	
	0.3720	--	3	Internal coolant		GD03C-0945	10	89	47	35	40			●	
	0.3720	--	5			GD05C-0945	10	103	61	49	40			●	
9.5	0.3740	--	3	External coolant		GD03-0950	10	89	47	35	40				
	0.3740	--	5		GD05-0950	10	103	61	49	40	●				
	0.3740	--	3	Internal coolant	GD03C-0950	10	89	47	35	40	●				
	0.3740	--	5		GD05C-0950	10	103	61	49	40	●				
	0.3740	--	8		GD08C-0950	10	142	95	83	40	○				
9.525	0.3750	3/8	3	External coolant	GD03-09525	10	89	47	35	40			●		
	0.3750	3/8	5		GD05-09525	10	103	61	49	40			●		
	0.3750	3/8	3	Internal coolant	GD03C-09525	10	89	47	35	40			●		
	0.3750	3/8	5		GD05C-09525	10	103	61	49	40			●		
9.6	0.3780	--	3	External coolant	GD03-0960	10	89	47	35	40			M10×1		
	0.3780	--	5		GD05-0960	10	103	61	49	40				●	
	0.3780	--	3	Internal coolant	GD03C-0960	10	89	47	35	40				●	
	0.3780	--	5		GD05C-0960	10	103	61	49	40				●	
	0.3780	--	8		GD08C-0960	10	142	95	83	40	○				
9.7	0.3819	--	3	External coolant	GD03-0970	10	89	47	35	40				●	
	0.3819	--	5		GD05-0970	10	103	61	49	40				●	
	0.3819	--	3	Internal coolant	GD03C-0970	10	89	47	35	40				●	
	0.3819	--	5		GD05C-0970	10	103	61	49	40				●	
	0.3819	--	8		GD08C-0970	10	142	95	83	40				○	

● Stock available ○ Make-to-order

Drill diameter d ₁ (mm)			Drilling depth (l/d)	Cooling mode	Shank type	Type	Basic dimension(mm)					Suitable for thread		Grade		
mm	inch	Fraction					Shank diameter d ₂ (h ₆)	Overall length l ₁	Flute length l ₂	Recommended drilling depth l ₃	Shank length l ₄	cutting taps / tread milling cutters	forming taps			
9.8	0.3858	--	3	External coolant	Straight shank	GD03-0980	10	89	47	35	40	7/16-20UNF		●		
	0.3858	--	5			GD05-0980	10	103	61	49	40			●		
	0.3858	--	3	Internal coolant		GD03C-0980	10	89	47	35	40			●		
	0.3858	--	5			GD05C-0980	10	103	61	49	40			●		
	0.3858	--	8			GD08C-0980	10	142	95	83	40			○		
9.9	0.3898	--	3	External coolant		GD03-0990	10	89	47	35	40			7/16-20UNF		●
	0.3898	--	5			GD05-0990	10	103	61	49	40					●
	0.3898	--	3	Internal coolant		GD03C-0990	10	89	47	35	40					●
	0.3898	--	5			GD05C-0990	10	103	61	49	40					●
	0.3898	--	8			GD08C-0990	10	142	95	83	40					○
9.921	0.3906	25/64	3	External coolant	GD03-09921	10	89	47	35	40			●			
	0.3906	25/64	5		GD05-09921	10	103	61	49	40			●			
	0.3906	25/64	3	Internal coolant	GD03C-09921	10	89	47	35	40			●			
	0.3906	25/64	5		GD05C-09921	10	103	61	49	40			●			
10.0	0.3937	--	3	External coolant	GD03-1000	10	89	47	35	40			●			
	0.3937	--	5		GD05-1000	10	103	61	49	40			●			
	0.3937	--	3	Internal coolant	GD03C-1000	10	89	47	35	40			●			
	0.3937	--	5		GD05C-1000	10	103	61	49	40			●			
	0.3937	--	8		GD08C-1000	10	142	95	83	40			○			
10.1	0.3976	--	3	External coolant	GD03-1010	12	102	55	40	45			●			
	0.3976	--	5		GD05-1010	12	118	71	56	45			●			
	0.3976	--	3	Internal coolant	GD03C-1010	12	102	55	40	45			●			
	0.3976	--	5		GD05C-1010	12	118	71	56	45			●			
	0.3976	--	8		GD08C-1010	12	162	114	99	45			○			
10.2	0.4016	--	3	External coolant	GD03-1020	12	102	55	40	45			●			
	0.4016	--	5		GD05-1020	12	118	71	56	45			●			
	0.4016	--	3	Internal coolant	GD03C-1020	12	102	55	40	45			●			
	0.4016	--	5		GD05C-1020	12	118	71	56	45			●			
	0.4016	--	8		GD08C-1020	12	162	114	99	45			○			
10.25	0.4035	--	3	External coolant	GD03-1025	12	102	55	40	45	M12×1.75		●			
	0.4035	--	5		GD05-1025	12	118	71	56	45			●			
	0.4035	--	3	Internal coolant	GD03C-1025	12	102	55	40	45			●			
	0.4035	--	5		GD05C-1025	12	118	71	56	45			●			

Note: For drilling depth (l/d) of 8, namely GD08C series, tolerance of shank diameter is h₈.

● Stock available ○ Make-to-order

▶ Applicable material table

◎ Very suitable ○ Suitable

Grade	Workpiece material										
	Mild steel HB ≤ 180	Carbon steel, Alloy steel	Pre-hardened steel, Hardened steel			Stainless steel	Cast iron	Nodular cast iron	Aluminum alloy	Copper alloy	Heat resistant alloy
			~40HRC	~50HRC	~60HRC						
KDG3013	○	◎	◎			○	◎	◎			○

GD series universal machining

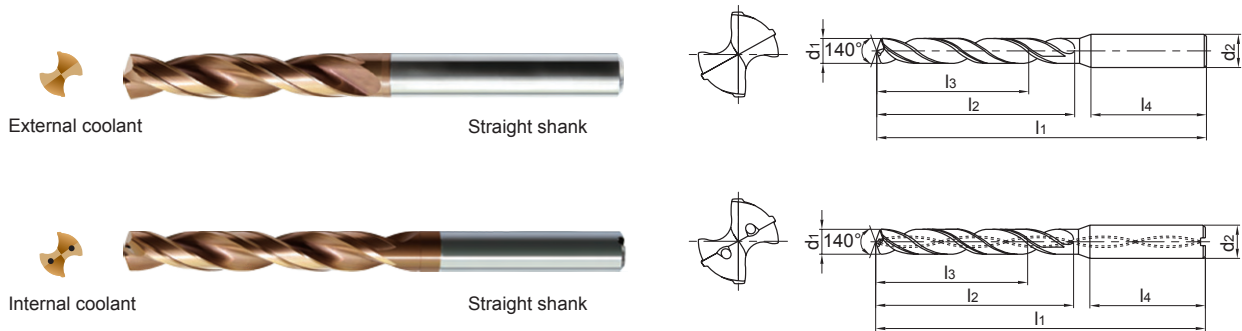

● Suitable for high efficiency drilling in a variety of materials e.g steel, stainless steel, cast iron.

Drill diameter d ₁ (m ₇)			Drilling depth (l/d)	Cooling mode	Shank type	Type	Basic dimension(mm)					Suitable for thread		Grade
mm	inch	Fraction					Shank diameter	Overall length	Flute length	Recommended drilling depth	Shank length	cutting taps / tread milling cutters	forming taps	
							d ₂ (h ₆)	l ₁	l ₂	l ₃	l ₄			KDG3013
10.3	0.4055	--	3	External coolant	Straight shank	GD03-1030	12	102	55	40	45		7/16-14UNC	●
	0.4055	--	5			GD05-1030	12	118	71	56	45			●
	0.4055	--	3	Internal coolant		GD03C-1030	12	102	55	40	45			●
	0.4055	--	5			GD05C-1030	12	118	71	56	45			●
	0.4055	--	8			GD08C-1030	12	162	114	99	45			○
10.32	0.4063	13/32	3	External coolant		GD03-10320	12	102	55	40	45			●
	0.4063	13/32	5			GD05-10320	12	118	71	56	45			●
	0.4063	13/32	3	Internal coolant		GD03C-10320	12	102	55	40	45			●
	0.4063	13/32	5			GD05C-10320	12	118	71	56	45			●
10.4	0.4094	--	3	External coolant		GD03-1040	12	102	55	40	45			●
	0.4094	--	5		GD05-1040	12	118	71	56	45	●			
	0.4094	--	3	Internal coolant	GD03C-1040	12	102	55	40	45	●			
	0.4094	--	5		GD05C-1040	12	118	71	56	45	●			
	0.4094	--	8		GD08C-1040	12	162	114	99	45	○			
10.5	0.4134	--	3	External coolant	GD03-1050	12	102	55	40	45	M12×1.5	7/16-20UNF	●	
	0.4134	--	5		GD05-1050	12	118	71	56	45			●	
	0.4134	--	3	Internal coolant	GD03C-1050	12	102	55	40	45			●	
	0.4134	--	5		GD05C-1050	12	118	71	56	45			●	
	0.4134	--	8		GD08C-1050	12	162	114	99	45			○	
10.6	0.4173	--	3	External coolant	GD03-1060	12	102	55	40	45			●	
	0.4173	--	5		GD05-1060	12	118	71	56	45			●	
	0.4173	--	3	Internal coolant	GD03C-1060	12	102	55	40	45			●	
	0.4173	--	5		GD05C-1060	12	118	71	56	45			●	
	0.4173	--	8		GD08C-1060	12	162	114	99	45			○	
10.7	0.4213	--	3	External coolant	GD03-1070	12	102	55	40	45			●	
	0.4213	--	5		GD05-1070	12	118	71	56	45			●	
	0.4213	--	3	Internal coolant	GD03C-1070	12	102	55	40	45			●	
	0.4213	--	5		GD05C-1070	12	118	71	56	45			●	
	0.4213	--	8		GD08C-1070	12	162	114	99	45			○	

● Stock available ○ Make-to-order

Drill diameter d ₁ (m ₇)			Drilling depth (l/d)	Cooling mode	Shank type	Type	Basic dimension(mm)					Suitable for thread		Grade		
mm	inch	Fraction					Shank diameter d ₂ (h ₆)	Overall length l ₁	Flute length l ₂	Recommended drilling depth l ₃	Shank length l ₄	cutting taps / tread milling cutters	forming taps			
10.716	0.4219	27/64	3	External coolant	Straight shank	GD03-10716	12	102	55	40	45	M12×1.25		●		
	0.4219	27/64	5			GD05-10716	12	118	71	56	45			●		
	0.4219	27/64	3	Internal coolant		GD03C-10716	12	102	55	40	45			●		
	0.4219	27/64	5			GD05C-10716	12	118	71	56	45			●		
10.75	0.4232	--	3	External coolant		GD03-1075	12	102	55	40	45			1/2-13UNC		●
	0.4232	--	5			GD05-1075	12	118	71	56	45					●
	0.4232	--	3	Internal coolant		GD03C-1075	12	102	55	40	45					●
	0.4232	--	5			GD05C-1075	12	118	71	56	45					●
10.8	0.4252	--	3	External coolant	GD03-1080	12	102	55	40	45			●			
	0.4252	--	5		GD05-1080	12	118	71	56	45			●			
	0.4252	--	3	Internal coolant	GD03C-1080	12	102	55	40	45			●			
	0.4252	--	5		GD05C-1080	12	118	71	56	45			●			
	0.4252	--	8		GD08C-1080	12	162	114	99	45			○			
10.9	0.4291	--	3	External coolant	GD03-1090	12	102	55	40	45					●	
	0.4291	--	5		GD05-1090	12	118	71	56	45					●	
	0.4291	--	3	Internal coolant	GD03C-1090	12	102	55	40	45					●	
	0.4291	--	5		GD05C-1090	12	118	71	56	45	●					
	0.4291	--	8		GD08C-1090	12	162	114	99	45	○					
11.0	0.4331	--	3	External coolant	GD03-1100	12	102	55	40	45					●	
	0.4331	--	5		GD05-1100	12	118	71	56	45					●	
	0.4331	--	3	Internal coolant	GD03C-1100	12	102	55	40	45					●	
	0.4331	--	5		GD05C-1100	12	118	71	56	45			●			
	0.4331	--	8		GD08C-1100	12	162	114	99	45			○			
11.1	0.4370	--	3	External coolant	GD03-1110	12	102	55	40	45					●	
	0.4370	--	5		GD05-1110	12	118	71	56	45					●	
	0.4370	--	3	Internal coolant	GD03C-1110	12	102	55	40	45					●	
	0.4370	--	5		GD05C-1110	12	118	71	56	45	●					
	0.4370	--	8		GD08C-1110	12	162	114	99	45	○					
11.113	0.4375	7/16	3	External coolant	GD03-11113	12	102	55	40	45					●	
	0.4375	7/16	5		GD05-11113	12	118	71	56	45					●	
	0.4375	7/16	3	Internal coolant	GD03C-11113	12	102	55	40	45					●	
	0.4375	7/16	5		GD05C-11113	12	118	71	56	45			●			

Note: For drilling depth (l/d) of 8, namely GD08C series, tolerance of shank diameter is h₈.

● Stock available ○ Make-to-order

Applicable material table

◎ Very suitable ○ Suitable

Grade	Workpiece material										
	Mild steel HB ≤ 180	Carbon steel, Alloy steel	Pre-hardened steel, Hardened steel			Stainless steel	Cast iron	Nodular cast iron	Aluminum alloy	Copper alloy	Heat resistant alloy
			~40HRC	~50HRC	~60HRC						
KDG3013	○	◎	◎			○	◎	◎			○

GD series universal machining

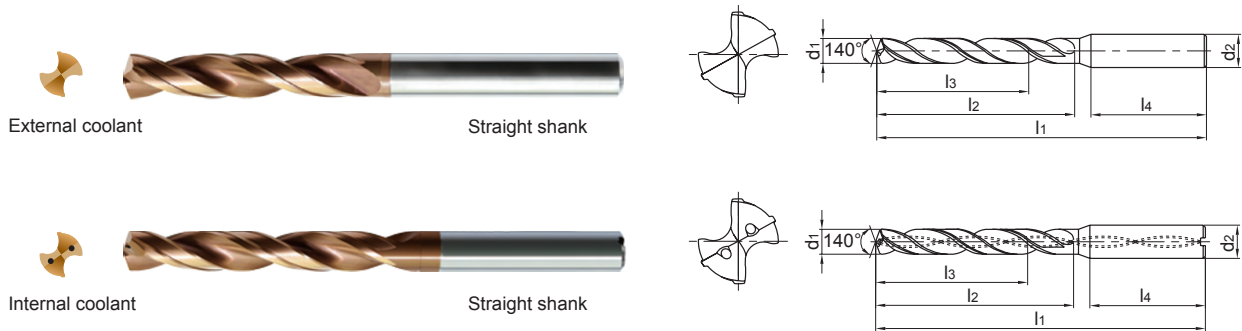

● Suitable for high efficiency drilling in a variety of materials e.g steel, stainless steel, cast iron.

Drill diameter d ₁ (m ₇)			Drilling depth (l/d)	Cooling mode	Shank type	Type	Basic dimension(mm)					Suitable for thread		Grade	
mm	inch	Fraction					Shank diameter	Overall length	Flute length	Recommended drilling depth	Shank length	cutting taps / tread milling cutters	forming taps		
									d ₂ (h ₆)	l ₁	l ₂	l ₃	l ₄		
11.2	0.4409	--	3	External coolant	Straight shank	GD03-1120	12	102	55	40	45			●	
	0.4409	--	5			GD05-1120	12	118	71	56	45			●	
	0.4409	--	3	Internal coolant		GD03C-1120	12	102	55	40	45			●	
	0.4409	--	5			GD05C-1120	12	118	71	56	45			●	
	0.4409	--	8			GD08C-1120	12	162	114	99	45			○	
11.25	0.4429	--	3	External coolant		GD03-1125	12	102	55	40	45		M12×1.75	●	
	0.4429	--	5			GD05-1125	12	118	71	56	45			●	
	0.4429	--	3	Internal coolant		GD03C-1125	12	102	55	40	45			●	
	0.4429	--	5			GD05C-1125	12	118	71	56	45			●	
11.3	0.4449	--	3	External coolant		GD03-1130	12	102	55	40	45			●	
	0.4449	--	5		GD05-1130	12	118	71	56	45		●			
	0.4449	--	3	Internal coolant	GD03C-1130	12	102	55	40	45		●			
	0.4449	--	5		GD05C-1130	12	118	71	56	45		●			
	0.4449	--	8		GD08C-1130	12	162	114	99	45		○			
11.35	0.4469	--	3	External coolant	GD03-1135	12	102	55	40	45		M12×1.5	●		
	0.4469	--	5		GD05-1135	12	118	71	56	45			●		
	0.4469	--	3	Internal coolant	GD03C-1135	12	102	55	40	45			●		
	0.4469	--	5		GD05C-1135	12	118	71	56	45			●		
	0.4469	--	8		GD08C-1135	12	162	114	99	45			○		
11.4	0.4488	--	3	External coolant	GD03-1140	12	102	55	40	45			●		
	0.4488	--	5		GD05-1140	12	118	71	56	45			●		
	0.4488	--	3	Internal coolant	GD03C-1140	12	102	55	40	45			●		
	0.4488	--	5		GD05C-1140	12	118	71	56	45			●		
	0.4488	--	8		GD08C-1140	12	162	114	99	45			○		
11.45	0.4508	--	3	External coolant	GD03-1145	12	102	55	40	45		M12×1.25	●		
	0.4508	--	5		GD05-1145	12	118	71	56	45			●		
	0.4508	--	3	Internal coolant	GD03C-1145	12	102	55	40	45			●		
	0.4508	--	5		GD05C-1145	12	118	71	56	45			●		

● Stock available ○ Make-to-order

Drill diameter d ₁ (m ₇)			Drilling depth (l/d)	Cooling mode	Shank type	Type	Basic dimension(mm)					Suitable for thread		Grade
mm	inch	Fraction					Shank diameter d ₂ (h ₆)	Overall length l ₁	Flute length l ₂	Recommended drilling depth l ₃	Shank length l ₄	cutting taps / tread milling cutters	forming taps	
11.5	0.4528	--	3	External coolant	Straight shank	GD03-1150	12	102	55	40	45	1/2-20UNF		●
	0.4528	--	5			GD05-1150	12	118	71	56	45			●
	0.4528	--	3	Internal coolant		GD03C-1150	12	102	55	40	45			●
	0.4528	--	5			GD05C-1150	12	118	71	56	45			●
	0.4528	--	8			GD08C-1150	12	162	114	99	45			○
11.6	0.4567	--	3	External coolant		GD03-1160	12	102	55	40	45			●
	0.4567	--	5			GD05-1160	12	118	71	56	45			●
	0.4567	--	3	Internal coolant		GD03C-1160	12	102	55	40	45			●
	0.4567	--	5			GD05C-1160	12	118	71	56	45			●
	0.4567	--	8			GD08C-1160	12	162	114	99	45			○
11.7	0.4606	--	3	External coolant	GD03-1170	12	102	55	40	45			●	
	0.4606	--	5		GD05-1170	12	118	71	56	45			●	
	0.4606	--	3	Internal coolant	GD03C-1170	12	102	55	40	45			●	
	0.4606	--	5		GD05C-1170	12	118	71	56	45			●	
	0.4606	--	8		GD08C-1170	12	162	114	99	45			○	
11.8	0.4646	--	3	External coolant	GD03-1180	12	102	55	40	45	1/2-13UNC		●	
	0.4646	--	5		GD05-1180	12	118	71	56	45			●	
	0.4646	--	3	Internal coolant	GD03C-1180	12	102	55	40	45			●	
	0.4646	--	5		GD05C-1180	12	118	71	56	45			●	
	0.4646	--	8		GD08C-1180	12	162	114	99	45			○	
11.9	0.4685	--	3	External coolant	GD03-1190	12	102	55	40	45			●	
	0.4685	--	5		GD05-1190	12	118	71	56	45			●	
	0.4685	--	3	Internal coolant	GD03C-1190	12	102	55	40	45			●	
	0.4685	--	5		GD05C-1190	12	118	71	56	45			●	
	0.4685	--	8		GD08C-1190	12	162	114	99	45			○	
12.0	0.4724	--	3	External coolant	GD03-1200	12	102	55	40	45	M14×2		●	
	0.4724	--	5		GD05-1200	12	118	71	56	45			●	
	0.4724	--	3	Internal coolant	GD03C-1200	12	102	55	40	45			●	
	0.4724	--	5		GD05C-1200	12	118	71	56	45			●	
	0.4724	--	8		GD08C-1200	12	162	114	99	45			○	
12.1	0.4764	--	3	External coolant	GD03-1210	14	107	60	43	45	1/2-20UNF		●	
	0.4764	--	5		GD05-1210	14	124	77	60	45			●	
	0.4764	--	3	Internal coolant	GD03C-1210	14	107	60	43	45			●	
	0.4764	--	5		GD05C-1210	14	124	77	60	45			●	

Note: For drilling depth (l/d) of 8, namely GD08C series, tolerance of shank diameter is h₈.

● Stock available ○ Make-to-order

Applicable material table

◎ Very suitable ○ Suitable

Grade	Workpiece material										
	Mild steel HB ≤ 180	Carbon steel, Alloy steel	Pre-hardened steel, Hardened steel			Stainless steel	Cast iron	Nodular cast iron	Aluminum alloy	Copper alloy	Heat resistant alloy
			~40HRC	~50HRC	~60HRC						
KDG3013	○	◎	◎			○	◎	◎			○

GD series universal machining

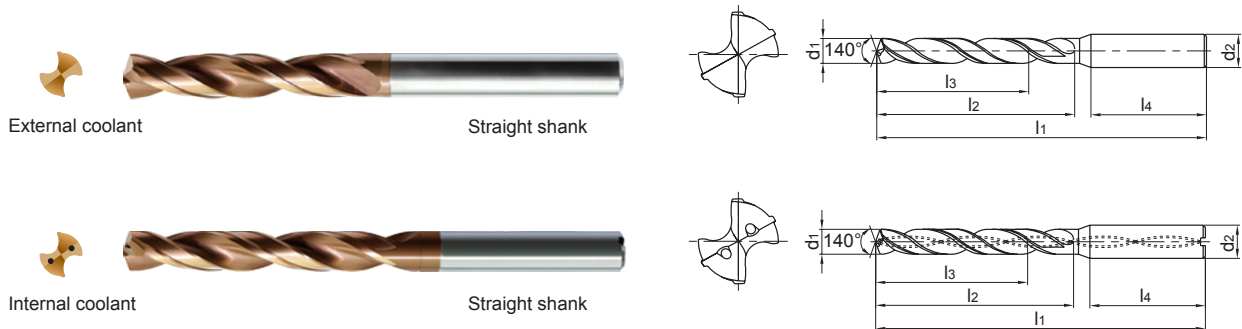

● Suitable for high efficiency drilling in a variety of materials e.g steel, stainless steel, cast iron.

Drill diameter d ₁ (m7)			Drilling depth (l/d)	Cooling mode	Shank type	Type	Basic dimension(mm)					Suitable for thread		Grade
mm	inch	Fraction					Shank diameter	Overall length	Flute length	Recommended drilling depth	Shank length	cutting taps / tread milling cutters	forming taps	
							d2(h6)	l1	l2	l3	l4			KDG3013
12.2	0.4803	--	3	External coolant	Straight shank	GD03-1220	14	107	60	43	45	9/16-12UNC		●
	0.4803	--	5			GD05-1220	14	124	77	60	45			●
	0.4803	--	3	Internal coolant		GD03C-1220	14	107	60	43	45			●
	0.4803	--	5			GD05C-1220	14	124	77	60	45			●
12.25	0.4823	--	3	External coolant		GD03-1225	14	107	60	43	45			●
	0.4823	--	5			GD05-1225	14	124	77	60	45		●	
	0.4823	--	3	Internal coolant		GD03C-1225	14	107	60	43	45			●
	0.4823	--	5			GD05C-1225	14	124	77	60	45		●	
12.304	0.4844	31/64	3	External coolant	GD03-12304	14	107	60	43	45			●	
	0.4844	31/64	5		GD05-12304	14	124	77	60	45		●		
	0.4844	31/64	3	Internal coolant	GD03C-12304	14	107	60	43	45			●	
	0.4844	31/64	5		GD05C-12304	14	124	77	60	45		●		
12.5	0.4921	--	3	External coolant	GD03-1250	14	107	60	43	45	M14×1.5		●	
	0.4921	--	5		GD05-1250	14	124	77	60	45			●	
	0.4921	--	3	Internal coolant	GD03C-1250	14	107	60	43	45			●	
	0.4921	--	5		GD05C-1250	14	124	77	60	45			●	
	0.4921	--	8		GD08C-1250	14	178	133	116	45			○	
12.7	0.5000	1/2	3	External coolant	GD03-1270	14	107	60	43	45			●	
	0.5000	1/2	5		GD05-1270	14	124	77	60	45		●		
	0.5000	1/2	3	Internal coolant	GD03C-1270	14	107	60	43	45			●	
	0.5000	1/2	5		GD05C-1270	14	124	77	60	45		●		
	0.5000	1/2	8		GD08C-1270	14	178	133	116	45		○		
12.75	0.5020	--	3	External coolant	GD03-1275	14	107	60	43	45			●	
	0.5020	--	5		GD05-1275	14	124	77	60	45		●		
	0.5020	--	3	Internal coolant	GD03C-1275	14	107	60	43	45			●	
	0.5020	--	5		GD05C-1275	14	124	77	60	45		●		

● Stock available ○ Make-to-order

Drill diameter d ₁ (m ₇)			Drilling depth (l/d)	Cooling mode	Shank type	Type	Basic dimension(mm)					Suitable for thread		Grade		
mm	inch	Fraction					Shank diameter d ₂ (h ₆)	Overall length l ₁	Flute length l ₂	Recommended drilling depth l ₃	Shank length l ₄	cutting taps / tread milling cutters	forming taps			
12.8	0.5039	--	3	External coolant	Straight shank	GD03-1280	14	107	60	43	45	9/16-18UNF		●		
	0.5039	--	5			GD05-1280	14	124	77	60	45			●		
	0.5039	--	3	Internal coolant		GD03C-1280	14	107	60	43	45			●		
	0.5039	--	5			GD05C-1280	14	124	77	60	45			●		
	0.5039	--	8			GD08C-1280	14	178	133	116	45			○		
12.9	0.5079	--	3	External coolant		GD03-1290	14	107	60	43	45			9/16-18UNF		●
	0.5079	--	5			GD05-1290	14	124	77	60	45					●
	0.5079	--	3	Internal coolant		GD03C-1290	14	107	60	43	45					●
	0.5079	--	5			GD05C-1290	14	124	77	60	45					●
13.0	0.5118	--	3	External coolant		GD03-1300	14	107	60	43	45			9/16-18UNF		●
	0.5118	--	5		GD05-1300	14	124	77	60	45	●					
	0.5118	--	3	Internal coolant	GD03C-1300	14	107	60	43	45	●					
	0.5118	--	5		GD05C-1300	14	124	77	60	45	●					
	0.5118	--	8		GD08C-1300	14	178	133	116	45	○					
13.1	0.5157	--	3	External coolant	GD03-1310	14	107	60	43	45	M14x2		●			
	0.5157	--	5		GD05-1310	14	124	77	60	45			●			
	0.5157	--	3	Internal coolant	GD03C-1310	14	107	60	43	45			●			
	0.5157	--	5		GD05C-1310	14	124	77	60	45			●			
13.35	0.5256	--	3	External coolant	GD03-1335	14	107	60	43	45	M14x1.5	9/16-12UNC	●			
	0.5256	--	5		GD05-1335	14	124	77	60	45			●			
	0.5256	--	3	Internal coolant	GD03C-1335	14	107	60	43	45			●			
	0.5256	--	5		GD05C-1335	14	124	77	60	45			●			
13.5	0.5315	--	3	External coolant	GD03-1350	14	107	60	43	45	5/8-11UNC		●			
	0.5315	--	5		GD05-1350	14	124	77	60	45			●			
	0.5315	--	3	Internal coolant	GD03C-1350	14	107	60	43	45			●			
	0.5315	--	5		GD05C-1350	14	124	77	60	45			●			
	0.5315	--	8		GD08C-1350	14	178	133	116	45			○			
13.65	0.5374	--	3	External coolant	GD03-1365	14	107	60	43	45	9/16-18UNF		●			
	0.5374	--	5		GD05-1365	14	124	77	60	45			●			
	0.5374	--	3	Internal coolant	GD03C-1365	14	107	60	43	45			●			
	0.5374	--	5		GD05C-1365	14	124	77	60	45			●			
13.8	0.5433	--	3	External coolant	GD03-1380	14	107	60	43	45			●			
	0.5433	--	5		GD05-1380	14	124	77	60	45			●			
	0.5433	--	3	Internal coolant	GD03C-1380	14	107	60	43	45			●			
	0.5433	--	5		GD05C-1380	14	124	77	60	45			●			

Note: For drilling depth (l/d) of 8 ,namely GD08C series, tolerance of shank diameter is h₈.

● Stock available ○ Make-to-order

Applicable material table

◎ Very suitable ○ Suitable

Grade	Workpiece material										
	Mild steel HB ≤ 180	Carbon steel, Alloy steel	Pre-hardened steel, Hardened steel			Stainless steel	Cast iron	Nodular cast iron	Aluminum alloy	Copper alloy	Heat resistant alloy
			~40HRC	~50HRC	~60HRC						
KDG3013	○	◎	◎			○	◎	◎			○

GD series universal machining

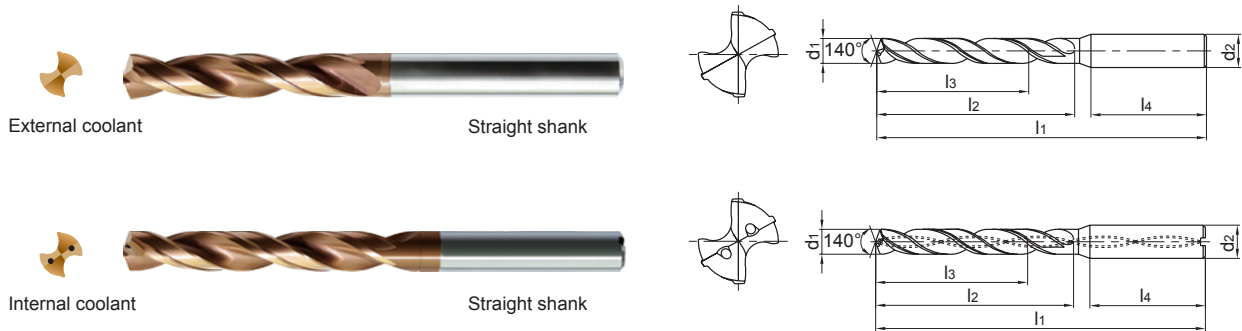

● Suitable for high efficiency drilling in a variety of materials e.g steel, stainless steel, cast iron.

Drill diameter d ₁ (m ₇)			Drilling depth (l/d)	Cooling mode	Shank type	Type	Basic dimension(mm)					Suitable for thread		Grade	
mm	inch	Fraction					Shank diameter	Overall length	Flute length	Recommended drilling depth	Shank length	cutting taps / tread milling cutters	forming taps		
									d ₂ (h ₆)	l ₁	l ₂	l ₃	l ₄		
14.0	0.5512	--	3	External coolant	Straight shank	GD03-1400	14	107	60	43	45	M16×2		●	
	0.5512	--	5			GD05-1400	14	124	77	60	45			●	
	0.5512	--	3	Internal coolant		GD03C-1400	14	107	60	43	45			●	
	0.5512	--	5			GD05C-1400	14	124	77	60	45			●	
	0.5512	--	8			GD08C-1400	14	178	133	116	45			○	
14.25	0.5610	--	3	External coolant		GD03-1425	16	115	65	45	48			●	
	0.5610	--	5			GD05-1425	16	133	83	63	48			●	
	0.5610	--	3	Internal coolant		GD03C-1425	16	115	65	45	48			●	
	0.5610	--	5			GD05C-1425	16	133	83	63	48			●	
	0.5625	9/16	3			GD03-14288	16	115	65	45	48			●	
14.288	0.5625	9/16	5	External coolant	GD05-14288	16	133	83	63	48			●		
	0.5625	9/16	3		Internal coolant	GD03C-14288	16	115	65	45			48	●	
	0.5625	9/16	5	GD05C-14288		16	133	83	63	48			●		
	0.5630	--	3	External coolant	GD03-1430	16	115	65	45	48					●
0.5630	--	5	GD05-1430		16	133	83	63	48	●					
0.5630	--	3	Internal coolant		GD03C-1430	16	115	65	45	48	●				
0.5630	--	5			GD05C-1430	16	133	83	63	48	●				
14.5	0.5709	--	3	External coolant	GD03-1450	16	115	65	45	48	M16×1.5 5/8-18UNF		●		
	0.5709	--	5		GD05-1450	16	133	83	63	48			●		
	0.5709	--	3	Internal coolant	GD03C-1450	16	115	65	45	48			●		
	0.5709	--	5		GD05C-1450	16	133	83	63	48			●		
	0.5709	--	8		GD08C-1450	16	204	152	132	48			○		
14.684	0.5781	37/64	3	External coolant	GD03-14684	16	115	65	45	48			●		
	0.5781	37/64	5		GD05-14684	16	133	83	63	48			●		
	0.5781	37/64	3	Internal coolant	GD03C-14684	16	115	65	45	48			●		
	0.5781	37/64	5		GD05C-14684	16	133	83	63	48			●		
14.75	0.5807	--	3	External coolant	GD03-1475	16	115	65	45	48			●		
	0.5807	--	5		GD05-1475	16	133	83	63	48			●		
	0.5807	--	3	Internal coolant	GD03C-1475	16	115	65	45	48			●		
	0.5807	--	5		GD05C-1475	16	133	83	63	48			●		

● Stock available ○ Make-to-order

Drill diameter d ₁ (m ₇)			Drilling depth (l/d)	Cooling mode	Shank type	Type	Basic dimension(mm)					Suitable for thread		Grade
mm	inch	Fraction					Shank diameter d ₂ (h ₆)	Overall length l ₁	Flute length l ₂	Recommended drilling depth l ₃	Shank length l ₄	cutting taps / tread milling cutters	forming taps	
14.8	0.5827	--	3	External coolant	Straight shank	GD03-1480	16	115	65	45	48	5/8-11UNC	●	
	0.5827	--	5			GD05-1480	16	133	83	63	48		●	
	0.5827	--	3	Internal coolant		GD03C-1480	16	115	65	45	48		●	
	0.5827	--	5			GD05C-1480	16	133	83	63	48		●	
	0.5827	--	8			GD08C-1480	16	204	152	132	48		○	
15.0	0.5906	--	3	External coolant		GD03-1500	16	115	65	45	48	M16×2	●	
	0.5906	--	5			GD05-1500	16	133	83	63	48		●	
	0.5906	--	3	Internal coolant		GD03C-1500	16	115	65	45	48		●	
	0.5906	--	5			GD05C-1500	16	133	83	63	48		●	
	0.5906	--	8			GD08C-1500	16	204	152	132	48		○	
15.1	0.5945	--	3	External coolant	GD03-1510	16	115	65	45	48	M16×2	●		
	0.5945	--	5		GD05-1510	16	133	83	63	48		●		
	0.5945	--	3	Internal coolant	GD03C-1510	16	115	65	45	48		●		
	0.5945	--	5		GD05C-1510	16	133	83	63	48		●		
15.25	0.6004	--	3	External coolant	GD03-1525	16	115	65	45	48	5/8-18UNF	●		
	0.6004	--	5		GD05-1525	16	133	83	63	48		●		
	0.6004	--	3	Internal coolant	GD03C-1525	16	115	65	45	48		●		
	0.6004	--	5		GD05C-1525	16	133	83	63	48		●		
15.35	0.6043	--	3	External coolant	GD03-1535	16	115	65	45	48	M16×1.5	●		
	0.6043	--	5		GD05-1535	16	133	83	63	48		●		
	0.6043	--	3	Internal coolant	GD03C-1535	16	115	65	45	48		●		
	0.6043	--	5		GD05C-1535	16	133	83	63	48		●		
15.5	0.6102	--	3	External coolant	GD03-1550	16	115	65	45	48	M18×2.5	●		
	0.6102	--	5		GD05-1550	16	133	83	63	48		●		
	0.6102	--	3	Internal coolant	GD03C-1550	16	115	65	45	48		●		
	0.6102	--	5		GD05C-1550	16	133	83	63	48		●		
	0.6102	--	8		GD08C-1550	16	204	152	132	48		○		
15.8	0.6220	--	3	External coolant	GD03-1580	16	115	65	45	48	M18×2.5	●		
	0.6220	--	5		GD05-1580	16	133	83	63	48		●		
	0.6220	--	3	Internal coolant	GD03C-1580	16	115	65	45	48		●		
	0.6220	--	5		GD05C-1580	16	133	83	63	48		●		
15.875	0.6250	5/8	3	External coolant	GD03-15875	16	115	65	45	48	M18×2.5	●		
	0.6250	5/8	5		GD05-15875	16	133	83	63	48		●		
	0.6250	5/8	3	Internal coolant	GD03C-15875	16	115	65	45	48		●		
	0.6250	5/8	5		GD05C-15875	16	133	83	63	48		●		

Note: For drilling depth (l/d) of 8 ,namely GD08C series, tolerance of shank diameter is h₈.

● Stock available ○ Make-to-order

▶▶ Applicable material table

◎ Very suitable ○ Suitable

Grade	Workpiece material										
	Mild steel HB ≤ 180	Carbon steel, Alloy steel	Pre-hardened steel, Hardened steel			Stainless steel	Cast iron	Nodular cast iron	Aluminum alloy	Copper alloy	Heat resistant alloy
			~40HRC	~50HRC	~60HRC						
KDG3013	○	◎	◎			○	◎	◎			○

GD series universal machining

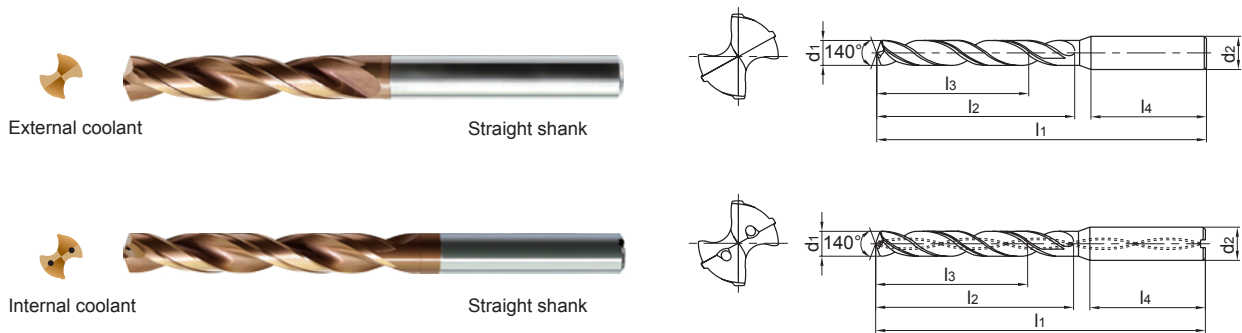

● Suitable for high efficiency drilling in a variety of materials e.g steel, stainless steel, cast iron.

Drill diameter d ₁ (m7)			Drilling depth (l/d)	Cooling mode	Shank type	Type	Basic dimension(mm)					Suitable for thread		Grade
mm	inch	Fraction					Shank diameter d ₂ (h6)	Overall length l ₁	Flute length l ₂	Recommended drilling depth l ₃	Shank length l ₄	cutting taps / tread milling cutters	forming taps	
16.0	0.6299	--	3	External coolant	Straight shank	GD03-1600	16	115	65	45	48	M18×2		●
	0.6299	--	5			GD05-1600	16	133	83	63	48			●
	0.6299	--	3	Internal coolant		GD03C-1600	16	115	65	45	48			●
	0.6299	--	5			GD05C-1600	16	133	83	63	48			●
	0.6299	--	8			GD08C-1600	16	204	152	132	48			○
16.5	0.6496	--	3	External coolant		GD03-1650	18	123	73	51	48	3/4-10UNC		●
	0.6496	--	5			GD05-1650	18	143	93	71	48			●
	0.6496	--	3	Internal coolant		GD03C-1650	18	123	73	51	48			●
	0.6496	--	5			GD05C-1650	18	143	93	71	48			●
	0.6496	--	8			GD08C-1650	18	223	171	149	48			○
16.75	0.6594	--	3	External coolant	GD03-1675	18	123	73	51	48		●		
	0.6594	--	5		GD05-1675	18	143	93	71	48		●		
	0.6594	--	3	Internal coolant	GD03C-1675	18	123	73	51	48		●		
	0.6594	--	5		GD05C-1675	18	143	93	71	48		●		
16.8	0.6614	--	3	External coolant	GD03-1680	18	123	73	51	48	M18×2.5		●	
	0.6614	--	5		GD05-1680	18	143	93	71	48			●	
	0.6614	--	3	Internal coolant	GD03C-1680	18	123	73	51	48			●	
	0.6614	--	5		GD05C-1680	18	143	93	71	48			●	
17.0	0.6693	--	3	External coolant	GD03-1700	18	123	73	51	48		●		
	0.6693	--	5		GD05-1700	18	143	93	71	48		●		
	0.6693	--	3	Internal coolant	GD03C-1700	18	123	73	51	48		●		
	0.6693	--	5		GD05C-1700	18	143	93	71	48		●		
	0.6693	--	8		GD08C-1700	18	223	171	149	48		○		
17.463	0.6875	11/16	3	External coolant	GD03-17463	18	123	73	51	48		●		
	0.6875	11/16	5		GD05-17463	18	143	93	71	48		●		
	0.6875	11/16	3	Internal coolant	GD03C-17463	18	123	73	51	48		●		
	0.6875	11/16	5		GD05C-17463	18	143	93	71	48		●		

● Stock available ○ Make-to-order

Drill diameter d ₁ (m7)			Drilling depth (l/d)	Cooling mode	Shank type	Type	Basic dimension(mm)					Suitable for thread		Grade
mm	inch	Fraction					Shank diameter d ₂ (h ₆)	Overall length l ₁	Flute length l ₂	Recommended drilling depth l ₃	Shank length l ₄	cutting taps / tread milling cutters	forming taps	
17.5	0.6890	--	3	External coolant	Straight shank	GD03-1750	18	123	73	51	48	M20×2.5 3/4-16UNF	●	
	0.6890	--	5			GD05-1750	18	143	93	71	48			
	0.6890	--	3	Internal coolant		GD03C-1750	18	123	73	51	48			
	0.6890	--	5			GD05C-1750	18	143	93	71	48			
	0.6890	--	8			GD08C-1750	18	223	171	149	48			
17.8	0.7008	--	3	External coolant		GD03-1780	18	123	73	51	48	3/4-10UNC		●
	0.7008	--	5			GD05-1780	18	143	93	71	48			
	0.7008	--	3	Internal coolant		GD03C-1780	18	123	73	51	48			
	0.7008	--	5			GD05C-1780	18	143	93	71	48			
17.9	0.7047	--	3	External coolant		GD03-1790	18	123	73	51	48			M20×2
	0.7047	--	5		GD05-1790	18	143	93	71	48				
	0.7047	--	3	Internal coolant	GD03C-1790	18	123	73	51	48				
	0.7047	--	5		GD05C-1790	18	143	93	71	48				
18.0	0.7087	--	3	External coolant	GD03-1800	18	123	73	51	48	3/4-16UNF	●		
	0.7087	--	5		GD05-1800	18	143	93	71	48				
	0.7087	--	3	Internal coolant	GD03C-1800	18	123	73	51	48				
	0.7087	--	5		GD05C-1800	18	143	93	71	48				
	0.7087	--	8		GD08C-1800	18	223	171	149	48				
18.3	0.7205	--	3	External coolant	GD03-1830	20	131	79	55	50	3/4-16UNF	●		
	0.7205	--	5		GD05-1830	20	153	101	77	50				
	0.7205	--	3	Internal coolant	GD03C-1830	20	131	79	55	50				
	0.7205	--	5		GD05C-1830	20	153	101	77	50				
18.5	0.7283	--	3	External coolant	GD03-1850	20	131	79	55	50	M20×2.5	●		
	0.7283	--	5		GD05-1850	20	153	101	77	50				
	0.7283	--	3	Internal coolant	GD03C-1850	20	131	79	55	50				
	0.7283	--	5		GD05C-1850	20	153	101	77	50				
18.8	0.7402	--	3	External coolant	GD03-1880	20	131	79	55	50	M20×2.5	●		
	0.7402	--	5		GD05-1880	20	153	101	77	50				
	0.7402	--	3	Internal coolant	GD03C-1880	20	131	79	55	50				
	0.7402	--	5		GD05C-1880	20	153	101	77	50				

Note: For drilling depth (l/d) of 8 ,namely GD08C series, tolerance of shank diameter is h₅.

● Stock available ○ Make-to-order



▶▶ Applicable material table

◎ Very suitable ○ Suitable

Grade	Workpiece material										
	Mild steel HB ≤ 180	Carbon steel, Alloy steel	Pre-hardened steel, Hardened steel			Stainless steel	Cast iron	Nodular cast iron	Aluminum alloy	Copper alloy	Heat resistant alloy
			~40HRC	~50HRC	~60HRC						
KDG3013	○	◎	◎			○	◎	◎			○

GD series universal machining

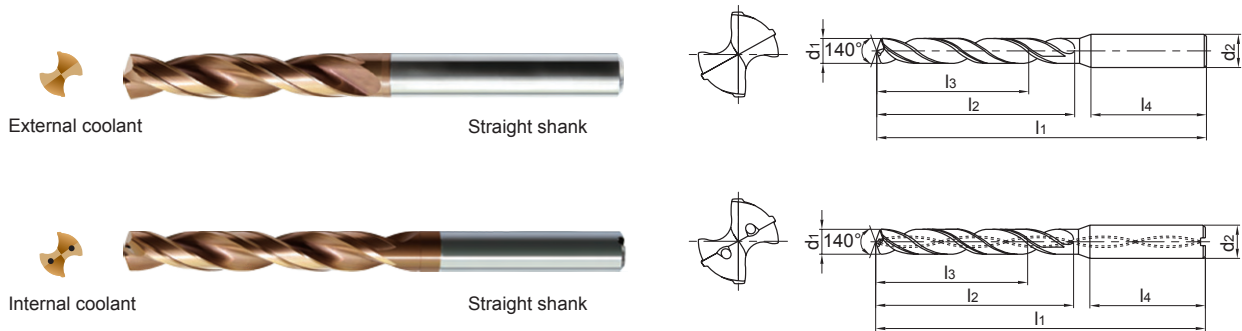

● Suitable for high efficiency drilling in a variety of materials e.g steel, stainless steel, cast iron.

Drill diameter d ₁ (m ₇)			Drilling depth (l/d)	Cooling mode	Shank type	Type	Basic dimension(mm)					Suitable for thread		Grade
mm	inch	Fraction					Shank diameter	Overall length	Flute length	Recommended drilling depth	Shank length	cutting taps / tread milling cutters	forming taps	
							d ₂ (h ₆)	l ₁	l ₂	l ₃	l ₄			KDG3013
19.0	0.7480	--	3	External coolant	Straight shank	GD03-1900	20	131	79	55	50	M22×2.5 7/8-9UNC		●
	0.7480	--	5			GD05-1900	20	153	101	77	50			●
	0.7480	--	3	Internal coolant		GD03C-1900	20	131	79	55	50			●
	0.7480	--	5			GD05C-1900	20	153	101	77	50			●
19.05	0.7500	3/4	3	External coolant		GD03-1905	20	131	79	55	50			●
	0.7500	3/4	5			GD05-1905	20	153	101	77	50			●
	0.7500	3/4	3	Internal coolant		GD03C-1905	20	131	79	55	50			●
	0.7500	3/4	5			GD05C-1905	20	153	101	77	50			●
19.5	0.7677	--	3	External coolant	GD03-1950	20	131	79	55	50	●			
	0.7677	--	5		GD05-1950	20	153	101	77	50	●			
	0.7677	--	3	Internal coolant	GD03C-1950	20	131	79	55	50	●			
	0.7677	--	5		GD05C-1950	20	153	101	77	50	●			
19.8	0.7795	--	3	External coolant	GD03-1980	20	131	79	55	50	●			
	0.7795	--	5		GD05-1980	20	153	101	77	50	●			
	0.7795	--	3	Internal coolant	GD03C-1980	20	131	79	55	50	●			
	0.7795	--	5		GD05C-1980	20	153	101	77	50	●			
20.0	0.7874	--	3	External coolant	GD03-2000	20	131	79	55	50	M22×2	●		
	0.7874	--	5		GD05-2000	20	153	101	77	50		●		
	0.7874	--	3	Internal coolant	GD03C-2000	20	131	79	55	50		●		
	0.7874	--	5		GD05C-2000	20	153	101	77	50		●		

Note: For drilling depth (l/d) of 8, namely GD08C series, tolerance of shank diameter is h₈.

● Stock available ○ Make-to-order

Applicable material table

◎ Very suitable ○ Suitable

Grade	Workpiece material										
	Mild steel HB ≤ 180	Carbon steel, Alloy steel	Pre-hardened steel, Hardened steel			Stainless steel	Cast iron	Nodular cast iron	Aluminum alloy	Copper alloy	Heat resistant alloy
			~40HRC	~50HRC	~60HRC						
KDG3013	○	◎	◎			○	◎	◎			○



1588SL series

Deep Hole Twist Drills

Optimized tool structure achieved through cutting analysis simulations.

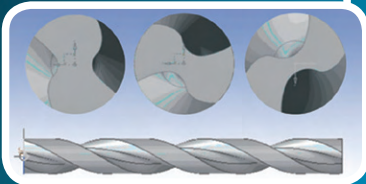
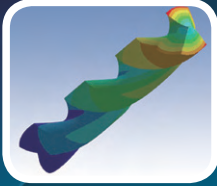

Modified parameter design of the the helical flute,provide good rigidity and chip removal capabilities.

Unique cutting edge design provide high versatility for the tool. Great chip breaking capability for sticky and softer materials.

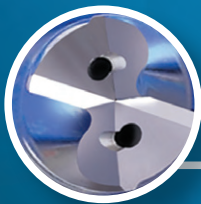

Unique double guiding margin achieves more stable and reliable machining.



Special nano structure coating with improved self lubricating capability and superb wear resistance.

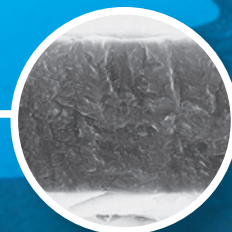

1588SL Series Deep Hole Twist Drills

1588SL Series Deep Hole Twist Drills

Outstanding chip breaking capability



Work piece: crank shaft
 Work piece material: 5140
 Machining area: inclined oil hole
 Tool type: 1588SL20C-0690/KDG303
 Cutting parameters: SFM=260~395ft/min
 $f_r=0.007874$ in/r
 Cooling system: water-soluble liquid
 Drilling depth: 4.134in



Extremely high efficiency and long tool life

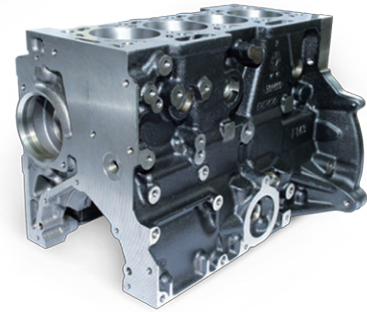

Work piece: cylinder
 Work material: NO.45
 Machined area: crank shaft joint surface drilling
 Drilling depth: 1.181in
 Tool type: 1588SL12C-0850/KDG303
 Recommend parameters: SFM=260ft/min
 $f_r=0.011811$ in/r
 Cooling system: water-soluble liquid

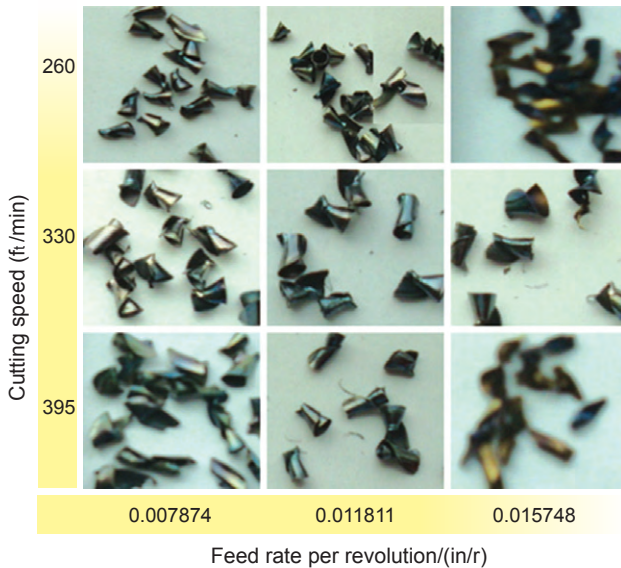

Good chip breaking capability and stable machining with different cutting speed and feed rate.

Comparison of tool life(number of machined holes)

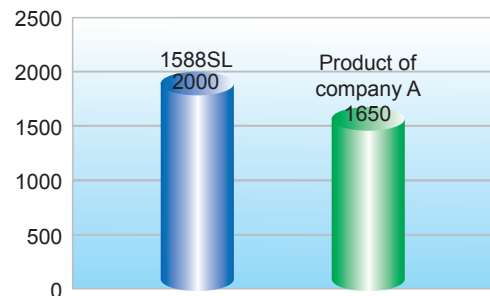

Comparison of tool life(tool wear)

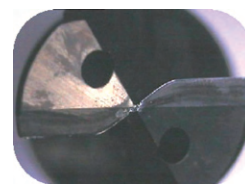

1588SL(regular wear)

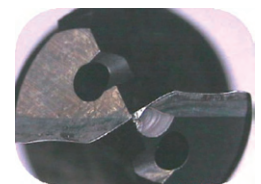

Product of company A(falling)

Superior cutting performance

Tool type: 1588SL12C-0850/KDG303
 Feed rate: 0.007874in/r Drilling depth: 2.835in
 Work material: 4140
 Cooling system: Emulsified liquid
 Cutting speed: 260f/min
 Machine equipment: Vertical machining center

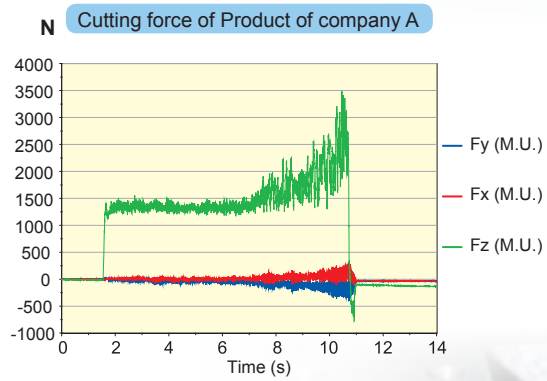
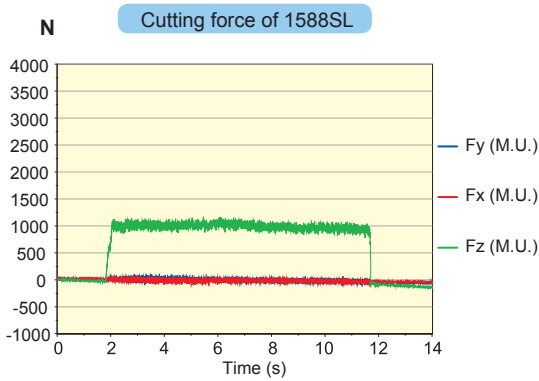

Machining precision stability

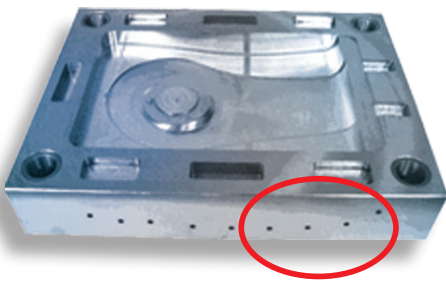

Workpiece: Die
 Machined materials: P20
 Machined area: Hole of sidewall
 Drilling depth: 2.756in
 Tool type: 1588SL12C-0600/KDG303
 Recommended parameters: SFM=280f/min, $f_r=0.007874$ in/r
 Cooling system: Water-soluble liquid

Comparison of Machined Hole's Accuracy

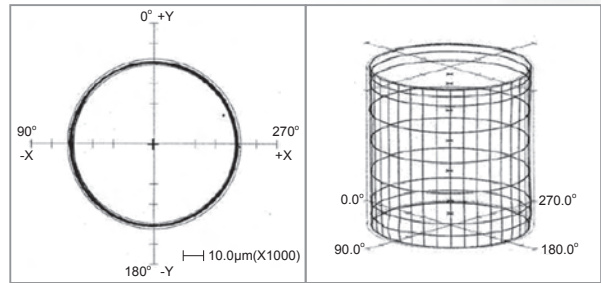

1588SL

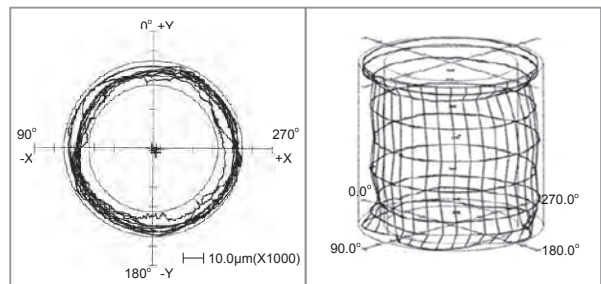

Product of company A

SL Series Deep Hole Machining



Internal Coolant

Straight Shank

- d₁ tolerance 12D m7
d₁ tolerance 20D/30D h7
- Suitable for deep-hole drilling of steel, cast iron etc.

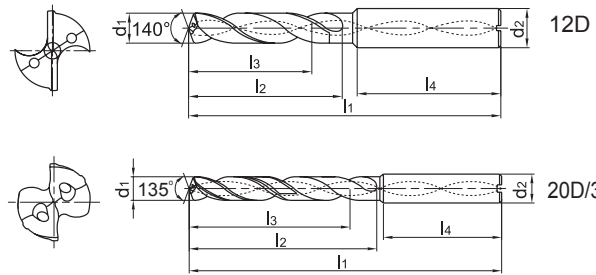

Drill diameter			Drilling depth (l/d)	Type	Basic dimension(mm)				
mm	inch	Fraction			d ₂ (h ₅)	l ₁	l ₂	l ₃	l ₄
3.0	.1181	--	12	1588SL12C-0300	6	90	50	40	36
		--	20	1588SL20C-0300	6	110	70	62	36
		--	30	1588SL30C-0300	6	140	100	92	36
3.1	.1220	--	12	1588SL12C-0310	6	90	50	40	36
		--	20	1588SL20C-0310	6	123	83	72	36
		--	30	1588SL30C-0310	6	160	120	108	36
3.175	.1250	1/8	12	1588SL12C-03175	6	90	50	40	36
		1/8	20	1588SL20C-03175	6	123	83	72	36
		1/8	30	1588SL30C-03175	6	160	120	108	36
3.2	.1260	--	12	1588SL12C-0320	6	90	50	40	36
		--	20	1588SL20C-0320	6	123	83	72	36
		--	30	1588SL30C-0320	6	160	120	108	36
3.3	.1299	--	12	1588SL12C-0330	6	90	50	40	36
		--	20	1588SL20C-0330	6	123	83	72	36
		--	30	1588SL30C-0330	6	160	120	108	36
3.4	.1339	--	12	1588SL12C-0340	6	90	50	40	36
		--	20	1588SL20C-0340	6	123	83	72	36
		--	30	1588SL30C-0340	6	160	120	108	36
3.5	.1378	--	12	1588SL12C-0350	6	90	50	40	36
		--	20	1588SL20C-0350	6	123	83	72	36
		--	30	1588SL30C-0350	6	160	120	108	36
3.6	.1417	--	12	1588SL12C-0360	6	90	50	40	36
		--	20	1588SL20C-0360	6	136	96	84	36
		--	30	1588SL30C-0360	6	176	136	124	36
3.7	.1457	--	12	1588SL12C-0370	6	90	50	46	36
		--	20	1588SL20C-0370	6	136	96	84	36
		--	30	1588SL30C-0370	6	176	136	124	36
3.8	.1496	--	12	1588SL12C-0380	6	90	50	46	36
		--	20	1588SL20C-0380	6	136	96	84	36
		--	30	1588SL30C-0380	6	176	136	124	36
3.9	.1535	--	12	1588SL12C-0390	6	90	50	46	36
		--	20	1588SL20C-0390	6	136	96	84	36
		--	30	1588SL30C-0390	6	176	136	124	36

Drill diameter			Drilling depth (l/d)	Type	Basic dimension(mm)				
mm	inch	Fraction			d ₂ (h ₅)	l ₁	l ₂	l ₃	l ₄
3.970	.1563	5/32	12	1588SL12C-03970	6	90	50	46	36
		5/32	20	1588SL20C-03970	6	136	96	84	36
		5/32	30	1588SL30C-03970	6	176	136	124	36
4.0	.1575	--	12	1588SL12C-0400	6	102	64	56	36
		--	20	1588SL20C-0400	6	136	96	84	36
		--	30	1588SL30C-0400	6	176	136	124	36
4.1	.1614	--	12	1588SL12C-0410	6	102	64	56	36
		--	20	1588SL20C-0410	6	148	108	96	36
		--	30	1588SL30C-0410	6	192	152	140	36
4.2	.1654	--	12	1588SL12C-0420	6	102	64	56	36
		--	20	1588SL20C-0420	6	148	108	96	36
		--	30	1588SL30C-0420	6	192	152	140	36
4.3	.1693	--	12	1588SL12C-0430	6	102	64	56	36
		--	20	1588SL20C-0430	6	148	108	96	36
		--	30	1588SL30C-0430	6	192	152	140	36
4.4	.1732	--	12	1588SL12C-0440	6	102	64	56	36
		--	20	1588SL20C-0440	6	148	108	96	36
		--	30	1588SL30C-0440	6	192	152	140	36
4.5	.1772	--	12	1588SL12C-0450	6	102	64	56	36
		--	20	1588SL20C-0450	6	148	108	96	36
		--	30	1588SL30C-0450	6	192	152	140	36
4.6	.1811	--	12	1588SL12C-0460	6	102	64	56	36
		--	20	1588SL20C-0460	6	158	118	106	36
		--	30	1588SL30C-0460	6	208	168	156	36
4.7	.1850	--	12	1588SL12C-0470	6	102	64	56	36
		--	20	1588SL20C-0470	6	158	118	106	36
		--	30	1588SL30C-0470	6	208	168	156	36
4.763	.1875	3/16	12	1588SL12C-04763	6	102	64	56	36
		3/16	20	1588SL20C-04763	6	158	118	106	36
		3/16	30	1588SL30C-04763	6	208	168	156	36
4.8	.1890	--	12	1588SL12C-0480	6	102	64	56	36
		--	20	1588SL20C-0480	6	158	118	106	36
		--	30	1588SL30C-0480	6	208	168	156	36



SL Series Deep Hole Machining



- d₁ tolerance 12D m7
d₁ tolerance 20D/30D h7
- Suitable for deep-hole drilling of steel, cast iron etc.

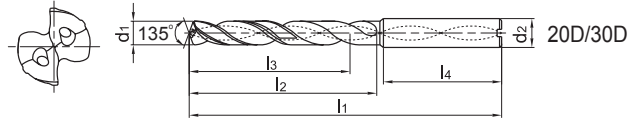
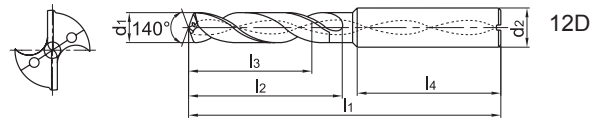

Drill diameter			Drilling depth (l/d)	Type	Basic dimension(mm)														
mm	inch	Fraction			d ₂ (h ₈)	l ₁	l ₂	l ₃	l ₄										
4.9	.1929	--	12	1588SL12C-0490	6	102	64	56	36	5.9	.2323	--	12	1588SL12C-0590	6	116	78	72	36
		--	20	1588SL20C-0490	6	158	118	106	36			--	20	1588SL20C-0590	6	180	140	126	36
		--	30	1588SL30C-0490	6	208	168	156	36			--	30	1588SL30C-0590	6	240	200	182	36
5.0	.1969	--	12	1588SL12C-0500	6	116	78	72	36	6.0	.2362	--	12	1588SL12C-0600	6	116	78	72	36
		--	20	1588SL20C-0500	6	158	118	106	36			--	20	1588SL20C-0600	6	180	140	126	36
		--	30	1588SL30C-0500	6	208	168	156	36			--	30	1588SL30C-0600	6	240	200	182	36
5.1	.2008	--	12	1588SL12C-0510	6	116	78	72	36	6.1	.2402	--	12	1588SL12C-0610	8	131	93	84	36
		--	20	1588SL20C-0510	6	168	128	116	36			--	20	1588SL20C-0610	8	192	150	132	36
		--	30	1588SL30C-0510	6	228	188	170	36			--	30	1588SL30C-0610	8	260	220	202	36
5.2	.2047	--	12	1588SL12C-0520	6	116	78	72	36	6.2	.2441	--	12	1588SL12C-0620	8	131	93	84	36
		--	20	1588SL20C-0520	6	168	128	116	36			--	20	1588SL20C-0620	8	192	150	132	36
		--	30	1588SL30C-0520	6	228	188	170	36			--	30	1588SL30C-0620	8	260	220	202	36
5.3	.2087	--	12	1588SL12C-0530	6	116	78	72	36	6.3	.2480	--	12	1588SL12C-0630	8	131	93	84	36
		--	20	1588SL20C-0530	6	168	128	116	36			--	20	1588SL20C-0630	8	192	150	132	36
		--	30	1588SL30C-0530	6	228	188	170	36			--	30	1588SL30C-0630	8	260	220	202	36
5.4	.2126	--	12	1588SL12C-0540	6	116	78	72	36	6.350	.2500	1/4	12	1588SL12C-06350	8	131	93	84	36
		--	20	1588SL20C-0540	6	168	128	116	36			1/4	20	1588SL20C-06350	8	192	150	132	36
		--	30	1588SL30C-0540	6	228	188	170	36			1/4	30	1588SL30C-06350	8	260	220	202	36
5.5	.2165	--	12	1588SL12C-0550	6	116	78	72	36	6.4	.2520	--	12	1588SL12C-0640	8	131	93	84	36
		--	20	1588SL20C-0550	6	168	128	116	36			--	20	1588SL20C-0640	8	192	150	132	36
		--	30	1588SL30C-0550	6	228	188	170	36			--	30	1588SL30C-0640	8	260	220	202	36
5.558	.2188	7/32	12	1588SL12C-05558	6	116	78	72	36	6.5	.2559	--	12	1588SL12C-0650	8	131	93	84	36
		7/32	20	1588SL20C-05558	6	180	140	126	36			--	20	1588SL20C-0650	8	192	150	132	36
		7/32	30	1588SL30C-05558	6	240	200	182	36			--	30	1588SL30C-0650	8	260	220	202	36
5.6	.2205	--	12	1588SL12C-0560	6	116	78	72	36	6.6	.2598	--	12	1588SL12C-0660	8	131	93	84	36
		--	20	1588SL20C-0560	6	180	140	126	36			--	20	1588SL20C-0660	8	202	162	144	36
		--	30	1588SL30C-0560	6	240	200	182	36			--	30	1588SL30C-0660	8	272	232	214	36
5.7	.2244	--	12	1588SL12C-0570	6	116	78	72	36	6.7	.2638	--	12	1588SL12C-0670	8	131	93	84	36
		--	20	1588SL20C-0570	6	180	140	126	36			--	20	1588SL20C-0670	8	202	162	144	36
		--	30	1588SL30C-0570	6	240	200	182	36			--	30	1588SL30C-0670	8	272	232	214	36
5.8	.2283	--	12	1588SL12C-0580	6	116	78	72	36	6.746	.2656	17/64	12	1588SL12C-06746	8	131	93	84	36
		--	20	1588SL20C-0580	6	180	140	126	36			17/64	20	1588SL20C-06746	8	202	162	144	36
		--	30	1588SL30C-0580	6	240	200	182	36			17/64	30	1588SL30C-06746	8	272	232	214	36

Drill diameter			Drilling depth (l/d)	Type	Basic dimension(mm)				
mm	inch	Fraction			d2(hs)	l1	l2	l3	l4
6.8	.2677	--	12	1588SL12C-0680	8	131	93	84	36
		--	20	1588SL20C-0680	8	202	162	144	36
		--	30	1588SL30C-0680	8	272	232	214	36
6.9	.2717	--	12	1588SL12C-0690	8	131	93	84	36
		--	20	1588SL20C-0690	8	202	162	144	36
		--	30	1588SL30C-0690	8	272	232	214	36
7.0	.2756	--	12	1588SL12C-0700	8	131	93	84	36
		--	20	1588SL20C-0700	8	202	162	144	36
		--	30	1588SL30C-0700	8	272	232	214	36
7.1	.2795	--	12	1588SL12C-0710	8	146	108	96	36
		--	20	1588SL20C-0710	8	213	173	155	36
		--	30	1588SL30C-0710	8	290	250	232	36
7.145	.2813	9/32	12	1588SL12C-07145	8	146	108	96	36
		9/32	20	1588SL20C-07145	8	213	173	155	36
		9/32	30	1588SL30C-07145	8	290	250	232	36
7.2	.2835	--	12	1588SL12C-0720	8	146	108	96	36
		--	20	1588SL20C-0720	8	213	173	155	36
		--	30	1588SL30C-0720	8	290	250	232	36
7.3	.2874	--	12	1588SL12C-0730	8	146	108	96	36
		--	20	1588SL20C-0730	8	213	173	155	36
		--	30	1588SL30C-0730	8	290	250	232	36
7.4	.2913	--	12	1588SL12C-0740	8	146	108	96	36
		--	20	1588SL20C-0740	8	213	173	155	36
		--	30	1588SL30C-0740	8	290	250	232	36
7.5	.2953	--	12	1588SL12C-0750	8	146	108	96	36
		--	20	1588SL20C-0750	8	213	173	155	36
		--	30	1588SL30C-0750	8	290	250	232	36
7.541	.2969	19/64	12	1588SL12C-07541	8	146	108	96	36
		19/64	20	1588SL20C-07541	8	223	183	165	36
		19/64	30	1588SL30C-07541	8	305	265	246	36
7.6	.2992	--	12	1588SL12C-0760	8	146	108	96	36
		--	20	1588SL20C-0760	8	223	183	165	36
		--	30	1588SL30C-0760	8	305	265	246	36
7.7	.3031	--	12	1588SL12C-0770	8	146	108	96	36
		--	20	1588SL20C-0770	8	223	183	165	36
		--	30	1588SL30C-0770	8	305	265	246	36
7.8	.3071	--	12	1588SL12C-0780	8	146	108	96	36
		--	20	1588SL20C-0780	8	223	183	165	36
		--	30	1588SL30C-0780	8	305	265	246	36
7.9	.3110	--	12	1588SL12C-0790	8	146	108	96	36
		--	20	1588SL20C-0790	8	223	183	165	36
		--	30	1588SL30C-0790	8	305	265	246	36

Drill diameter			Drilling depth (l/d)	Type	Basic dimension(mm)				
mm	inch	Fraction			d2(hs)	l1	l2	l3	l4
7.938	.3125	5/16	12	1588SL12C-07938	8	146	108	96	36
		5/16	20	1588SL20C-07938	8	223	183	165	36
		5/16	30	1588SL30C-07938	8	305	265	246	36
8.0	.3150	--	12	1588SL12C-0800	8	146	108	96	36
		--	20	1588SL20C-0800	8	223	183	165	36
		--	30	1588SL30C-0800	8	305	265	246	36
8.1	.3189	--	12	1588SL12C-0810	10	162	120	108	40
		--	20	1588SL20C-0810	10	239	195	176	40
		--	30	1588SL30C-0810	10	330	285	265	40
8.2	.3228	--	12	1588SL12C-0820	10	162	120	108	40
		--	20	1588SL20C-0820	10	239	195	176	40
		--	30	1588SL30C-0820	10	330	285	265	40
8.3	.3268	--	12	1588SL12C-0830	10	162	120	108	40
		--	20	1588SL20C-0830	10	239	195	176	40
		--	30	1588SL30C-0830	10	330	285	265	40
8.334	.3281	21/64	12	1588SL12C-08334	10	162	120	108	40
		21/64	20	1588SL20C-08334	10	239	195	176	40
		21/64	30	1588SL30C-08334	10	330	285	265	40
8.4	.3307	--	12	1588SL12C-0840	10	162	120	108	40
		--	20	1588SL20C-0840	10	239	195	176	40
		--	30	1588SL30C-0840	10	330	285	265	40
8.5	.3346	--	12	1588SL12C-0850	10	162	120	108	40
		--	20	1588SL20C-0850	10	239	195	176	40
		--	30	1588SL30C-0850	10	330	285	265	40
8.6	.3386	--	12	1588SL12C-0860	10	162	120	108	40
		--	20	1588SL20C-0860	10	249	205	186	40
		--	30	1588SL30C-0860	10	340	295	275	40
8.7	.3425	--	12	1588SL12C-0870	10	162	120	108	40
		--	20	1588SL20C-0870	10	249	205	186	40
		--	30	1588SL30C-0870	10	340	295	275	40
8.733	.3438	11/32	12	1588SL12C-08733	10	162	120	108	40
		11/32	20	1588SL20C-08733	10	249	205	186	40
		11/32	30	1588SL30C-08733	10	340	295	275	40
8.8	.3465	--	12	1588SL12C-0880	10	162	120	108	40
		--	20	1588SL20C-0880	10	249	205	186	40
		--	30	1588SL30C-0880	10	340	295	275	40
8.9	.3504	--	12	1588SL12C-0890	10	162	120	108	40
		--	20	1588SL20C-0890	10	249	205	186	40
		--	30	1588SL30C-0890	10	340	295	275	40
9.0	.3543	--	12	1588SL12C-0900	10	162	120	108	40
		--	20	1588SL20C-0900	10	249	205	186	40
		--	30	1588SL30C-0900	10	340	295	275	40



SL Series Deep Hole Machining



Internal Coolant

Straight Shank

- d₁ tolerance 12D m7
d₁ tolerance 20D/30D h7
- Suitable for deep-hole drilling of steel, cast iron etc.

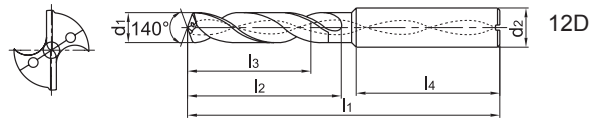

12D

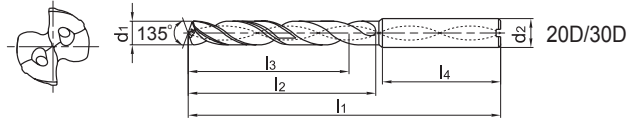

20D/30D

Drill diameter			Drilling depth (l/d)	Type	Basic dimension(mm)				
mm	inch	Fraction			d ₂ (h ₅)	l ₁	l ₂	l ₃	l ₄
9.1	.3583	--	12	1588SL12C-0910	10	174	132	120	40
		--	20	1588SL20C-0910	10	262	218	196	40
		--	30	1588SL30C-0910	10	360	315	292	40
9.129	.3594	23/64	12	1588SL12C-09129	10	174	132	120	40
		23/64	20	1588SL20C-09129	10	262	218	196	40
		23/64	30	1588SL30C-09129	10	360	315	292	40
9.2	.3622	--	12	1588SL12C-0920	10	174	132	120	40
		--	20	1588SL20C-0920	10	262	218	196	40
		--	30	1588SL30C-0920	10	360	315	292	40
9.3	.3661	--	12	1588SL12C-0930	10	174	132	120	40
		--	20	1588SL20C-0930	10	262	218	196	40
		--	30	1588SL30C-0930	10	360	315	292	40
9.4	.3701	--	12	1588SL12C-0940	10	174	132	120	40
		--	20	1588SL20C-0940	10	262	218	196	40
		--	30	1588SL30C-0940	10	360	315	292	40
9.5	.3740	--	12	1588SL12C-0950	10	174	132	120	40
		--	20	1588SL20C-0950	10	262	218	196	40
		--	30	1588SL30C-0950	10	360	315	292	40
9.525	.3750	3/8	12	1588SL12C-09525	10	174	132	120	40
		3/8	20	1588SL20C-09525	10	272	228	206	40
		3/8	30	1588SL30C-09525	10	372	328	305	40
9.6	.3780	--	12	1588SL12C-0960	10	174	132	120	40
		--	20	1588SL20C-0960	10	272	228	206	40
		--	30	1588SL30C-0960	10	372	328	305	40
9.7	.3819	--	12	1588SL12C-0970	10	174	132	120	40
		--	20	1588SL20C-0970	10	272	228	206	40
		--	30	1588SL30C-0970	10	372	328	305	40
9.8	.3858	--	12	1588SL12C-0980	10	174	132	120	40
		--	20	1588SL20C-0980	10	272	228	206	40
		--	30	1588SL30C-0980	10	372	328	305	40
9.9	.3898	--	12	1588SL12C-0990	10	174	132	120	40
		--	20	1588SL20C-0990	10	272	228	206	40
		--	30	1588SL30C-0990	10	372	328	305	40

Drill diameter			Drilling depth (l/d)	Type	Basic dimension(mm)				
mm	inch	Fraction			d ₂ (h ₅)	l ₁	l ₂	l ₃	l ₄
9.921	.3906	25/64	12	1588SL12C-09921	10	174	132	120	40
		25/64	20	1588SL20C-09921	10	272	228	206	40
		25/64	30	1588SL30C-09921	10	372	328	305	40
10.0	.3937	--	12	1588SL12C-1000	10	174	132	120	40
		--	20	1588SL20C-1000	10	272	228	206	40
		--	30	1588SL30C-1000	10	372	328	305	40
10.1	.3976	--	12	1588SL12C-1010	12	204	156	144	45
		--	20	1588SL20C-1010	12	292	242	220	45
		--	12	1588SL12C-1020	12	204	156	144	45
10.2	.4016	--	20	1588SL20C-1020	12	292	242	220	45
		--	12	1588SL12C-1030	12	204	156	144	45
		--	20	1588SL20C-1030	12	292	242	220	45
10.3	.4055	--	12	1588SL12C-1030	12	204	156	144	45
		--	20	1588SL20C-1030	12	292	242	220	45
		13/32	12	1588SL12C-10320	12	204	156	144	45
10.320	.4063	13/32	20	1588SL20C-10320	12	292	242	220	45
		--	12	1588SL12C-1040	12	204	156	144	45
10.4	.4094	--	20	1588SL20C-1040	12	292	242	220	45
		--	12	1588SL12C-1050	12	204	156	144	45
10.5	.4134	--	12	1588SL12C-1050	12	204	156	144	45
		--	20	1588SL20C-1050	12	292	242	220	45
10.6	.4173	--	12	1588SL12C-1060	12	204	156	144	45
		--	20	1588SL20C-1060	12	300	250	228	45
10.7	.4213	--	12	1588SL12C-1070	12	204	156	144	45
		--	20	1588SL20C-1070	12	300	250	228	45
10.716	.4219	27/64	12	1588SL12C-10716	12	204	156	144	45
		27/64	20	1588SL20C-10716	12	300	250	228	45
10.8	.4252	--	12	1588SL12C-1080	12	204	156	144	45
		--	20	1588SL20C-1080	12	300	250	228	45
10.9	.4291	--	12	1588SL12C-1090	12	204	156	144	45
		--	20	1588SL20C-1090	12	300	250	228	45
11.0	.4331	--	12	1588SL12C-1100	12	204	156	144	45
		--	20	1588SL20C-1100	12	300	250	228	45
11.1	.4370	--	12	1588SL12C-1110	12	204	156	144	45
		--	20	1588SL20C-1110	12	315	265	240	45
11.113	.4375	7/16	12	1588SL12C-11113	12	204	156	144	45

Drill diameter			Drilling depth (l/d)	Type	Basic dimension(mm)				
mm	inch	Fraction			d2(hs)	l1	l2	l3	l4
11.113	.4375	7/16	20	1588SL20C-11113	12	315	265	240	45
11.2	.4409	--	12	1588SL12C-1120	12	204	156	144	45
		--	20	1588SL20C-1120	12	315	265	240	45
11.3	.4449	--	12	1588SL12C-1130	12	204	156	144	45
		--	20	1588SL20C-1130	12	315	265	240	45
11.4	.4488	--	12	1588SL12C-1140	12	204	156	144	45
		--	20	1588SL20C-1140	12	315	265	240	45
11.5	.4528	--	12	1588SL12C-1150	12	204	156	144	45
		--	20	1588SL20C-1150	12	315	265	240	45
11.6	.4567	--	12	1588SL12C-1160	12	204	156	144	45
		--	20	1588SL20C-1160	12	325	275	250	45
11.7	.4606	--	12	1588SL12C-1170	12	204	156	144	45
		--	20	1588SL20C-1170	12	325	275	250	45
11.8	.4646	--	12	1588SL12C-1180	12	204	156	144	45
		--	20	1588SL20C-1180	12	325	275	250	45
11.9	.4685	--	12	1588SL12C-1190	12	204	156	144	45
		--	20	1588SL20C-1190	12	325	275	250	45
12.0	.4724	--	12	1588SL12C-1200	12	204	156	144	45
		--	20	1588SL20C-1200	12	325	275	250	45
12.304	.4844	31/64	12	1588SL12C-12304	14	230	182	168	45
		31/64	20	1588SL20C-12304	14	325	275	250	45
12.5	.4921	--	12	1588SL12C-1250	14	230	182	168	45
		--	20	1588SL20C-1250	14	325	275	250	45
12.7	.5000	1/2	12	1588SL12C-1270	14	230	182	168	45
		1/2	20	1588SL20C-1270	14	338	290	265	45

Drill diameter			Drilling depth (l/d)	Type	Basic dimension(mm)				
mm	inch	Fraction			d2(hs)	l1	l2	l3	l4
12.8	.5039	--	12	1588SL12C-1280	14	230	182	168	45
13.0	.5118	--	12	1588SL12C-1300	14	230	182	168	45
		--	20	1588SL20C-1300	14	338	290	265	45
13.5	.5315	--	12	1588SL12C-1350	14	230	182	168	45
		--	20	1588SL20C-1350	14	338	290	265	45
14.0	.5512	--	12	1588SL12C-1400	14	230	182	168	45
		--	20	1588SL20C-1400	14	367	318	290	45
14.288	.5625	9/16	12	1588SL12C-14288	16	260	208	194	48
14.5	.5709	--	12	1588SL12C-1450	16	260	208	194	48
14.684	.5781	37/64	12	1588SL12C-14684	16	260	208	194	48
15.0	.5906	--	12	1588SL12C-1500	16	260	208	194	48
15.5	.6102	--	12	1588SL12C-1550	16	260	208	194	48
15.875	.6250	5/8	12	1588SL12C-15875	16	260	208	194	48
16.0	.6299	--	12	1588SL12C-1600	16	260	208	194	48
16.5	.6496	--	12	1588SL12C-1650	18	286	234	218	48
17.0	.6693	--	12	1588SL12C-1700	18	286	234	218	48
17.463	.6875	11/16	12	1588SL12C-17463	18	286	234	218	48
17.5	.6890	--	12	1588SL12C-1750	18	286	234	218	48
18.0	.7087	--	12	1588SL12C-1800	18	286	234	218	48
18.5	.7283	--	12	1588SL12C-1850	20	310	258	240	48
19.0	.7480	--	12	1588SL12C-1900	20	310	258	240	48
19.050	.7500	3/4	12	1588SL12C-19050	20	310	258	240	48
19.5	.7677	--	12	1588SL12C-1950	20	310	258	240	48
20.0	.7874	--	12	1588SL12C-2000	20	310	258	240	48



➤ Applicable Material Table

⊙Very suitable ○Suitable

Grade	Workpiece material										
	Mild steel HB≤180	Carbon steel, Alloy steel	Pre-hardened steel, Hardened steel			Stainless steel	Cast iron	Nodular cast iron	Aluminum alloy	Copper alloy	Heat resistant alloy
			~40HRC	~50HRC	~60HRC						
KDG303	○	⊙	⊙			○	⊙	⊙	○		○

Recommended Machining Method for SL Series Deep Hole Drills

1. Hole-guided Machining

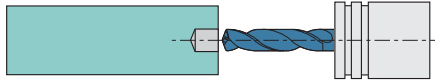

- ◆ The apex angle of drills used for hole-guided machining has to be greater than the apex angle of deep-hole drills.
- ◆ Diameter of drills used for hole-guided machining has to be respectively greater than the diameter of deep-hole drills. Generally the diameter range of deep-hole drills is between 0 and positive 0.1.
- ◆ Generally the depth of pre-drilling hole is 1-3D (D is the diameter of pre-drilling holes). Also, it basically needs to ensure the accuracy of pre-drilling holes at the same time.

3. Deep Hole Machining (Start to Finish)

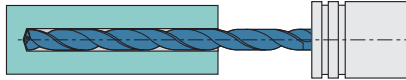

- ◆ Uninterrupted machining with fixed speed and feed rates. (Complete machining in one go, not a "Step-by-Step" machining).

2. Deep Hole Machining (Inserting into the Pre-drilling Holes)

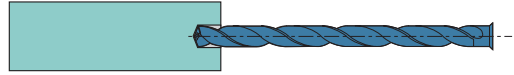

- ◆ Lower speed should be applied in the process of inserting deep-hole drills into the pre-drilling holes.
- ◆ Insert deep hole drill to the location 1-3mm away from the bottom of pre-drilling holes (Please make sure that the parts of drilling point are entirely inserted).

4. Deep Hole Machining (Retract from hole)

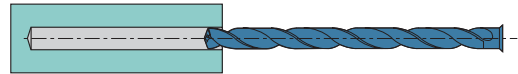

- ◆ At the end of machining, reduce drill speed 1-2mm away from drilled hole's opening.
- ◆ Quickly secedes drill back to the location where machining first started.
- ◆ Apply retraction under the same conditions when inserting pre-drilling holes.

GD series twist drills(external coolant)

3D 5D

workpiece material	Mild steel HB≤180		Carbon steel, alloy steel ~30HRC		Pre-hardened steel ~40HRC		Stainless steel		Cast iron		Nodular cast iron		Heat resistant alloy	
Cutting speed	200~395SFPM		200~395SFPM		135~230SFPM		85~135SFPM		200~395SFPM		165~330SFPM		50~85SFPM	
Diameter (mm)	Rotating speed (r/min)	Feed rate (in/rev)	Rotating speed (r/min)	Feed rate (in/rev)	Rotating speed (r/min)	Feed rate (in/rev)	Rotating speed (r/min)	Feed rate (in/rev)	Rotating speed (r/min)	Feed rate (in/rev)	Rotating speed (r/min)	Feed rate (in/rev)	Rotating speed (r/min)	Feed rate (in/rev)
2	14000	0.0024~0.0031	14000	0.0024~0.0031	9500	0.0024~0.0031	5500	0.0008~0.002	14000	0.0024~0.0031	11000	0.0024~0.0031	3200	0.0008~0.0016
3	9500	0.0035~0.0047	9500	0.0035~0.0047	6300	0.0035~0.0047	3700	0.0012~0.0028	9500	0.0035~0.0047	7400	0.0035~0.0047	2100	0.0012~0.0024
4	7000	0.0039~0.0059	7000	0.0039~0.0059	4700	0.0039~0.0059	2700	0.0016~0.0031	7000	0.0039~0.0059	5600	0.0039~0.0059	1600	0.0016~0.0028
5	5700	0.0047~0.0071	5700	0.0047~0.0071	3800	0.0047~0.0071	2200	0.002~0.0039	5700	0.0047~0.0071	4500	0.0047~0.0071	1250	0.002~0.0035
6	4700	0.0055~0.0079	4700	0.0055~0.0079	3100	0.0055~0.0079	1850	0.0024~0.0047	4700	0.0055~0.0079	3700	0.0055~0.0079	1050	0.0024~0.0043
8	3600	0.0063~0.0094	3600	0.0063~0.0094	2400	0.0063~0.0094	1400	0.0031~0.0063	3600	0.0063~0.0094	2800	0.0063~0.0094	800	0.0031~0.0055
10	2800	0.0071~0.0106	2800	0.0071~0.0106	1900	0.0071~0.0106	1100	0.0039~0.0071	2800	0.0071~0.0106	2200	0.0071~0.0106	600	0.0039~0.0063
12	2400	0.0079~0.0118	2400	0.0079~0.0118	1600	0.0079~0.0118	930	0.0047~0.0079	2400	0.0079~0.0118	1900	0.0079~0.0118	500	0.0047~0.0071
14	2100	0.0087~0.0138	2100	0.0087~0.0138	1400	0.0087~0.0138	800	0.0051~0.0087	2100	0.0087~0.0138	1600	0.0087~0.0138	450	0.0051~0.0079
16	1800	0.0098~0.0142	1800	0.0098~0.0142	1200	0.0098~0.0142	700	0.0055~0.0098	1800	0.0098~0.0142	1400	0.0098~0.0142	400	0.0055~0.0091
18	1600	0.0110~0.0150	1600	0.0110~0.0150	1100	0.0110~0.0150	620	0.0059~0.011	1600	0.0110~0.0150	1200	0.0110~0.0150	350	0.0059~0.0098
20	1400	0.0118~0.0157	1400	0.0118~0.0157	950	0.0118~0.0157	550	0.0063~0.0118	1400	0.0118~0.0157	1100	0.0118~0.0157	320	0.0063~0.011

1. When the tool is used for the first time, please do a test cutting with 90% of the cutting speed or 85% of the feed rate stated above. As cutting conditions become stable, gradually increase the cutting speed and feed rate.
2. The cutting conditions above are applicable for drilling with emulsion.
3. When clamping drill, please use a collet without any defect or dust, and keep the radial run-out of drill under 0.02mm.
4. These conditions above are applicable for cutting depth under 5D.



GD series twist drills(internal coolant)

3D 5D

workpiece material	Mild steel HB≤180		Carbon steel, alloy steel ~30HRC		Pre-hardened steel ~40HRC		Stainless steel		Cast iron		Nodular cast iron		Heat resistant alloy	
Cutting speed	265~500SFPM		265~500SFPM		165~265SFPM		165~265SFPM		265~500SFPM		200~395SFPM		50~85SFPM	
Diameter (mm)	Rotating speed (r/min)	Feed rate (in/rev)	Rotating speed (r/min)	Feed rate (in/rev)	Rotating speed (r/min)	Feed rate (in/rev)	Rotating speed (r/min)	Feed rate (in/rev)	Rotating speed (r/min)	Feed rate (in/rev)	Rotating speed (r/min)	Feed rate (in/rev)	Rotating speed (r/min)	Feed rate (in/rev)
3	12700	0.0035-0.0047	12700	0.0035-0.0047	7400	0.0035-0.0047	6300	0.0012-0.0028	12700	0.0035-0.0047	9500	0.0035-0.0047	2100	0.0012-0.0024
4	9600	0.0039-0.0059	9600	0.0039-0.0059	5600	0.0039-0.0059	4700	0.0016-0.0031	9600	0.0039-0.0059	7000	0.0039-0.0059	1600	0.0016-0.0028
5	7600	0.0047-0.0071	7600	0.0047-0.0071	4500	0.0047-0.0071	3800	0.002-0.0039	7600	0.0047-0.0071	5700	0.0047-0.0071	1250	0.002-0.0035
6	6400	0.0055-0.0079	6400	0.0055-0.0079	3700	0.0055-0.0079	3200	0.0024-0.0047	6400	0.0055-0.0079	4700	0.0055-0.0079	1050	0.0024-0.0043
8	4800	0.0063-0.0094	4800	0.0063-0.0094	2800	0.0063-0.0094	2400	0.0031-0.0063	4800	0.0063-0.0094	3600	0.0063-0.0094	800	0.0031-0.0055
10	3800	0.0071-0.0106	3800	0.0071-0.0106	2200	0.0071-0.0106	1900	0.0039-0.0071	3800	0.0071-0.0106	2800	0.0071-0.0106	600	0.0039-0.0063
12	3200	0.0079-0.0118	3200	0.0079-0.0118	1900	0.0079-0.0118	1600	0.0047-0.0079	3200	0.0079-0.0118	2400	0.0079-0.0118	500	0.0047-0.0071
14	2700	0.0087-0.0138	2700	0.0087-0.0138	1600	0.0087-0.0138	1350	0.0051-0.0087	2700	0.0087-0.0138	2100	0.0087-0.0138	450	0.0051-0.0079
16	2400	0.0098-0.0142	2400	0.0098-0.0142	1400	0.0098-0.0142	1200	0.0055-0.0098	2400	0.0098-0.0142	1800	0.0098-0.0142	400	0.0055-0.0091
18	2100	0.011-0.015	2100	0.011-0.015	1200	0.011-0.015	1050	0.0059-0.011	2100	0.011-0.015	1600	0.011-0.015	350	0.0059-0.0098
20	1900	0.0118-0.0157	1900	0.0118-0.0157	1100	0.0118-0.0157	950	0.0063-0.0118	1900	0.0118-0.0157	1400	0.0118-0.0157	320	0.0063-0.011

1. When the tool is used for the first time, please do a test cutting with 90% of the cutting speed or 85% of the feed rate stated above. As cutting conditions become stable, gradually increase the cutting speed and feed rate.
2. The cutting conditions above are applicable for drilling with emulsion.
3. When clamping drill, please use a collet without any defect or dust, and keep the radial run-out of drill under 0.02mm.
4. These conditions above are applicable for cutting depth under 5D.

GD series twist drills(internal coolant)

8D

workpiece material	Mild steel HB≤180		Carbon steel, alloy steel ~30HRC		Pre-hardened steel ~40HRC		Stainless steel		Cast iron		Nodular cast iron		Heat resistant alloy	
Cutting speed	265~500SFPM		265~500SFPM		165~265SFPM		135~200SFPM		265~500SFPM		200~395SFPM		50~85SFPM	
Diameter (mm)	Rotating speed (r/min)	Feed rate (in/rev)	Rotating speed (r/min)	Feed rate (in/rev)	Rotating speed (r/min)	Feed rate (in/rev)	Rotating speed (r/min)	Feed rate (in/rev)	Rotating speed (r/min)	Feed rate (in/rev)	Rotating speed (r/min)	Feed rate (in/rev)	Rotating speed (r/min)	Feed rate (in/rev)
3	12700	0.0024-0.0039	12700	0.0024-0.0039	7400	0.0024-0.0039	5300	0.0012-0.0028	12700	0.0024-0.0039	9500	0.0024-0.0039	2100	0.0012-0.0024
4	9600	0.0031-0.0047	9600	0.0031-0.0047	5600	0.0031-0.0047	4000	0.0016-0.0031	9600	0.0031-0.0047	7000	0.0031-0.0047	1600	0.0016-0.0028
5	7600	0.0039-0.0055	7600	0.0039-0.0055	4500	0.0039-0.0055	3200	0.002-0.0039	7600	0.0039-0.0055	5700	0.0039-0.0055	1250	0.002-0.0035
6	6400	0.0043-0.0063	6400	0.0043-0.0063	3700	0.0043-0.0063	2700	0.0024-0.0047	6400	0.0043-0.0063	4700	0.0043-0.0063	1050	0.0024-0.0043
8	4800	0.0051-0.0075	4800	0.0051-0.0075	2800	0.0051-0.0075	2000	0.0031-0.0063	4800	0.0051-0.0075	3600	0.0051-0.0075	800	0.0031-0.0055
10	3800	0.0055-0.0087	3800	0.0055-0.0087	2200	0.0055-0.0087	1600	0.0039-0.0071	3800	0.0055-0.0087	2800	0.0055-0.0087	600	0.0039-0.0063
12	3200	0.0063-0.0094	3200	0.0063-0.0094	1900	0.0063-0.0094	1300	0.0047-0.0079	3200	0.0063-0.0094	2400	0.0063-0.0094	500	0.0047-0.0071
14	2700	0.0071-0.011	2700	0.0071-0.011	1600	0.0071-0.011	1100	0.0051-0.0087	2700	0.0071-0.011	2100	0.0071-0.011	450	0.0051-0.0079
16	2400	0.0079-0.0114	2400	0.0079-0.0114	1400	0.0079-0.0114	1000	0.0055-0.0098	2400	0.0079-0.0114	1800	0.0079-0.0114	400	0.0055-0.0091
18	2100	0.0094-0.0126	2100	0.0094-0.0126	1200	0.0094-0.0126	880	0.0059-0.011	2100	0.0094-0.0126	1600	0.0094-0.0126	350	0.0059-0.0098

1. When the tool is used for the first time, please do a test cutting with 90% of the cutting speed or 85% of the feed rate stated above. As cutting conditions become stable, gradually increase the cutting speed and feed rate.
2. The cutting conditions above are applicable for drilling with emulsion.
3. When clamping drill, please use a collet without any defect or dust, and keep the radial run-out of drill under 0.02mm.
4. These conditions above are applicable for cutting depth under 8D.

SL series deep twist drills(external coolant)

12D

workpiece material	Mild steel HB≤180		Carbon steel, alloy steel ~30HRC		Pre-hardened steel ~40HRC		Stainless steel		Cast iron		Nodular cast iron		Aluminum alloy		Heat resistant alloy	
Cutting speed	200~395SFPM		200~395SFPM		165~265SFPM		135~200SFPM		265~500SFPM		200~395SFPM		330~590SFPM		35~70SFPM	
Diameter (mm)	Rotating speed (r/min)	Feed rate (in/rev)	Rotating speed (r/min)	Feed rate (in/rev)	Rotating speed (r/min)	Feed rate (in/rev)	Rotating speed (r/min)	Feed rate (in/rev)	Rotating speed (r/min)	Feed rate (in/rev)	Rotating speed (r/min)	Feed rate (in/rev)	Rotating speed (r/min)	Feed rate (in/rev)	Rotating speed (r/min)	Feed rate (in/rev)
3	10600	0.0024-0.0039	10600	0.0024-0.0039	7400	0.0024-0.0039	5300	0.0012-0.0028	12700	0.0024-0.0039	9500	0.0024-0.0039	15000	0.0035-0.0047	2100	0.0012-0.0024
4	8000	0.0031-0.0047	8000	0.0031-0.0047	5600	0.0031-0.0047	4000	0.0016-0.0031	96000	0.0031-0.0047	7000	0.0031-0.0047	11000	0.0039-0.0059	1600	0.0016-0.0028
5	6400	0.0039-0.0055	6400	0.0039-0.0055	4500	0.0039-0.0055	3200	0.002-0.0039	7600	0.0039-0.0055	5700	0.0039-0.0055	9000	0.0039-0.0059	1250	0.002-0.0035
6	5300	0.0043-0.0063	5300	0.0043-0.0063	3700	0.0043-0.0063	2700	0.0024-0.0047	6400	0.0043-0.0063	4700	0.0043-0.0063	7400	0.0043-0.0063	1050	0.0024-0.0043
8	4000	0.0051-0.0075	4000	0.0051-0.0075	2800	0.0051-0.0075	2000	0.0031-0.0063	4800	0.0051-0.0075	3600	0.0051-0.0075	5600	0.0051-0.0075	800	0.0031-0.0055
10	3200	0.0055-0.0087	3200	0.0055-0.0087	2200	0.0055-0.0087	1600	0.0039-0.0071	3800	0.0055-0.0087	2800	0.0055-0.0087	4500	0.0055-0.0087	600	0.0039-0.0063
12	2700	0.0063-0.0094	2700	0.0063-0.0094	1900	0.0063-0.0094	1300	0.0047-0.0079	3200	0.0063-0.0094	2400	0.0063-0.0094	3700	0.0063-0.0094	500	0.0047-0.0071
14	2300	0.0071-0.011	2300	0.0071-0.011	1600	0.0071-0.011	1100	0.0051-0.0087	2700	0.0071-0.011	2100	0.0071-0.011	3200	0.0071-0.011	450	0.0051-0.0079
16	2100	0.0079-0.0118	2100	0.0079-0.0118	1400	0.0079-0.0118	1050	0.0055-0.0098	2100	0.0079-0.0118	1800	0.0079-0.0118	2800	0.0098-0.0142	400	0.0055-0.0091
18	1800	0.0087-0.0126	1800	0.0087-0.0126	1200	0.0087-0.0126	950	0.0059-0.011	1800	0.0087-0.0126	1600	0.0087-0.0126	2500	0.011-0.015	350	0.0059-0.0098
20	1600	0.0098-0.0138	1600	0.0098-0.0138	1100	0.0098-0.0138	800	0.0063-0.0118	1600	0.0098-0.0138	1400	0.0098-0.0138	2300	0.0118-0.0157	320	0.0063-0.011

1. When the tool is used for the first time, please do a test cutting with 90% of the cutting speed or 85% of the feed rate stated above. As cutting conditions become stable, gradually increase the cutting speed and feed rate.
2. The cutting conditions above are applicable for drilling with emulsion.
3. When clamping drill, please use a collet without any defect or dust, and keep the radial run-out of drill under 0.02mm.

SL series deep twist drills(internal coolant)

20D 30D

workpiece material	Mild steel HB≤180		Carbon steel, alloy steel ~30HRC		Pre-hardened steel ~40HRC		Stainless steel		Cast iron		Nodular cast iron		Aluminum alloy		Heat resistant alloy	
Cutting speed	200~395SFPM		200~395SFPM		165~265SFPM		135~200SFPM		265~500SFPM		200~395SFPM		330~590SFPM		35~75SFPM	
Diameter (mm)	Rotating speed (r/min)	Feed rate (in/rev)	Rotating speed (r/min)	Feed rate (in/rev)	Rotating speed (r/min)	Feed rate (in/rev)	Rotating speed (r/min)	Feed rate (in/rev)	Rotating speed (r/min)	Feed rate (in/rev)	Rotating speed (r/min)	Feed rate (in/rev)	Rotating speed (r/min)	Feed rate (in/rev)	Rotating speed (r/min)	Feed rate (in/rev)
3	10600	0.0024-0.0039	10600	0.0024-0.0039	7400	0.0024-0.0039	5300	0.0012-0.0028	12700	0.0024-0.0039	9500	0.0024-0.0039	15000	0.0035-0.0047	2100	0.0012-0.0024
4	8000	0.0031-0.0047	8000	0.0031-0.0047	5600	0.0031-0.0047	4000	0.0016-0.0031	96000	0.0031-0.0047	7000	0.0031-0.0047	11000	0.0039-0.0059	1600	0.0016-0.0028
5	6400	0.0039-0.0055	6400	0.0039-0.0055	4500	0.0039-0.0055	3200	0.002-0.0039	7600	0.0039-0.0055	5700	0.0039-0.0055	9000	0.0039-0.0059	1250	0.002-0.0035
6	5300	0.0043-0.0063	5300	0.0043-0.0063	3700	0.0043-0.0063	2700	0.0024-0.0047	6400	0.0043-0.0063	4700	0.0043-0.0063	7400	0.0043-0.0063	1050	0.0024-0.0043
8	4000	0.0051-0.0075	4000	0.0051-0.0075	2800	0.0051-0.0075	2000	0.0031-0.0063	4800	0.0051-0.0075	3600	0.0051-0.0075	5600	0.0051-0.0075	800	0.0031-0.0055
10	3200	0.0055-0.0087	3200	0.0055-0.0087	2200	0.0055-0.0087	1600	0.0039-0.0071	3800	0.0055-0.0087	2800	0.0055-0.0087	4500	0.0055-0.0087	600	0.0039-0.0063
12	2700	0.0063-0.0094	2700	0.0063-0.0094	1900	0.0063-0.0094	1300	0.0047-0.0079	3200	0.0063-0.0094	2400	0.0063-0.0094	3700	0.0063-0.0094	500	0.0047-0.0071
14	2300	0.0071-0.011	2300	0.0071-0.011	1600	0.0071-0.011	1100	0.0051-0.0087	2700	0.0071-0.011	2100	0.0071-0.011	3200	0.0071-0.011	450	0.0051-0.0079

1. When the tool is used for the first time, please do a test cutting with 90% of the cutting speed or 85% of the feed rate stated above. As cutting conditions become stable, gradually increase the cutting speed and feed rate.
2. The cutting conditions above are applicable for drilling with emulsion.
3. When clamping drill, please use a collet without any defect or dust, and keep the radial run-out of drill under 0.02mm.



ZTD New shallow
drill series

Indexable Insert Short Hole Drills

Tool type	
Code	Description
ZTD	Indexable Insert Short Hole Drill Coolant-fed

The ratio of length and diameter
02, 03, 04, 05

Tool diameter(inch)	
Range	
	0.500-2.000

Mounting Type	
Code	Description
XP	Weldon shank

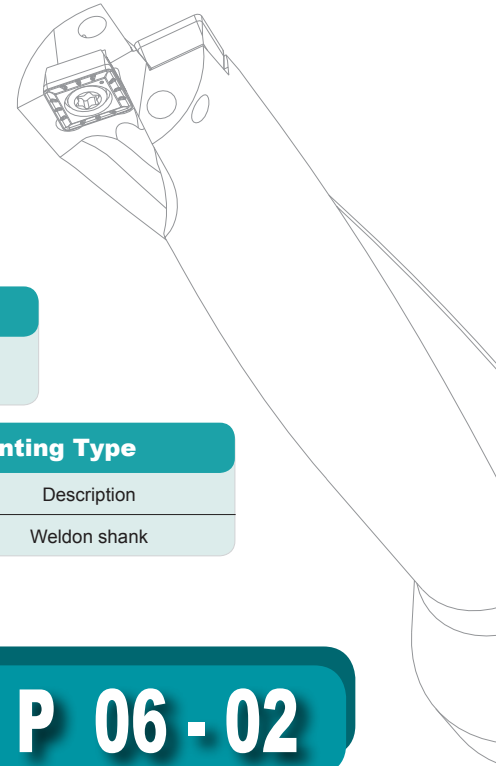

ZTD 03 - 0.672 - XP 1.00 - S P 06 - 02

Mounting Size(inch)
1.00, 1.25, 1.50

Insert shape	
S	

Insert clearance angle	
C	7°
P	11°

Cutting edge length(inch)	
Code	Edge length
	S
05	0.197
06	0.236
07	0.313
09	0.386
11	0.453
14	0.563

Number of tooth
02

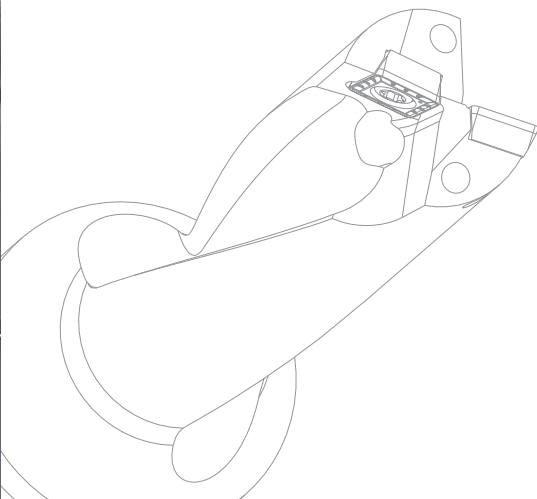

ZTD03/04/05 new short hole drill series

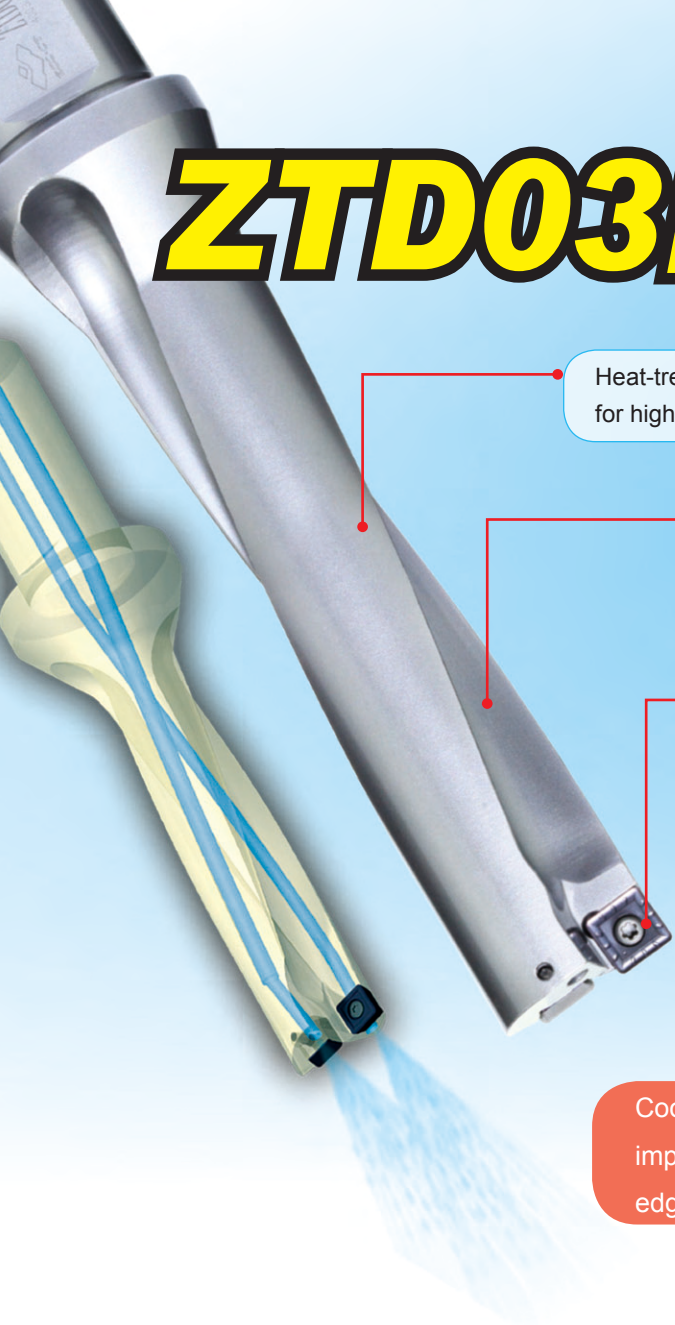

Heat-treated drill body has high torque capability for higher feed rates.

Large flute gullets allow chips to evacuate freely.

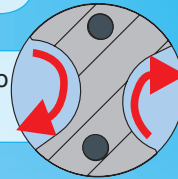

Insert positioning attitude reduces vibrations, allows for more precise hole size, and improves surface finish quality.

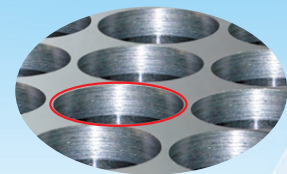
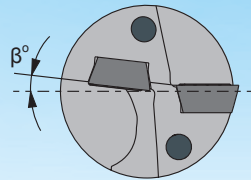

Coolant-fed through helical flutes permit improved cooling and lubricating of the cutting edges, while allowing greater depth of cut.

Case

Tool applied	ZTD04-1.031"-XP1.00"-SP07-02 SPGT07T308-PM /YBG205(Peripheral edge) SPGT07T308-PM /YBG212(Inner edge)	Tool life comparison	<p>Number of hole drilled (pc)</p> <p>ZTD04 Similar product of company A</p>
Workpiece material	1050 steel (HRC 25)		
Cooling system	Double helical internal cooling		
Cutting parameters	$V_c=426$ sfpm, $f=8.25$ in/min, $a_p=3.5$ in		
Machining situation		Chips	<p>ZTD04-1.031"-XP1.00"-SP07-2 Similar product of company a</p>

- Optimized cutting edge design ensures more stable cutting and better chip breaking.
- Meeting the requirements of central edge and peripheral edge with economy and efficiency.
- Perfect combination of grade and chipbreaker solves all your difficulties in machining.

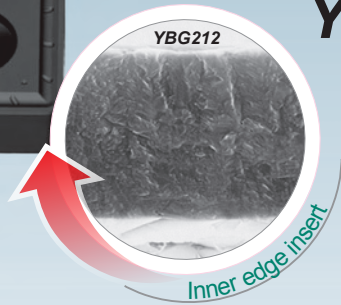
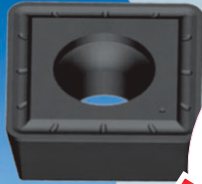
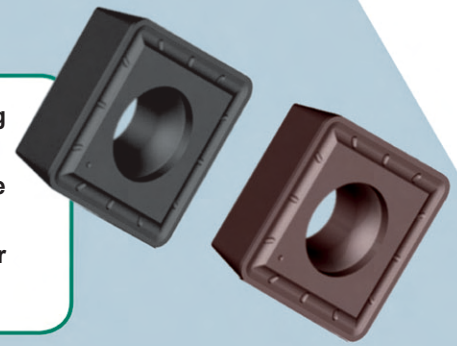

YBG212

- Special coating technology makes insert surface smooth, reducing friction and ensuring unobstructed chip flow.
- Unique nano coating, stronger combination of substrate and highly wear-resistant TiAlN coating, higher toughness and hardness.
- Good thermal stability and chemical stability of coating provide more effective protection for the cutting edge.
- Ultra-fine solid carbide substrate with high toughness ensures high strength of cutting edge.

YBG205

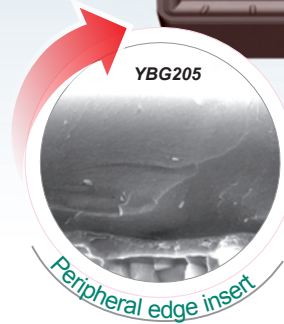

- Ultra-fine TiAlN base nano coating added with wear-resistant and heat-resistant elements greatly improves over-all properties.
- Special coating technology ensures stronger combination of substrate and coating.
- Thin PVD coating, sharp cutting edge.
- Fine grain WC base solid carbide with high hardness and high toughness.
- Special surface treatment after coating improves surface finish while eliminating harmful stress.

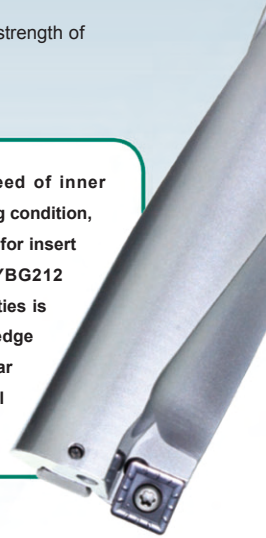

Because of the low speed of inner edge and the poor working condition, there is high requirement for insert toughness. Therefore, YBG212 with good over-all properties is recommended for inner edge and YBG205 with high wear resistance for peripheral edge.

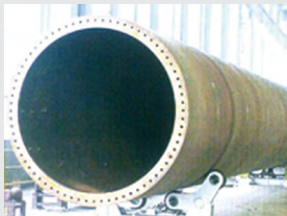

Case

Workpiece		Cooling system	Double helical internal cooling	
		Insert applied	SPGT07T308-PM/YBG205	Similar product of company A
Workpiece material	Alloy Steel(HRC25)	Comparison of insert wear (after 15 minutes of machining)		
Cutting parameters	$V_c=495\text{SFPM}$, $f_r=.005\text{in/r}$, $a_p= 3.1\text{ in}$			

Indexable Insert Short Hole Drills

Indexable insert short hole drills

ZTD03

3D

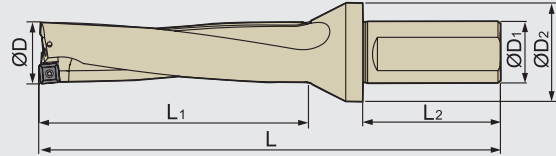

ØD		Type						Applicable inserts	Screw	Wrench
inch	mm		ØD ₁	ØD ₂	L ₂	L ₁	L			
0.500	12.70	ZTD03-0.500"-XP0.75"-SP05-02	0.75	0.98	1.97	1.70	4.33	SPGT050204-PM	I60M2×4.3	WT06IP
0.531	13.49	ZTD03-0.531"-XP0.75"-SP05-02	0.75	0.98	1.97	1.79	4.43	SPGT050204-PM	I60M2×4.3	WT06IP
0.563	14.30	ZTD03-0.563"-XP0.75"-SP05-02	0.75	0.98	1.97	1.89	4.52	SPGT050204-PM	I60M2×4.3	WT06IP
0.594	15.09	ZTD03-0.594"-XP0.75"-SP05-02	0.75	0.98	1.97	1.98	4.62	SPGT050204-PM	I60M2×4.3	WT06IP
0.626	15.90	ZTD03-0.626"-XP0.75"-SP05-02	0.75	0.98	1.97	2.07	4.71	SPGT050204-PM	I60M2×4.3	WT06IP
0.657	16.69	ZTD03-0.657"-XP1.00"-SP06-02	1.00	1.26	2.20	2.17	5.24	SPGT060204-PM	I60M2.2×5.5	WT07IP
0.688	17.48	ZTD03-0.688"-XP1.00"-SP06-02	1.00	1.26	2.20	2.26	5.33	SPGT060204-PM	I60M2.2×5.5	WT07IP
0.719	18.26	ZTD03-0.719"-XP1.00"-SP06-02	1.00	1.26	2.20	2.35	5.42	SPGT060204-PM	I60M2.2×5.5	WT07IP
0.750	19.05	ZTD03-0.750"-XP1.00"-SP06-02	1.00	1.26	2.20	2.45	5.52	SPGT060204-PM	I60M2.2×5.5	WT07IP
0.781	19.84	ZTD03-0.781"-XP1.00"-SP06-02	1.00	1.26	2.20	2.54	5.61	SPGT060204-PM	I60M2.2×5.5	WT07IP
0.813	20.65	ZTD03-0.813"-XP1.00"-SP06-02	1.00	1.26	2.20	2.64	5.71	SPGT060204-PM	I60M2.2×5.5	WT07IP
0.843	21.41	ZTD03-0.843"-XP1.00"-SP06-02	1.00	1.26	2.20	2.73	5.80	SPGT060204-PM	I60M2.2×5.5	WT07IP
0.875	22.23	ZTD03-0.875"-XP1.00"-SP07-02	1.00	1.26	2.20	2.82	5.89	SPGT07T308-PM	I60M2.5×6.5	WT07IP
0.906	23.01	ZTD03-0.906"-XP1.00"-SP07-02	1.00	1.26	2.20	2.91	5.99	SPGT07T308-PM	I60M2.5×6.5	WT07IP
0.938	23.83	ZTD03-0.938"-XP1.00"-SP07-02	1.00	1.26	2.20	3.01	6.08	SPGT07T308-PM	I60M2.5×6.5	WT07IP
0.969	24.61	ZTD03-0.969"-XP1.00"-SP07-02	1.00	1.26	2.20	3.10	6.17	SPGT07T308-PM	I60M2.5×6.5	WT07IP
1.000	25.40	ZTD03-1.000"-XP1.00"-SP07-02	1.00	1.26	2.20	3.20	6.27	SPGT07T308-PM	I60M2.5×6.5	WT07IP
1.031	26.19	ZTD03-1.031"-XP1.00"-SP07-02	1.00	1.26	2.20	3.29	6.36	SPGT07T308-PM	I60M2.5×6.5	WT07IP
1.063	27.00	ZTD03-1.063"-XP1.00"-SP07-02	1.00	1.46	2.20	3.39	6.46	SPGT07T308-PM	I60M2.5×6.5	WT07IP
1.094	27.79	ZTD03-1.094"-XP1.25"-SP09-02	1.25	1.46	2.36	3.48	6.83	SPGT090408-PM	I60M3.5×8	WT15IP
1.125	28.58	ZTD03-1.125"-XP1.25"-SP09-02	1.25	1.46	2.36	3.57	6.92	SPGT090408-PM	I60M3.5×8	WT15IP
1.156	29.36	ZTD03-1.156"-XP1.25"-SP09-02	1.25	1.46	2.36	3.66	7.01	SPGT090408-PM	I60M3.5×8	WT15IP
1.187	30.15	ZTD03-1.187"-XP1.25"-SP09-02	1.25	1.46	2.36	3.76	7.10	SPGT090408-PM	I60M3.5×8	WT15IP
1.219	30.96	ZTD03-1.219"-XP1.25"-SP09-02	1.25	1.46	2.36	3.85	7.20	SPGT090408-PM	I60M3.5×8	WT15IP
1.250	31.75	ZTD03-1.250"-XP1.25"-SP09-02	1.25	1.46	2.36	3.95	7.29	SPGT090408-PM	I60M3.5×8	WT15IP
1.281	32.54	ZTD03-1.281"-XP1.25"-SP09-02	1.25	1.46	2.36	4.04	7.39	SPGT090408-PM	I60M3.5×8	WT15IP
1.312	33.32	ZTD03-1.312"-XP1.25"-SP09-02	1.25	1.46	2.36	4.13	7.48	SPGT090408-PM	I60M3.5×8	WT15IP

F

ZTD03

3D

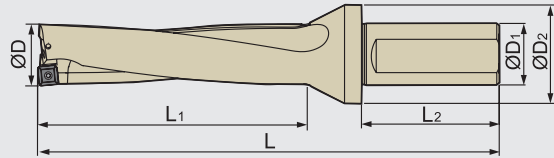

ØD		Type						Applicable inserts	Screw	Wrench
inch	mm		ØD ₁	ØD ₂	L ₂	L ₁	L			
1.343	34.11	ZTD03-1.343"-XP1.50"-SP11-02	1.50	1.85	2.76	4.23	8.16	SPGT110408-PM	I60M4×10	WT15IP
1.375	34.93	ZTD03-1.375"-XP1.50"-SP11-02	1.50	1.85	2.76	4.32	8.26	SPGT110408-PM	I60M4×10	WT15IP
1.406	35.71	ZTD03-1.406"-XP1.50"-SP11-02	1.50	1.85	2.76	4.41	8.35	SPGT110408-PM	I60M4×10	WT15IP
1.437	36.50	ZTD03-1.437"-XP1.50"-SP11-02	1.50	1.85	2.76	4.51	8.44	SPGT110408-PM	I60M4×10	WT15IP
1.468	37.29	ZTD03-1.468"-XP1.50"-SP11-02	1.50	1.85	2.76	4.60	8.54	SPGT110408-PM	I60M4×10	WT15IP
1.500	38.10	ZTD03-1.500"-XP1.50"-SP11-02	1.50	1.85	2.76	4.70	8.63	SPGT110408-PM	I60M4×10	WT15IP
1.531	38.89	ZTD03-1.531"-XP1.50"-SP11-02	1.50	1.85	2.76	4.79	8.73	SPGT110408-PM	I60M4×10	WT15IP
1.562	39.67	ZTD03-1.562"-XP1.50"-SP11-02	1.50	1.85	2.76	4.88	8.82	SPGT110408-PM	I60M4×10	WT15IP
1.594	40.49	ZTD03-1.594"-XP1.50"-SP11-02	1.50	1.85	2.76	4.98	8.92	SPGT110408-PM	I60M4×10	WT15IP
1.625	41.28	ZTD03-1.625"-XP1.50"-SP11-02	1.50	1.85	2.76	5.07	9.01	SPGT110408-PM	I60M4×10	WT15IP
1.687	42.85	ZTD03-1.687"-XP1.50"-SP14-02	1.50	2.24	2.76	5.26	9.59	SPGT140512-PM	I60M5×13	WT20IP
1.719	43.66	ZTD03-1.719"-XP1.50"-SP14-02	1.50	2.24	2.76	5.35	9.68	SPGT140512-PM	I60M5×13	WT20IP
1.750	44.45	ZTD03-1.750"-XP1.50"-SP14-02	1.50	2.24	2.76	5.45	9.78	SPGT140512-PM	I60M5×13	WT20IP
1.781	45.24	ZTD03-1.781"-XP1.50"-SP14-02	1.50	2.24	2.76	5.54	9.87	SPGT140512-PM	I60M5×13	WT20IP
1.813	46.05	ZTD03-1.813"-XP1.50"-SP14-02	1.50	2.24	2.76	5.64	9.97	SPGT140512-PM	I60M5×13	WT20IP
1.875	47.23	ZTD03-1.875"-XP1.50"-SP14-02	1.50	2.24	2.76	5.82	10.15	SPGT140512-PM	I60M5×13	WT20IP
1.937	49.20	ZTD03-1.937"-XP1.50"-SP14-02	1.50	2.24	2.76	6.01	10.34	SPGT140512-PM	I60M5×13	WT20IP
1.969	50.01	ZTD03-1.969"-XP1.50"-SP14-02	1.50	2.24	2.76	6.10	10.43	SPGT140512-PM	I60M5×13	WT20IP
2.000	50.80	ZTD03-2.000"-XP1.50"-SP14-02	1.50	2.24	2.76	6.20	10.53	SPGT140512-PM	I60M5×13	WT20IP

Indexable Insert Short Hole Drills

Indexable insert short hole drills

ZTD04

4D

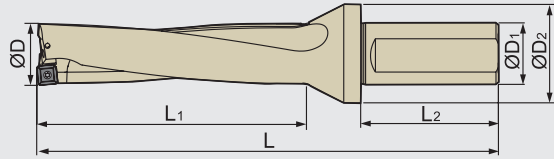

ØD		Type						Applicable inserts	Screw	Wrench
inch	mm		ØD ₁	ØD ₂	L ₂	L ₁	L			
0.500	12.70	ZTD04-0.500"-XP0.75"-SP05-02	0.75	0.98	1.97	2.20	4.83	SPGT050204-PM	I60M2×4.3	WT06IP
0.531	13.49	ZTD04-0.531"-XP0.75"-SP05-02	0.75	0.98	1.97	2.32	4.96	SPGT050204-PM	I60M2×4.3	WT06IP
0.563	14.30	ZTD04-0.563"-XP0.75"-SP05-02	0.75	0.98	1.97	2.45	5.09	SPGT050204-PM	I60M2×4.3	WT06IP
0.594	15.09	ZTD04-0.594"-XP0.75"-SP05-02	0.75	0.98	1.97	2.57	5.21	SPGT050204-PM	I60M2×4.3	WT06IP
0.626	15.90	ZTD04-0.626"-XP0.75"-SP05-02	0.75	0.98	1.97	2.70	5.34	SPGT050204-PM	I60M2×4.3	WT06IP
0.657	16.69	ZTD04-0.657"-XP1.00"-SP06-02	1.00	1.26	2.20	2.82	5.90	SPGT060204-PM	I60M2.2×5.5	WT07IP
0.688	17.48	ZTD04-0.688"-XP1.00"-SP06-02	1.00	1.26	2.20	2.95	6.02	SPGT060204-PM	I60M2.2×5.5	WT07IP
0.719	18.26	ZTD04-0.719"-XP1.00"-SP06-02	1.00	1.26	2.20	3.07	6.14	SPGT060204-PM	I60M2.2×5.5	WT07IP
0.750	19.05	ZTD04-0.750"-XP1.00"-SP06-02	1.00	1.26	2.20	3.20	6.27	SPGT060204-PM	I60M2.2×5.5	WT07IP
0.781	19.84	ZTD04-0.781"-XP1.00"-SP06-02	1.00	1.26	2.20	3.32	6.39	SPGT060204-PM	I60M2.2×5.5	WT07IP
0.813	20.65	ZTD04-0.813"-XP1.00"-SP06-02	1.00	1.26	2.20	3.45	6.52	SPGT060204-PM	I60M2.2×5.5	WT07IP
0.843	21.41	ZTD04-0.843"-XP1.00"-SP06-02	1.00	1.26	2.20	3.57	6.64	SPGT060204-PM	I60M2.2×5.5	WT07IP
0.875	22.23	ZTD04-0.875"-XP1.00"-SP07-02	1.00	1.26	2.20	3.70	6.77	SPGT07T308-PM	I60M2.5×6.5	WT07IP
0.906	23.01	ZTD04-0.906"-XP1.00"-SP07-02	1.00	1.26	2.20	3.82	6.89	SPGT07T308-PM	I60M2.5×6.5	WT07IP
0.938	23.83	ZTD04-0.938"-XP1.00"-SP07-02	1.00	1.26	2.20	3.95	7.02	SPGT07T308-PM	I60M2.5×6.5	WT07IP
0.969	24.61	ZTD04-0.969"-XP1.00"-SP07-02	1.00	1.26	2.20	4.07	7.14	SPGT07T308-PM	I60M2.5×6.5	WT07IP
1.000	25.40	ZTD04-1.000"-XP1.00"-SP07-02	1.00	1.26	2.20	4.20	7.27	SPGT07T308-PM	I60M2.5×6.5	WT07IP
1.031	26.19	ZTD04-1.031"-XP1.00"-SP07-02	1.00	1.26	2.20	4.32	7.39	SPGT07T308-PM	I60M2.5×6.5	WT07IP
1.063	27.00	ZTD04-1.063"-XP1.00"-SP07-02	1.00	1.46	2.20	4.45	7.52	SPGT07T308-PM	I60M2.5×6.5	WT07IP
1.094	27.79	ZTD04-1.094"-XP1.25"-SP09-02	1.25	1.46	2.36	4.57	7.92	SPGT090408-PM	I60M3.5×8	WT15IP
1.125	28.58	ZTD04-1.125"-XP1.25"-SP09-02	1.25	1.46	2.36	4.70	8.04	SPGT090408-PM	I60M3.5×8	WT15IP
1.156	29.36	ZTD04-1.156"-XP1.25"-SP09-02	1.25	1.46	2.36	4.82	8.17	SPGT090408-PM	I60M3.5×8	WT15IP
1.187	30.15	ZTD04-1.187"-XP1.25"-SP09-02	1.25	1.46	2.36	4.94	8.29	SPGT090408-PM	I60M3.5×8	WT15IP
1.219	30.96	ZTD04-1.219"-XP1.25"-SP09-02	1.25	1.46	2.36	5.07	8.42	SPGT090408-PM	I60M3.5×8	WT15IP
1.250	31.75	ZTD04-1.250"-XP1.25"-SP09-02	1.25	1.46	2.36	5.20	8.54	SPGT090408-PM	I60M3.5×8	WT15IP
1.281	32.54	ZTD04-1.281"-XP1.25"-SP09-02	1.25	1.46	2.36	5.32	8.67	SPGT090408-PM	I60M3.5×8	WT15IP
1.312	33.32	ZTD04-1.312"-XP1.25"-SP09-02	1.25	1.46	2.36	5.44	8.79	SPGT090408-PM	I60M3.5×8	WT15IP
1.343	34.11	ZTD04-1.343"-XP1.50"-SP11-02	1.50	1.85	2.76	5.57	9.51	SPGT110408-PM	I60M4×10	WT15IP
1.375	34.93	ZTD04-1.375"-XP1.50"-SP11-02	1.50	1.85	2.76	5.70	9.63	SPGT110408-PM	I60M4×10	WT15IP
1.406	35.71	ZTD04-1.406"-XP1.50"-SP11-02	1.50	1.85	2.76	5.82	9.76	SPGT110408-PM	I60M4×10	WT15IP
1.437	36.50	ZTD04-1.437"-XP1.50"-SP11-02	1.50	1.85	2.76	5.94	9.88	SPGT110408-PM	I60M4×10	WT15IP
1.468	37.29	ZTD04-1.468"-XP1.50"-SP11-02	1.50	1.85	2.76	6.07	10.01	SPGT110408-PM	I60M4×10	WT15IP

F

ZTD04

4D

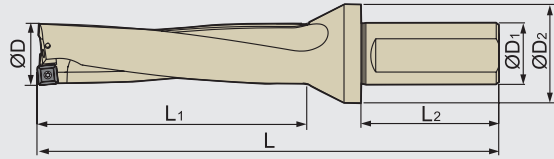

ØD		Type						Applicable inserts	Screw	Wrench
inch	mm		ØD ₁	ØD ₂	L ₂	L ₁	L			
1.500	38.10	ZTD04-1.500"-XP1.50"-SP11-02	1.50	1.85	2.76	6.20	10.13	SPGT110408-PM	I60M4×10	WT15IP
1.531	38.89	ZTD04-1.531"-XP1.50"-SP11-02	1.50	1.85	2.76	6.32	10.26	SPGT110408-PM	I60M4×10	WT15IP
1.562	39.67	ZTD04-1.562"-XP1.50"-SP11-02	1.50	1.85	2.76	6.44	10.38	SPGT110408-PM	I60M4×10	WT15IP
1.594	40.49	ZTD04-1.594"-XP1.50"-SP11-02	1.50	1.85	2.76	6.57	10.51	SPGT110408-PM	I60M4×10	WT15IP
1.625	41.28	ZTD04-1.625"-XP1.50"-SP11-02	1.50	1.85	2.76	6.70	10.63	SPGT110408-PM	I60M4×10	WT15IP
1.687	42.85	ZTD04-1.687"-XP1.50"-SP14-02	1.50	2.24	2.76	6.94	11.28	SPGT140512-PM	I60M5×13	WT20IP
1.719	43.66	ZTD04-1.719"-XP1.50"-SP14-02	1.50	2.24	2.76	7.07	11.40	SPGT140512-PM	I60M5×13	WT20IP
1.750	44.45	ZTD04-1.750"-XP1.50"-SP14-02	1.50	2.24	2.76	7.20	11.53	SPGT140512-PM	I60M5×13	WT20IP
1.781	45.24	ZTD04-1.781"-XP1.50"-SP14-02	1.50	2.24	2.76	7.32	11.65	SPGT140512-PM	I60M5×13	WT20IP
1.813	46.05	ZTD04-1.813"-XP1.50"-SP14-02	1.50	2.24	2.76	7.45	11.78	SPGT140512-PM	I60M5×13	WT20IP
1.875	47.23	ZTD04-1.875"-XP1.50"-SP14-02	1.50	2.24	2.76	7.70	12.03	SPGT140512-PM	I60M5×13	WT20IP
1.937	49.20	ZTD04-1.937"-XP1.50"-SP14-02	1.50	2.24	2.76	7.94	12.28	SPGT140512-PM	I60M5×13	WT20IP
1.969	50.01	ZTD04-1.969"-XP1.50"-SP14-02	1.50	2.24	2.76	8.07	12.40	SPGT140512-PM	I60M5×13	WT20IP
2.000	50.80	ZTD04-2.000"-XP1.50"-SP14-02	1.50	2.24	2.76	8.20	12.53	SPGT140512-PM	I60M5×13	WT20IP

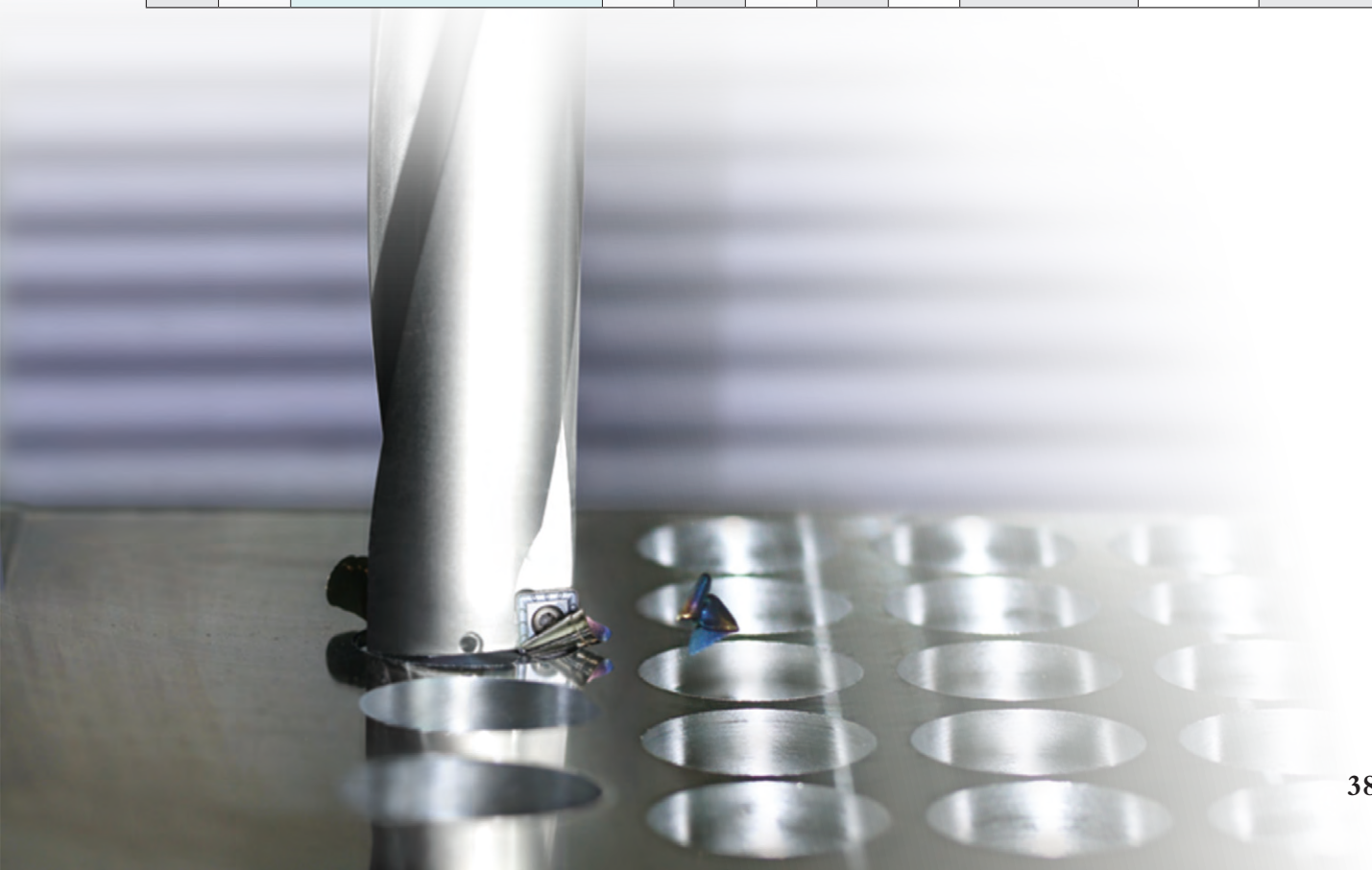

Indexable Insert Short Hole Drills

Indexable insert short hole drills

ZTD05

5D

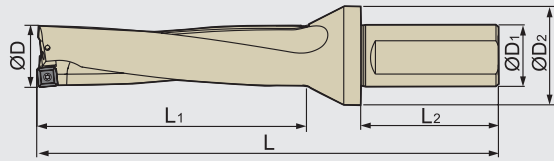

ØD		Type						Applicable inserts	crew	Wrench
inch	mm		ØD ₁	ØD ₂	L ₂	L ₁	L			
0.500	12.70	ZTD05-0.500"-XP0.75"-SP05-02	0.75	0.98	1.97	2.70	5.33	SPGT050204-PM	I60M2×4.3	WT06IP
0.531	13.49	ZTD05-0.531"-XP0.75"-SP05-02	0.75	0.98	1.97	2.85	5.49	SPGT050204-PM	I60M2×4.3	WT06IP
0.563	14.30	ZTD05-0.563"-XP0.75"-SP05-02	0.75	0.98	1.97	3.01	5.65	SPGT050204-PM	I60M2×4.3	WT06IP
0.594	15.09	ZTD05-0.594"-XP0.75"-SP05-02	0.75	0.98	1.97	3.17	5.80	SPGT050204-PM	I60M2×4.3	WT06IP
0.626	15.90	ZTD05-0.626"-XP0.75"-SP05-02	0.75	0.98	1.97	3.33	5.96	SPGT050204-PM	I60M2×4.3	WT06IP
0.657	16.69	ZTD05-0.657"-XP1.00"-SP06-02	1.00	1.26	2.20	3.48	6.55	SPGT060204-PM	I60M2.2×5.5	WT07IP
0.688	17.48	ZTD05-0.688"-XP1.00"-SP06-02	1.00	1.26	2.20	3.64	6.71	SPGT060204-PM	I60M2.2×5.5	WT07IP
0.719	18.26	ZTD05-0.719"-XP1.00"-SP06-02	1.00	1.26	2.20	3.79	6.86	SPGT060204-PM	I60M2.2×5.5	WT07IP
0.750	19.05	ZTD05-0.750"-XP1.00"-SP06-02	1.00	1.26	2.20	3.95	7.02	SPGT060204-PM	I60M2.2×5.5	WT07IP
0.781	19.84	ZTD05-0.781"-XP1.00"-SP06-02	1.00	1.26	2.20	4.10	7.17	SPGT060204-PM	I60M2.2×5.5	WT07IP
0.813	20.65	ZTD05-0.813"-XP1.00"-SP06-02	1.00	1.26	2.20	4.26	7.33	SPGT060204-PM	I60M2.2×5.5	WT07IP
0.843	21.41	ZTD05-0.843"-XP1.00"-SP06-02	1.00	1.26	2.20	4.41	7.48	SPGT060204-PM	I60M2.2×5.5	WT07IP
0.875	22.23	ZTD05-0.875"-XP1.00"-SP07-02	1.00	1.26	2.20	4.57	7.64	SPGT07T308-PM	I60M2.5×6.5	WT07IP
0.906	23.01	ZTD05-0.906"-XP1.00"-SP07-02	1.00	1.26	2.20	4.73	7.80	SPGT07T308-PM	I60M2.5×6.5	WT07IP
0.938	23.83	ZTD05-0.938"-XP1.00"-SP07-02	1.00	1.26	2.20	4.89	7.96	SPGT07T308-PM	I60M2.5×6.5	WT07IP
0.969	24.61	ZTD05-0.969"-XP1.00"-SP07-02	1.00	1.26	2.20	5.04	8.11	SPGT07T308-PM	I60M2.5×6.5	WT07IP
1.000	25.40	ZTD05-1.000"-XP1.00"-SP07-02	1.00	1.26	2.20	5.20	8.27	SPGT07T308-PM	I60M2.5×6.5	WT07IP
1.031	26.19	ZTD05-1.031"-XP1.00"-SP07-02	1.00	1.26	2.20	5.35	8.42	SPGT07T308-PM	I60M2.5×6.5	WT07IP
1.063	27.00	ZTD05-1.063"-XP1.00"-SP07-02	1.00	1.26	2.20	5.51	8.58	SPGT07T308-PM	I60M2.5×6.5	WT07IP
1.094	27.79	ZTD05-1.094"-XP1.25"-SP09-02	1.25	1.46	2.36	5.67	9.01	SPGT090408-PM	I60M3.5×8	WT15IP
1.125	28.58	ZTD05-1.125"-XP1.25"-SP09-02	1.25	1.46	2.36	5.82	9.17	SPGT090408-PM	I60M3.5×8	WT15IP
1.156	29.36	ZTD05-1.156"-XP1.25"-SP09-02	1.25	1.46	2.36	5.98	9.32	SPGT090408-PM	I60M3.5×8	WT15IP
1.187	30.15	ZTD05-1.187"-XP1.25"-SP09-02	1.25	1.46	2.36	6.13	9.48	SPGT090408-PM	I60M3.5×8	WT15IP
1.219	30.96	ZTD05-1.219"-XP1.25"-SP09-02	1.25	1.46	2.36	6.29	9.64	SPGT090408-PM	I60M3.5×8	WT15IP
1.250	31.75	ZTD05-1.250"-XP1.25"-SP09-02	1.25	1.46	2.36	6.45	9.79	SPGT090408-PM	I60M3.5×8	WT15IP
1.281	32.54	ZTD05-1.281"-XP1.25"-SP09-02	1.25	1.46	2.36	6.60	9.95	SPGT090408-PM	I60M3.5×8	WT15IP
1.312	33.32	ZTD05-1.312"-XP1.25"-SP09-02	1.25	1.46	2.36	6.76	10.10	SPGT090408-PM	I60M3.5×8	WT15IP
1.343	34.11	ZTD05-1.343"-XP1.50"-SP11-02	1.50	1.85	2.76	6.91	10.85	SPGT110408-PM	I60M4×10	WT15IP
1.375	34.93	ZTD05-1.375"-XP1.50"-SP11-02	1.50	1.85	2.76	7.07	11.01	SPGT110408-PM	I60M4×10	WT15IP
1.406	35.71	ZTD05-1.406"-XP1.50"-SP11-02	1.50	1.85	2.76	7.23	11.16	SPGT110408-PM	I60M4×10	WT15IP
1.437	36.50	ZTD05-1.437"-XP1.50"-SP11-02	1.50	1.85	2.76	7.38	11.32	SPGT110408-PM	I60M4×10	WT15IP
1.468	37.29	ZTD05-1.468"-XP1.50"-SP11-02	1.50	1.85	2.76	7.54	11.47	SPGT110408-PM	I60M4×10	WT15IP

F

Indexable insert short hole drills

ZTD05 5D

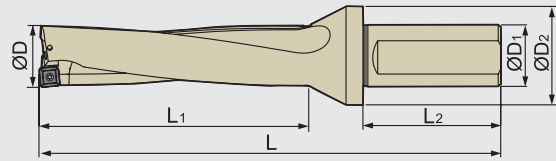

ØD		Type						Applicable inserts	Screw	Wrench
inch	mm		ØD ₁	ØD ₂	L ₂	L ₁	L			
1.500	38.10	ZTD05-1.500"-XP1.50"-SP11-02	1.50	1.85	2.76	7.70	11.63	SPGT110408-PM	I60M4×10	WT15IP
1.531	38.89	ZTD05-1.531"-XP1.50"-SP11-02	1.50	1.85	2.76	7.85	11.79	SPGT110408-PM	I60M4×10	WT15IP
1.562	39.67	ZTD05-1.562"-XP1.50"-SP11-02	1.50	1.85	2.76	8.01	11.94	SPGT110408-PM	I60M4×10	WT15IP
1.594	40.49	ZTD05-1.594"-XP1.50"-SP11-02	1.50	1.85	2.76	8.17	12.10	SPGT110408-PM	I60M4×10	WT15IP
1.625	41.28	ZTD05-1.625"-XP1.50"-SP11-02	1.50	1.85	2.76	8.32	12.26	SPGT110408-PM	I60M4×10	WT15IP
1.687	42.85	ZTD05-1.687"-XP1.50"-SP14-02	1.50	2.24	2.76	8.63	12.96	SPGT140512-PM	I60M5×13	WT20IP
1.719	43.66	ZTD05-1.719"-XP1.50"-SP14-02	1.50	2.24	2.76	8.79	13.12	SPGT140512-PM	I60M5×13	WT20IP
1.750	44.45	ZTD05-1.750"-XP1.50"-SP14-02	1.50	2.24	2.76	8.95	13.28	SPGT140512-PM	I60M5×13	WT20IP
1.781	45.24	ZTD05-1.781"-XP1.50"-SP14-02	1.50	2.24	2.76	9.10	13.43	SPGT140512-PM	I60M5×13	WT20IP
1.813	46.05	ZTD05-1.813"-XP1.50"-SP14-02	1.50	2.24	2.76	9.26	13.59	SPGT140512-PM	I60M5×13	WT20IP
1.875	47.23	ZTD05-1.875"-XP1.50"-SP14-02	1.50	2.24	2.76	9.57	13.90	SPGT140512-PM	I60M5×13	WT20IP
1.937	49.20	ZTD05-1.937"-XP1.50"-SP14-02	1.50	2.24	2.76	9.88	14.21	SPGT140512-PM	I60M5×13	WT20IP
1.969	50.01	ZTD05-1.969"-XP1.50"-SP14-02	1.50	2.24	2.76	10.04	14.37	SPGT140512-PM	I60M5×13	WT20IP
2.000	50.80	ZTD05-2.000"-XP1.50"-SP14-02	1.50	2.24	2.76	10.20	14.53	SPGT140512-PM	I60M5×13	WT20IP

ZTD03/04/05 applicable inserts

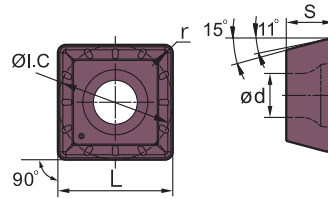

Type	Basic dimension(inch)					Grade	
	L	ØI.C	s	ød	r	YBG205 (peripheral edge)	YBG212 (inner edge)
SPGT050204-PM	0.197	0.197	0.094	0.087	0.016	●	●
SPGT060204-PM	0.236	0.236	0.094	0.102	0.016	●	●
SPGT07T308-PM	0.313	0.313	0.156	0.110	0.031	●	●
SPGT090408-PM	0.386	0.386	0.169	0.165	0.031	●	●
SPGT110408-PM	0.453	0.453	0.187	0.173	0.031	●	●
SPGT140512-PM	0.563	0.563	0.205	0.226	0.047	●	●

● Always stock available ○ Produce according to order

ZTD03/04/05 applicable inserts

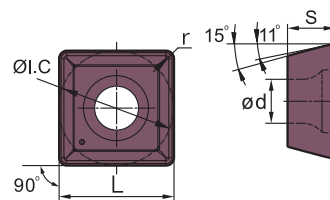

Type	Basic dimension(inch)					Grade	
	L	ØI.C	s	ød	r	YBG205 (peripheral edge)	YBG212 (inner edge)
SPGT050204-EM	0.197	0.197	0.094	0.087	0.016	●	●
SPGT060204-EM	0.236	0.236	0.094	0.102	0.016	●	●
SPGT07T308-EM	0.313	0.313	0.156	0.110	0.031	●	●
SPGT090408-EM	0.386	0.386	0.169	0.165	0.031	●	●
SPGT110408-EM	0.453	0.453	0.187	0.173	0.031	●	●
SPGT140512-EM	0.563	0.563	0.205	0.226	0.047	●	●

suitable for machining viscous materials such as stainless steel.

● Always stock available ○ Produce according to order

● Recommended cutting parameters for shallow drills

ISO	Materials	Hardness HB	Diameter Dc(inch)	Feed rate fn(in/r)	Cutting speed Vc (SFPM)
P	Carbon steel	80-200	0.500-0.906	0.002-0.004	650(550-800)
			0.938-1.187	0.002-0.004	
			1.219-1.500	0.002-0.004	
			1.531-1.813	0.003-0.004	
			1.875-2.000	0.003-0.005	
P	Low alloy steel	150-260	0.500-0.906	0.002-0.004	550(450-700)
			0.938-1.187	0.002-0.005	
			1.219-1.500	0.002-0.006	
			1.531-1.813	0.003-0.006	
			1.875-2.000	0.004-0.008	
P	High alloy steel	150-320	0.500-0.906	0.002-0.004	500(400-600)
			0.938-1.187	0.002-0.005	
			1.219-1.500	0.002-0.006	
			1.531-1.813	0.003-0.007	
			1.875-2.000	0.004-0.009	
P	Cast steel	180-250	0.500-0.906	0.002-0.003	450(400-550)
			0.938-1.187	0.002-0.003	
			1.219-1.500	0.002-0.004	
			1.531-1.813	0.003-0.004	
			1.875-2.000	0.003-0.005	
M	Stainless steel Ferrite Martensite	150-270	0.500-0.906	0.002-0.004	500(360-750)
			0.938-1.187	0.002-0.005	
			1.219-1.500	0.002-0.006	
			1.531-1.813	0.003-0.007	
			1.875-2.000	0.004-0.009	
M	Austenite	150-275	0.500-0.906	0.002-0.004	450(360-700)
			0.938-1.187	0.002-0.004	
			1.219-1.500	0.002-0.005	
			1.531-1.813	0.003-0.006	
			1.875-2.000	0.004-0.006	
K	Malleable cast iron	150-230	0.500-0.906	0.002-0.004	500(400-700)
			0.938-1.187	0.002-0.006	
			1.219-1.500	0.003-0.006	
			1.531-1.813	0.004-0.008	
			1.875-2.000	0.005-0.009	
K	Gray cast iron	150-220	0.500-0.906	0.002-0.004	650(550-800)
			0.938-1.187	0.002-0.006	
			1.219-1.500	0.003-0.006	
			1.531-1.813	0.004-0.008	
			1.875-2.000	0.005-0.009	
K	Nodular cast iron	160-250	0.500-0.906	0.002-0.004	500(400-650)
			0.938-1.187	0.002-0.005	
			1.219-1.500	0.002-0.006	
			1.531-1.813	0.003-0.006	
			1.875-2.000	0.004-0.008	
N	Non ferrous metrls	60-110	0.500-0.906	0.002-0.004	1000(800-1150)
			0.938-1.187	0.002-0.006	
			1.219-1.500	0.003-0.006	
			1.531-1.813	0.004-0.008	
			1.875-2.000	0.005-0.009	



Comparison table for turning insert chipbreaker

Negative inserts

ISO	Machining range	ZCC-CT	SANDVIK	KORLOY	TaeguTec	WALTER	SECO	MITSUBISHI	SUMITOMO	KENAMETAL	DIJET	HITACHI	TUNGALOY	KYOCERA	VALANTE	
P	For extra finishing		QF	HU	FA, EA	NF3	FF1	PK※ FH, FY	FA, FL	UF, FF	F1, FA	FE	01※, TF, ZF	DP※, GP, VF XP, XP-T	F1	
	For finishing	DF	PF MF	HF	FG, SF	NS6	MF2	C, SA, SH	SU, LU, SX	LF, FN	PF, UR UA, UT	BE, CE	NS, 27 TS, AS	HQ, CQ	F2(2B), F5(5C)	
	For finishing (Soft steel)	SF		HF				SY					17	XQ, XS		
	For finishing (Wiper)	WGF	WP WF	HW		NF	W-MF2	SW	LUW	FW			AFW, ASW	WP, WQ		
	For semi-finishing	DM PM	PM QM SM	HA HC HM	MC ML MP	NM4 NM6	MF3 M3 M5	MV MA MH	GU UG UX	MG MN	PG UB	AB AY AE	NM ZM TM DM 37	CJ, GS PS, HS PT, CS	F3, F4(8A), M2(2C), M3 M4, M5(5B), M6, M7, 55, M8	
	For semi-finishing	WGM	WM		WS, WT	NM	W-M3	MW	GUW	MW						
	(Wiper)	DR (Double-side)	PR		MT, MG	NM9	MR7	GH	MU, MX	RN	UD, GG	AR, RE	TH	GT, HT		
	For light roughing	LR, DR (Single-side) HDR, HPR	QR PR HR	HR HH	HT, RH	NR6	R4, R6 R7, PR9	HZ, HX HV	MP, HG HP	MR, RM RH	UC	HX HE	57, 65, TU	HX	R3, R4, R6(9A) R7(9B), R9(9C)	

※ Periphery grinding type

Comparison table for turning insert chipbreaker

Negative inserts

ISO	Machining range	ZCC.CT	SANDVIK	KORLOY	TaeguTec	WALTER	SECO	MITSUBISHI	SUMITOMO	KENNAMETAL	DIJET	HITACHI	TUNGALOY	KYOCERA	VALANTE
M	For finishing	EF	MF	HA	FG, SF	NF4		FS	SU	K, FP		SE	SS	GU	F1, F2(2B), F5(5C)
	For semi-finishing	EM	MM	HS	ML, MP	NM4		MS, ES	EX, UP	P, MP	SF, SG	DE	SA, SM, S	SU, HU, ST	F3, F4(8A), M2(2C), M3, M4, M5(5B), M6, M7, 55, M8
	For roughing	ER	MR	GS, HM	MT, RH	NR4	M5, MR7 56, R6	GH, HZ	MP	RP					R3, R4, R6(9A) R7(9B), R9(9C)
K	For finishing	PM	KF	Without chip-breaker Through	FG	MA		Through chip-breaker,	UZ	FN		Y	CM	Through chip-breaker, C	F2(2B)
	For Semi-Finishing	PM	KM	Through chip-breaker, HM	MC, MT, MG	MA, NIM5		Through chip-breaker,	UX	Through chip-breaker, UN		V	33, through chip-breaker	ZS, GC	M5(5B), M6, M8
S	For roughing	Without chip-breaker	KR	GR, HR, GH	RT, RH	MA		Without chip-breaker	Without chip-breaker					Without chip-breaker	R3, R4, R7(9B)
	For finishing	NF/NGF			SF	NF4	MF1※	FJ※		FS※, K※					F5(5C), M2(2C)
	For semi-finishing	NM	NGP※, 23			NM4	M1	MJ※	SU※	NGP※			SA		M4, M5(5B), M7, 55
	For roughing	SNR	SR			NR4		GJ		MS					

※ Periphery grinding type

Comparison table for turning insert chipbreaker

Positive inserts

ISO	Machining range	ZCC.CT	SANDVIK	KORLOY	TaeguTec	WALTER	SECO	mitsubishi	SUMITOMO	KENNAMETAL	DIJET	HITACHI	TUNGALOY	KYOCERA	VALANTE
P	For finishing	USF, SF, HF	UF, PF	HFP	FA, FG	PF4	FF1 F1	FV, SV	FP, LU SU, SK	11, UF LF		JQ	01※, PF FS	GP, XP VF	PF4 JQ, JZ
	For finishing (Wiper)		WK※, W WP			PF	W-F1	SW	LUW	FW					
	For semi-finishing	HM	UM PM	HMP C25	MT, CMX	PS5 PM5	F2	MV, through chip-breaker	MU	MF	FT	JE	PM 23, 24	HQ, XQ GK	PM2 PM4
	For semi-finishing (Wiper)		WM			PM		MW		MW					
M	For finishing	EF	MF	HFP	FA, FG	PF4		SV					SS※		1A, 2A
	For semi-finishing	EM	MM	HMP C25	MT CMX	PS5 PM5		Through chip-breaker, MV							PM2 PM4
K	For semi-finishing	HM, HR without chip-breaker	KF KM KR	HMP C25	MT CMX	MW PS5 PM5		Without chip-breaker	Without chip-breaker※		FT		Without chip-breaker	Without chip-breaker※	PM2 PM4
	For finishing/ For semi-	NGF				PF4 PS5 PM5		FJ※	SC※	LF※ HP※					PM2, 1A 2A
N	For general turning	LC, LH	AL	TAAK MA	FL	PM2			AG	HP	ALU ACB		PP	A3	1L, 1A 2A

※ Periphery grinding type

CVD coating

Application	ISO Code	ZCC.CT	SANDVIK	KORLOY	TaeguTec	WALTER	mitsubishi	SUMITOMO	TUNGALOY	KYOCERA	DIJET	HITACHI	KENNAMETAL	SECO	ISCAR
Turning	P01	GC4005	GC4205			WAP01	UE6050 UE6105	AC810P AC700G	T9005	CA5505	JC110V	HC5000 HG8010	KCP05 KC9105	TP1000 TK1000	IC428, IC9150 IC8150
		YBC152 YBC151	GC4215 GC4015	NC3010 NC3015	TT1300	WAP10	UE0650, UE6110 UE6020, UC6010 UC6010	AC820P AC2000 AC820P AC810P	T9005 T9015	CA5505 CA5515	JC110V JC215V	HG8010 GM8015 GM10	KCP10 KC9110 TN7005 TN7010	TP1000 TP2000 TK1000 TK2000	IC9150, IC9015, IC8150
	P20	GC4015	GC4225	NC3020	TT1500	WAP20	UC6010 UE6020 UE6010 UE6110	AC2000 AC3000 AC820P	T9015 T9025	CA5515 CA5525 CA5025 CR9025	JC110V JC215V	HG8025 GM8020	KCP25 KC9025 KC9125 TN7015	TP200 TP2000 TK2000	IC9025, IC9250 IC9054, IC8350
		YBC251 YBC252	GC4025 GC4215 LC25	NC3030	TT3500 TT5100	WAP30	UE6035 UH6400 US735	AC830P AC630M AC3000	T9025 T9035	CA5525 CA5535 CR9025	JC215V JC325V	GM25	KCP30 KCP40 KC8050 TN7025	TP300 TP3000	IC9350, IC656, IC8350
	P40	GC4235	GC4035	NC3030	TT450	WAM10	UE6035 UH6400 US735	AC630M	T9035	CA5535	JC325V JC450V	GM8035 GX30	KC9140, KC9040 KC9240, KX9245 TN7035, TPC35	TP3000 TP400 TP40	IC9350 IC635
		YBC351 YBC352	GC2015			WAM20	US7020	AC610M	T9015	CA6515 CA6015	JC110V	GM10	KCM15, TN7010	TP200	IC9250
	M20	YBM151 YBM153 YBM253	GC2025	NC9020	TT2500	WAM20	US7020	AC610M AC630M	T6020 T9025	CA6525 CA6015	JC110V JC215V	GM8020	KC9225 TN7015	TP200	IC9250, IC9025 IC9054
		YBM151 YBM251 YBM253	GC2135 GC235	NC3030	TT3500	WAM30	US735	AC630M	T6030		JC215V JC325V	HG8025 GM25	KCM25 KC8050 TN8025	TP300 TP400 TP40	IC9350 IC9025
	M40	YBM253	GC2025		TT5100	WAM30	US735	AC630M			JC325V JC450V	GX30	KCM35, KC9240 TPC35	TP400 TP40	IC656, IC635 IC9350
		YBD052	GC3205 GC3210			WAK10	UC5005 UC5015	AC300G AC410K	T5010	CA4505 CA4010	JC105V	GM3005	KC05	TK1000	IC9150
	K10	YBD102 YBD152	GC3205 GC3210 GC3215	NC305K	TT1300	WAK10	UC5115 UE6110	AC410K AC700G AC420K	T5010	CA4515 CA4010 CA4115	JC105V JC110V	HG8010 GM8015	KVK15, KCX20 KC9315, KC9110 TN5015	TK1000 TK2000	IC9150, IC9015 IC418, IC428 IC4010
		YBD152 YBD252	GC3215	NC315K	TT1500	WAK20	UC5115	AC700G AC820P	T5020	CA4120	JC110V JC215V	HG8025 GM8020	KCK20, KC9320 TN5020	TK2000 TP200	IC9015

Grades comparison table

CVD coating

Application	ISO Code	ZCC.CT	SANDVIK	KORLOY	TaeguTec	WALTER	mitsubishi	SUMITOMO	TUNGALOY	KYOCERA	DIJET	HITACHI	KENAMETAL	SECO	ISCAR	
Milling	P01															
	P10							ACP100			JC730U		TN2510 TN25M		IC9080 IC4100	
	P	P20	YBM251	GC4020 GC4220			WAP25	FH7020 F7030	ACP100			JC730U		TN7525	T200M T250M	IC520M
		P30	YBM351 YBC302 YBM251	GC4030 GC4230	NCM335	TT7300	WAP35	F7030	AC230	T3030				KC930M	T250M T350M T25M	IC4050
	P40	YBC302	GC4240 GC4040					AC230				GF30 GX2030 GX30				
	M01															
	M10												TN25M			
	M	M20	YBM251 YBM253					F7030				JC730U		TN7525	T350M T25M	IC520M
		M30	YBM351 YBC302	GC2040	NCM335		WTP35	F7030		T3030				KC930M TN7535	T250M T25M	IC4050
	M40	YBC351										GF30 GX30				
	K01										JC600					IC9080
	K	K10	YBD152		NCM310		WAK15	F5010 MC5020	ACK200 AC211	T1015		JC600		TN5505 TN5515		IC4100
		K20	YBD252	GC3220 GC3020 K20D K20W	NCM320		WAK25	F5020 MC5020	ACK200	T1015		JC610		KC915M TN5520	T150M T200M	IC520M IC5100 IC9150
	K30	YBD252	GC3040									JC610		KC930M KC935M	T200M	IC4050 IC520M

Application	ISO Code	ZCC.CT	SANDVIK	KORLOY	TaeguTec	WALTER	MITSUBISHI	SUMITOMO	TUNGALOY	KYOCERA	DIJET	HITACHI	KENAMETAL	SECO	ISCAR	
Turning	P01									PR915 PR1005	JC5003					
	P10	YBG102	GC1525 GC1025				VP10MF		AH710	PR915 PR930 PR1025 RR1115	JC5003		KC5010 KC5510 KU10T	CP200 TS2000	IC250 IC507 IC570	
	P20	YBG202	GC1525 GC1020 GC1025 GC1125	PC230			VP15TF VP20MF		AH710 AH330	PR630 PR915 PR930 PR660 PR1025 RR1225	JC5015		KC5025 KU25T	CP250 TS2500	IC908 IC928 IC1008 IC1028 IC3028	
	P30	YBG202	GC1025 GC1125				VP15TF VP20MF		GH330 GH730 AH120 AH330 AH740	PR630 PR660	JC5015		KC7015 KC7020 KC7235	CP500	IC928 IC1028 IC1008 IC3028	
	P40		GC1020 GC2145	PC240			VP15TF VP20MF		AH120	PR660			KC7040	CP500	IC928 IC1008 IC1028	
	M01									PR915 PR1025						
	M10		GC1005 GC1025 GC1125				VP10MF	AC510N		PR915 PR930 PR1125 PR1225	JC5003		KC5010 KC5510	CP200 TS2000	IC330 IC354 IC507 IC907 IC3028	
	M20	YBG202 YBG205	GC1020 C1025 GC4125	PC9030			VP15TF VP20MF	AC520U	GH330 GH730	PR630 PR915 PR930	JC5015		KC5025 KC730 KC5525	CP200 CP500 TS2500	IC228 IC354 IC250 IC3028	
	M30		GC1020 GC2035 GC2145	PC9030			VP15TF VP20MF	AC520U AC530U	AH120	PR630 PR660	JC5015		KC5025 KC5525	CP500	IC908 IC1008 IC928 IC1028	
	M40							AC530U		PR660						IC228 IC328
	K01							EH10Z	AH110		JC5003					
	K10			PC205K				EH10Z	GH110 AH110		JC5003 JC5015		KC5010 KC5510	CP200 TS2000	IC350	
	K20		GC1020	PC215K			VP10RT VP15TF VP20RT	EH20Z	AH120		JC5015		KC7015 KC7020	CP200 CP250	IC928 IC908 IC1008 IC22	
	K30		GC4125				VP15TF						KC7225	CP500	IC928 IC908 IC1008 IC22	
	S01		GC1105				VP05RT		AH110	PR915	JC5003				IC507	
	S10	YBG102 YBG105 YBG202	GC1005 GC1025 GC1125				VP05RT VP10RT	AC510U	AH120	PR915 PR1125	JC5015		KC5410 KC5010	CP200 CP250	IC903	
S20	YBG212	GC4125				VP10RT VP15TF	AC510U AC520U		PR915			KC5025 KC5525	CP250 CP500	IC300 IC808 IC928		
S30		GC1125 GC2145				VP15TF	AC520U		PR1125							

Grades comparison table

Application	ISO Code	ZCC.CT	SANDVIK	KORLOY	TaeguTec	WALTER	MITSUBISHI	SUMITOMO	TUNGALOY	KYOCERA	DIJET	HITACHI	KENAMETAL	SECO	ISCAR			
Milling	P	P01						ACP100			JC5003	PTH08M PCA08M PCS08M TB6005 JX1005						
			P10						ACZ310 ACP100 ACP200		PR730 PR830 PR1025 PR1225	JC5003 JC5030	PCA12M TB6005 JX1020 PC20M	KC715M		IC250 IC903 IC950		
				P20		GC1010 GC1025					ACZ310 ACZ330 ACP200		PR630 PR730 PR830 PR660 PR1025 PR1225	JC5015 JC5030 JC5040	TB6020 CY150 JX1015	KC522M KC525M	F25M MP3000	IC950 IC900 IC908 IC910
			P30			GC1010 GC1030 GC2030	PC230			VP15TF	ACZ300 ACZ350 ACZ200		PR630 PR660 PR730 PR830 PR1230	JC5015 JC5040	TB6045 CY250 CY25 HC844 JX1045 PTH30E	KC725M	F25M, F30M MP3000	IC900 IC928 IC300 IC328 IC1008
					P40		GC1010 GC1030	TT7030 TT7070 TT9030			ACZ350 ACP300	AH120	PR660 PR1230	JC5040	PTH30E TB6060 PTH40H	KC735M	F40M, T60M	IC900 IC928 IC300 IC328
	M	M01											PCS08M					
		M10							ACP200		PR630 PR730 PR830	JC5003 JC5020 JX1020		KC715M		IC903		
			M20							ACZ310 EH20Z ACP300	GH330	PR630 PR730 PR830 PR660	JC5015 JC5030 JC5040	TB6020 CY150 JX1015	KC730 KC522M KC525M	F25M MP3000	IC900 IC903 IC908 IC928	
		M30			GC1040 GC2030	PC9530	TT8020 TT8030		VP15TF VP20RT VP30RT	ACZ330 EH20Z ACZ350	AH120	PR630 PR660 PR730 PR830 PR1225	JC5015 JC5030 JC5040	TB6045 CY250 HC844	KC725M KC735M	F30M F40M	IC928 IC328 IC1008	
				M40						ACZ350 ACP300	AH140	PR660	JC5015	TB6060 PTH40H JX1060			IC928 IC328	

Grades comparison table

Application	ISO Code	ZCC-CT	SANDVIK	KORLOY	TaeguTec	WALTER	mitsubishi	SUMITOMO	TUNGALOY	KYOCERA	DIJET	HITACHI	KENAMETAL	SECO	ISCAR
Milling	K	K01							AH110	PR510 PR905	JC5003	PTH08M PCA08M PCS08M			
		K10	YBG102 YBG252	GC1010		WXH15 WXM15		ACZ310 ACK200	AH110 GH110	PR510 PR905	JC5003	CY9020 TB6005 CY100H	KC510M		IC900 IC910
		K20	YBG152	GC1010 GC1020	PC215K	TT6030		VP15TF VP20RT	ACZ310 ACK200	AH120	PR510 PR905	JC5015	TB6020 CY150 PTH13S	KC520M KC525M	MK2000
	K30		GC1020				VP15TF VP20RT	ACZ330 ACK300			JC5015	TB6045 CY250 PTH40H	KC725M KC735M		IC908 IC950 IC928
	S01										JC5003				
	S10	YBG202	GC1025		TT6030		VP15TF	EH520Z	AH120	PR660	JC5015	PCS08M	KC510M		IC908
	S20		GC1025		TT8020	WXM35	VP15TF	EH520Z EH20Z		PR660		CY100H CY10H	KC522M KC525M		IC908
	S30		GC2030 S30T		TT8030 TT9030			ACK300		PR660			KC725M	F40M	IC328 IC928
	H01										JC5003				IC903
	H10		GC1010 GC1030			WXH15	VP15TF				JC5015	PTH08M PCA08M JX1005	KC635M	MH1000 F15M	IC900
	H20		GC1010			WXP45	VP15TF						KC635M	F15M	IC1008 IC808
	H30		GC1030										KC530M	F30M MP3000	IC1008 IC908

Grades comparison table

Application	ISO Code	ZCC.CT	SANDVIK	KORLOY	TaeguTec	WALTER	MITSUBISHI	SUMITOMO	TUNGALOY	KYOCERA	DIJET	HITACHI	KENAMETAL	SECO	ISCAR		
Turning	P	P01		CC105 CN100			AP25N	T110A T2000Z	NS520 AT520 GT520 GT720	TN30 PV30	LN10 CX50				IC20N IC520N		
				CC15 CN200 CT10	PV3010	AP25N NX2525	T1200A T2000Z	NS520 AT530 GT720 GT730	TN60 PV60 TN6020 PV7020	CX50 CX75	CZ25	KT125 KT315	CM CMP			IC20N IC520N IC530N	
		P20		GC1525	CT3000	AP25N UP35N NX2525 NX3035	T1200A T2000Z T3000Z	NS530 GT530 GT730 NS730	TN10 TN6020 PV90 PV7020	CX75	CH550	KT5020 KT325 KT1120				IC20N IC30N IC520N IC530N	
			P30			VP45N	T3000Z	NS530 NS730									IC75T IC30N
	M	M01															
			M10	YNG151 YNG151C	GC1525	PV3010	NX2525 AP25N	T110A T2000Z	NS520 AT530 GT530 GT720	TN60 TN6020 PV60 PV7020	LN10 CX50		KT125	CM CMP			
		M20				CT3000	NX2525, AP25N NX3035	T1200A T2000Z	NS530 GT730 NS730	TN90 TN6020 PV90 PV7020	CX50 CX75	CH550					
			M30					T3000Z									
		K	K01			CC105 CN100			AP25N NX2525	T110A T2000Z	NS520 AT520 GT520 GT720	TN30 PV30	LN10				
				K10	YNG151 YNG151C	CT5015	CT3000	AP25N NX2525	T1200A T2000Z	NS520 GT530 GT730 NS730	TN60 PV60 TN6020 PV7020	LN10		KT325 KT125			
K20						AP25 NX2525	T3000Z					CX75					

Grades comparison table



Application	ISO Code	ZCC.CT	SANDVIK	KORLOY	TaeguTec	WALTER	MITSUBISHI	SUMITOMO	TUNGALOY	KYOCERA	DIJET	HITACHI	KENAMETAL	SECO	ISCAR
Milling	P01														
	P10	YNG151 YNG151C		CN100	CT3000		NX2525			TN60	CX75			C15M	IC30N
	P20		CT530	CN20	CT520		NX2525		NS530	TN100M	CX75 CX90	CH550 CH7030 MZ1000 MZ2000	KT530M HT7 KT605M	C15M	IC30N
	P30			CN30			NX4545	T250A	NS530 NS540 NS740		CX90 CX99	MZ3000 CH7035			IC30N
	M01														
	M10	YNG151 YNG151C			CT3000		NX2525			TN60					IC30N
	M20		CT530		CT520		NX2525		NS530	TN100M	CX75	CH550 CH7030 MZ1000 MZ2000	KT530M HT7 KT605M	C15M	IC30N
	M30						NX4545	T250A	NS540 NS740		CX90 CX99	MZ3000 CH7035			
	K01														
	K10	YNG151 YNG151C			CT520		NX2525		NS530	TN60					
	K20						NX2525				CX75		KT530M HT7		
	K30														

Grades comparison table

PCBN grade

Application	ISO Code	ZCC.CT	SANDVIK	KORLOY	TaeguTec	WALTER	MITSUBISHI	SUMITOMO	TUNGALOY	KYOCERA	DIJET	SECO	Element Six	
Turning	H	H01			WCB30	MBC010 MB810	BNX10 BNC30	BXM10 BX310 BXC30				CBN050C CBN100		
		H10	YCB012	CB7015 CB7020 CB20	KB320 KB330 KB420	KB90 KB90A	WCB50	MBC020 MB8025 MB820	BNC80 BNX20 BNC160	BXM20 BX330 BXA30	KBN510	JBN300	CBN10 CBN200	DBC50
		H20		CB7025 CB7050 CB50			MBC020 MB8025 MB825	BN250 BNC200 BNX25	BXC50		KBN525	JBN245	CBN150 CBN200	DBN45
		H30				MBC020 MB835	BNC300 BN350	BX380					CBN300 CBN350	
		S01	YCB011			MB730	BN600 BN700	BX450 BX950 BX480						
		S10												
		S20												
		S30												
		K01					MB710	BN500	BX930				CBN300 CBN300P	
		K10	YCB011 YZB221	CB50 CB7050	KB350 KB360	KB90 KB90A	WCB50	MB710 MB730	BN700	BX480 BX950	KBN65B	JBN795	CBN200	DBA80
		K20	YZB221					MB730 MBS140	BN700 BNS800	BXC90	KBN900	JBN330	CBN300	
		K30					MBS140	BNS800	BXC90				CBN350	

PCD grade

Application	ISO Code	ZCC.CT	SANDVIK	KORLOY	TaeguTec	WALTER	MITSUBISHI	SUMITOMO	TUNGALOY	KYOCERA	DIJET	SECO	Element Six
Turning	N	N01					MD205	DA90	DX180	KPD001 KPD025	JDA735	1700 1800	CTH025
		N10	YCD011	DP90 DP150 DP200	KB500	WCD10	MD205 MD220	DA150	DX160	KPD010	JDA745	1500	CTB010
	N20					MD220 MD230	DA200 DA2200	DX140 DX120	KPD002 KPD230	JDA715 JDA10	1300	CTB002	
	N30					MD230	DA1000 DA2200		KPD001		1600		

Cemented carbide material

Application	ISO Code	ZCC-CT	SANDVIK	KORLOY	TaeguTec	WALTER	MITSUBISHI	SUMITOMO	TUNGALOY	KYOCERA	DIJET	HITACHI	KENNAMETAL	SECO	ISCAR
Turning	P01			ST05											
	P10	YC10	S1P	ST10	P10			ST10P	TX10S		SRT	WS10	P10		IC70
	P20		SMA	ST20	P20		UT120T	ST20E	TX20 TX25		SRT	EX35	K125M TTM		IC70 IC50M
	P30		SM30	ST30A	P30		UT120T	A30 A30N	TX30 UX30	PW30	SR30	EX35 EX40	GK K600 TTR		IC50M IC54
	P40	YC40	S6					ST40E	TX40		SR30	EX45	G13		IC54
	M10		H10A	U10	M10			EH510 U10E	TU10		UMN	WA10B	K313	890	
	M20		H13A	U20	M20		UT120T	EH520 U2	TU20 UX30		DX25	EX35	K68 KMF K125M TTM	HX 883	IC08
	M30		H10F SM30	ST30A			UT120T	A30 A30N	UX30		DX25	EX40 EX45	K600 TTR		IC08 IC28
	M40		S6	U40	M40				TU40		UM40	EX45	G13		IC128
	K01	YD051	H1P	H02			UT105T	H1 H2	TH03 KS05F		KG03	WH05	K605		
	K10	YD201	H1P H10 HM	H01	K10		HT110	EH10 EH510	G1F TH10	KW10	KG10	WH10	K313 K110M THM THM-U	890	IC20
	K20	YD201	H13A	G10	K20		UT120T	G10E EH20 EH520	G2F KS15F G2 KS20	GW10	CR1	WH20	K715 KMF K600	890 HX 883	IC20 IC10
	K30			G3			UT120T	G10E	G3		KG30		THR	883	IC10 IC28
	N01		H10 H13A					H1 H2	KS05F		KG03		K605		
	N10	YD101		H01	K10	WK10	HT110	EH10 EH510	TH10 H10T		KG10	KT9	K313 K110M THM THM-U	890 H15	
	N20				K20			G10E EH20 EH520	KS15F		CR1	KG20	K715 KMF K600	HX KX 883 H15 H25	
	N30										KG30		G13 THR	H25	
	S01						RT9005				KG03				
	S10	YD101	H10 H10A H10F H13A	H01	K10		RT9005 RT9010	EH10 EH510	KS05F TH10		FZ05	KG10	K10 K313 THM	890	
	S20						RT9010 TF15	EH20 EH520	KS15F KS20		FZ15	KG20	K715 KMF	890 883 HX H25	
S30						TF15				KG30		G13 K600 THR			

Grades comparison table

Cemented carbide material

Application	ISO Code	ZCC.CT	SANDVIK	KORLOY	TaeguTec	WALTER	MITSUBISHI	SUMITOMO	TUNGALOY	KYOCERA	DIJET	HITACHI	KENAMETAL	SECO	ISCAR		
Milling	P	P10	S1P								SRT						
		P20		ST20	P10		UT120T	A30N	TX25		SRT DX30	EX35	K125		IC50M IC28		
		P30		ST30A	P20		UT120T	A30N	UX30		SR30 DX30	EX35 EX40	GX K600		IC50M IC28		
		P40	YC30S	ST40	P30						SR30	EX45			IC28		
	M	M10		U10	M10							UMN		K110M			
		M20		U20	M20			UT120T	A30N			DX25 UMS	EX35	K313			
		M30	YC30S					UT120T	A30N	UX30		DX25 UMS	EX40 EX45	KFM K600		IC28	
		M40		U40	M40					TU40			EX45			IC28	
	K	K01	YD051	H01				UT105T				KG03					
		K10	YD051	H05 H10	K10		WK10	HT110	G10E	TH10	KW10	KG10	WH10	K110M K313		IC20	
		K20	YD201	G10	K20			UT120T	G10E			KT9 CR1 KG20	WH20	KFM	HX	IC20 IC10	
		K30							UT120T				KG30				IC10 IC28

Insert index

A

APKT-ALH	253
APKT-APF	253
APKT-APM	253
ANGX	267

C

CCGT-SF	58
CCGW	87
CCGW-2	87
CCGX-LC	59
CCGX-LH	59
CCMT-EF	58
CCMT-EM	59
CCMT-HF	58
CCMT-HM	58
CCMT-HR	59
CNEG-NF	30
CNGA	78
CNGA-2	78
CNGN	79
CNMA	34
CNMG	34
CNMG-DF	30
CNMG-DM	31
CNMG-DR	32
CNMG-EF	30
CNMG-EM	32
CNMG-ER	33
CNMG-NM	32
CNMG-PM	31
CNMG-SF	30
CNMG-SNR	33
CNMG-WGF	30

CNMM-DR	33
CNMM-ER	33
CNMG-WGM	32
CPGT-SF	70

D

DCGT-SF	60
DCGW	89
DCGW-2	89
DCGX-LC	61
DCGX-LH	61
DCMT-EF	60
DCMT-EM	60
DCMT-HF	60
DCMT-HM	60
DCMT-HR	61
DNEG-NF	36
DNEG-NGF	36
DNGA	80
DNGA-2	80
DNGN	81
DNMG-DF	35
DNMG-DM	38
DNMG-DR	39
DNMG-EF	36
DNMG-EM	38
DNMG-ER	39
DNMX-WGF	35
DNMX-WGM	37
DNMG-NM	39
DNMG-PM	37
DNMG-SF	35
DNMG-SNR	40
DNMM-DR	39

DNMM-ER	40
DPGT-SF	71

O

OFKR-DF	209
OFKR-DM	209
OFKT-DF	206
OFKT-DM	206
OFKT-LH	206
ONHU-GM	218

P

PNEG-CF/CM/CR/PF/PM/PR	222
PNGU-GR	227

R

RCKT-DM	243
RCKT-DR	243
RCKT-ER	243
RCKT-NM	243
RDKW	245
ROHX	269
RPMW	250

S

SCGX-LC	63
SCGX-LH	63
SCMT	63
SCMT-EF	62
SCMT-EM	62
SCMT-HF	62
SCMT-HM	62
SCMT-HR	62
SDMT-DM/PM/NM	276
SEET□PER-APF	233
SEET□PER-APM	233

Insert index

SEETOPER-APR.....	233
SEK(E)N	203
SEKR	203
SNEG-HGM/GR/-W	214
SNGN	82
SNGN	46
SNMA	45
SNMG.....	45
SNMG-DF	41
SNMG-DM.....	42
SNMG-DR	43
SNMG-EF	41
SNMG-EM	42
SNMG-ER	44
SNMG-NM.....	42
SNMG-PM	41
SNMG-SF	41
SNMG-SNR	44
SNMM	45
SNMM-DR.....	43
SNMM-ER	44
SPGT-PM/EM	392
SPMT	283

T

TCGW	90
TCGX-LC	65
TCGX-LH	66
TCMT	66
TCMT-EF	64
TCMT-EM	64
TCMT-HF	64
TCMT-HM	65
TCMT-HR	65

TNGA	83
TNGA-3	83
TNMA	51
TNMG.....	50
TNMG-DF	47
TNMG-DM	48
TNMG-DR	49
TNMG-EF	47
TNMG-EM	49
TNMG-ER	49
TNMG-PM	48
TNMG-SF	47
TNMG-SNR	50
TNMM.....	51
TNMM-DR	49
TNMX-WGF	47
TNMX-WGM	48
TPGH	72
TPGT-SF	72
TPKN	231

V

VBGW	92
VBGW-2.....	92
VBMT-EF	69
VBMT-EM	69
VBMT-HF	69
VBMT-HM	69
VBMT-HR	69
VCGT-HF	67
VCGT-SF	67
VCGW	93
VCGX-LC	68
VCGX-LH	68

VNEG-NF	52
VNEG-NGF	52
VNGA.....	84
VNGA-2	84
VNMG.....	53
VNMG-DF	52
VNMG-DM.....	53
VNMG-EF	52
VNMG-EM	53
VNMG-NM.....	53
VNMG-PM	53
VNMG-SF	52
VNMG-SNR	53

W

WNEG-NF	55
WNGA-3.....	85
WNMA	57
WNMG-DF.....	54
WNMG-DM	55
WNMG-DR	57
WNMG-EF	55
WNMG-EM	56
WNMG-NM	56
WNMG-PM	56
WNMG-SF	54
WNMG-SNR	57
WNMG-WGF.....	54
WNMG-WGM	55
WPGT-PM	279

Z

RT□□□□W-□□□GM	154
RT□□□□N-□□□GM	155
RT□□□□N-A(G)(N)□□(P*)...	156

Insert index

RT□□□□W(N)-□□W	157	RT□□□□W(N)-□□WB.....	170	ZOHX-GF	271
RT□□□□W(N)-□□UN	158	RT□□□□W(N)-□□UNB	171	ZOHX-GM	272
RT□□□□W(N)-□□BSPT.....	159	RT□□□□W(N)-□□BSPTB ...	172	ZPOD-MG	127
RT□□□□W(N)-□□□NPT ...	160	RT□□□□W(N)-□□□NPTB...	173	ZPOS-MG	127
RT□□□□W-□□UNJ.....	161	LT□□□□W-□□□GM	154	ZROD-EG	131
RT□□□□W(N)-□□AC	162	LT□□□□N-□□□GM.....	155	ZROD-MG.....	130
RT□□□□W(N)-□□STAC.....	163	LT□□□□N-A(G)(N)□□(P*) ...	156	ZROD-NM	130
RT□□□□W(N)-□AP□□□ ...	164	LT□□□□W(N)-□□W	157	ZTOD-EG	129
RT□□□□W(N)-□□RD	165	LT□□□□W(N)-□□UN	158	ZTOD-EG	129
RT□□□□W-□BUTO.....	166	LT□□□□W(N)-□□BSPT	159	ZTOD-MG	128
RT□□□□W-□□□GMB	167	LT□□□□W(N)-□□□NPT.....	160	ZTOD-MM	128
RT□□□□N-□□□GMB.....	168	ZIMF-SM	129	ZTOS-MG	128
RT□□□□W-A(G)□□B	169	ZIGQ-NF	131		

Tool index

1588SL12/20/30C	371-376	DCLNR/L	96	FMA01	198
A		DDJNR/L	97	FMA02	199
AL-2B	305	DSBNR/L	97	FMA03	202
AL-2E	304	DTGNR/L	98	FMA04(OFKT05□□)	205
AL-3E	304	DVJNR/L	99	FMA04(OFKR07□□)	208
AL-2R-ALR	305	DVVNN	98	FMA11	212-213
B		DWLNR/L	99	FMA12	217
BMR02	268	E		FMD02(PN11)	220-221
BMR04	270	EMP01	251-252	FMD03	224
C		EMP02	257	FMD04	226
CMA01	281	EMP03	260	FME04	228
CMD01	282	EMP04	261	FMP01	230
D		EMP13	265-266	FMP02	232
		F		FMP03	235

Tool index

FMP12	237-238
FMR01	240
FMR02	242
FMR03	244
FMR04	246
FMR05	248-249

G

GD03	338-366
GD03C	338-366
GD05	338-366
GD05C	338-366
GD08C	338-366
GM-2B	296
GM-2BL	296
GM-2E	293
GM-2EL	293
GM-2ES	298
GM-2R	298
GM-3E	294
GM-3EL	294
GM-4B	297

GM-4BL	297
GM-4E	295
GM-4EL	295
GM-4R	299
GM-4W	299

H

HMX-2B	303
HMX-2BL	303
HMX-4E	302
HMX-4EL	302

M

MCLNR/L	100
MDJNR/L	100
MTJNR/L	101
MTJNR/L□□-Z.....	101
MVJNR/L	102
MWLNR/L	102

S

SCLCR/L	103
SCLCR/L	112

SDJCR/L	103
SDUCR/L	113
STFCR/L	114
STGCR/L	106
SVJBR/L	104
SVJCR/L	105
SVVBN	104

U

UM-4E	308
UM-4EL	308

V

VSM-4E	310
VSM-4EFP.....	311
VSM-4RFP	312

X

XMR01	274-278
-------------	---------

Z

ZTD03/04/05	386-391
-------------------	---------



Safety & environmental protection

Cemented carbide products are hard and brittle. They are easily damaged by improper handling and clamping. Be careful when using carbide tools.

When cutting with carbide tools, cooling liquids may be used, and workpiece materials will be formed into chips during the machining process. Both the cooling agent and the chips need to be handled carefully. Protective measures need to be taken to protect individuals, at or near, the work area.

The use of ventilating equipment, protective machine shields, safety glasses, protective clothing, appropriate ear protection, and other relevant forms of safety protection, is recommended.

Please consult your material safety data sheet (MSDS) for further information.

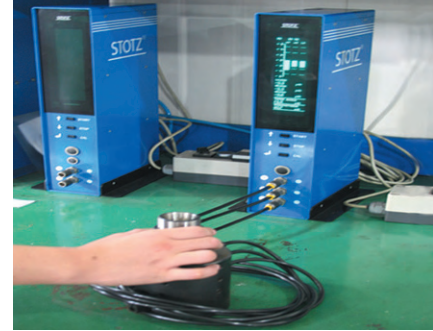
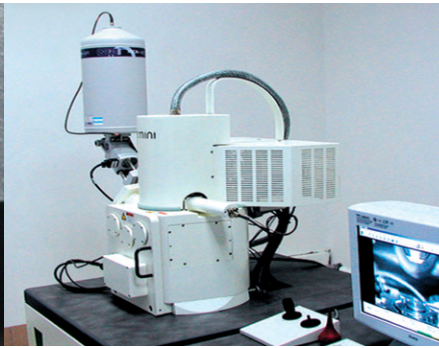
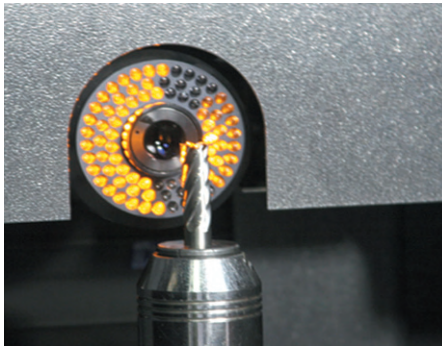

Quality guarantee

We have been awarded GB/T19001-ISO9001 Quality System Certificate. All our products are inspected strictly.

ZCC USA Inc.

Zhuzhou Cemented Carbide Cutting Tools Co. Ltd (ZCCCT) is the most technologically advanced metal cutting tool company in China, and one of the most advanced in the entire world. Our research and development and manufacturing departments are regularly introducing new products through constant improvement. Combining the latest manufacturing equipment on a huge production scale, and a strong technical organization, ZCCCT is fast becoming the most recognized world-class supplier of indexable and solid carbide tools.

Beginning with the cutting tool material, we strictly control each process systematically, and implement the required management necessary to insure the continuity of product quality. Our research and development people constantly engineer into each of our tools, the latest developments in tool materials and metal cutting technology, in order to provide customers with the highest quality, highest value, and the most highly productive products available anywhere in the world. Our sales and distribution network spans the globe. Look to ZCCCT for productivity improvement and reduced manufacturing costs.

36 22 W.Liberty Rd. Ann Arbor, MI 48103
Tel: 734-997-3811 Fax: 734-997-3820
E-Mail: sales@zccusa.com
[Http://www.zccusa.com](http://www.zccusa.com)

